

Logger1000A_B-UEN-Ver15-202107 Version:1.5

Logger1000A/Logger1000B

Data Logger

User Manual

SUNGROW

Contents

1 About this Manual	1
1.1 Intended Use.....	1
1.2 Target Group.....	1
1.3 How to Use This Manual.....	1
1.4 Symbol Explanations.....	2
2 Safety Instruction	3
3 Product Introduction	5
3.1 Function Description	5
3.1.1 Brief Product Introduction	5
3.1.2 Networking Application.....	5
3.2 Appearance	7
3.3 Dimensions	8
4 Installation Flow	9
5 Unpacking and Storage	10
5.1 Scope of Delivery	10
5.2 Identifying the Logger1000	11
5.3 Checking upon Receiving.....	11
5.4 Storage.....	12
6 Mechanical Installation	13
6.1 Installation Location Selection	13
6.2 Installation Tools.....	14
6.3 Installing Logger1000.....	14
6.3.1 Wall-Mounted Installation	14
6.3.2 Guide Rail-Mounted Installation	16
6.4 Installing Antenna.....	17
6.5 Installing Power Box	18
7 Electrical Connection	20
7.1 Safety Instructions.....	20
7.2 Port Introduction.....	20
7.3 Connection to PV Devices	21

7.3.1	Connection to a single inverter	21
7.3.2	Connection to multiple devices	24
7.3.3	Connection to Smart Energy Meter	24
7.3.4	Connection to Meteo Station.....	26
7.4	Connection to Background.....	27
7.5	Connection to Micro-SIM.....	28
7.6	Connection to Power Box	28
7.7	Cable Routing Requirements	30
8	Commissioning	32
8.1	Inspection before Commissioning	32
8.2	Commissioning Steps.....	32
9	Web Interface	35
9.1	Running Requirements	35
9.2	Login Steps.....	35
9.2.1	WiFi Login	35
9.2.2	Ethernet Login	36
9.3	Web Main Interface.....	36
9.4	Web Menu	37
9.5	Operation Procedure	38
9.6	Overview.....	39
9.6.1	General Information.....	39
9.6.2	Current Alarms	39
9.7	Device Monitoring	40
9.7.1	RealTime Values	40
9.7.2	DC Data.....	40
9.7.3	Initial Parameter.....	40
9.7.4	Protection Parameter.....	41
9.7.5	General Parameter	41
9.7.6	Device Instruction	41
9.7.7	Device Information	42
9.8	Device Maintenance	42
9.8.1	Device List.....	42
9.8.2	Firmware Update.....	47
9.8.3	Inverter Log	47
9.8.4	AFCI Activation.....	48
9.9	History Data	48

9.10 System	48
9.10.1 Running Information	48
9.10.2 System Maintenance	48
9.10.3 Remote Maintenance	49
9.10.4 Message Export	50
9.10.5 System Time.....	51
9.10.6 iSolarCloud.....	52
9.10.7 IEC104.....	53
9.10.8 MODBUS.....	56
9.10.9 Third-party portal.....	57
9.10.10 Port Parameter	57
9.10.11 About	59
10 Grid Dispatching Function	60
10.1 Function Description	60
10.2 Interface Description	61
10.2.1 Digital Control Interface	61
10.2.2 Analog Control Interface	62
10.2.3 DRM Control Interface	63
10.3 Power Control	63
10.3.1 Active Power	63
10.3.2 Reactive Power	70
10.3.3 Emergency Button.....	76
11 Device Maintenance	77
11.1 Safety Instructions.....	77
11.1.1 Safety Rules	77
11.1.2 Five Safety Rules.....	77
11.2 Maintenance.....	77
11.3 Troubleshooting	78
12 Appendix	81
12.1 Technical Data	81
12.2 Dry Contact Wiring Cable	82
12.3 Quality Assurance	82
12.4 Contact Information	83

1 About this Manual

This manual is valid for the following data loggers researched and manufactured by Sungrow Power Supply Co., Ltd.

- Logger1000A (4G version)
- Logger1000B (non-4G version)

The foregoing Loggers are referred to as the "Logger1000" for short unless otherwise specified.

1.1 Intended Use

This manual is intended to provide users with detailed information on the Logger1000 as well as installation, operation, and maintenance description.

1.2 Target Group

This manual is applicable to technical personnel who are responsible for the installation, operation and maintenance of the Logger1000 and to users who need to perform daily operation. Readers should have some electrical knowledge and be familiar with electrical principles and electrical components. This manual does not cover the electrical connections of the inverter and the Meteo Station or related safety instructions. For the details of the electrical connections of these devices, refer to the corresponding manuals.

1.3 How to Use This Manual

Read this manual carefully before performing operation on the device. This manual must be stored at hand and available at all times.

All rights reserved including the pictures, symbols, and markings used in this manual. Any reproduction or disclosure, even partially, of the contents of this manual is strictly prohibited without prior written authorization of SUNGROW. The content of the manual will be periodically updated or revised as per the product development. It is probably that there are changes in manuals for the subsequent module edition. If there any mismatch between the product and its manual, the actual product shall prevail and the manual of the latest version can be obtained from SUNGROW.

1.4 Symbol Explanations

This manual contains important safety and operational instructions that must be accurately understood and respected during the installation and maintenance of the equipment.

To ensure the optimum use of this manual, note the following explanations of the symbols used.

DANGER

DANGER indicates a hazard with a high level of risk which, if not avoided, will result in death or serious injury.

WARNING

WARNING indicates a hazard with a medium level of risk which, if not avoided, could result in death or serious injury.

CAUTION

CAUTION indicates a hazard with a low level of risk which, if not avoided, could result in minor or moderate injury.

NOTICE

NOTICE indicates a situation which, if not avoided, could result in equipment or property damage.



NOTE indicates additional information, emphasized contents or tips to help you solve problems or save time.

2 Safety Instruction

This chapter mainly introduces safety instructions that need to be respected during the operation of Logger1000.

The Logger1000 has been designed and tested strictly according to international safety regulations. As electrical and electronic equipment, the Logger1000 must be installed, commissioned, operated, and maintained in strict accordance with related safety instructions.

Incorrect operation or work may cause:

- injury or death to the operator or a third party;
- damage to the Logger1000 and other properties.

Therefore, the following safety instructions must be read and always kept in mind prior to any work. All detailed work-related safety warnings and notes will be specified at the critical points in corresponding chapter.

WARNING

All operation and electrical work must only be performed by qualified personnel.

Before Installation

NOTICE

After receiving the device, please check if there is damage caused during transport. Contact SUNGROW or the forwarding company once any problem is detected.

The related operators must be familiar with the safety instructions in this manual and other safety regulations about the installation, operation and maintenance of the Logger1000.

Move, transport, install, operate, and maintain the Logger1000 correctly and appropriately.

During Installation

NOTICE

The Logger1000 can only be used as described in this manual. Altering the product without authorization or using spare parts not sold or recommended by SUNGROW may lead to fire, electric shock or other damages.

NOTICE

Disconnect all electrical connections and the upstream input switch and make sure the Logger1000 is voltage-free during installation.

NOTICE

Disconnect the upstream input switch and make sure the Logger1000 is voltage-free before electrical connections.

Maintenance and Replacement**⚠ WARNING**

The maintenance of the Logger1000 can only be performed by qualified personnel from service dept. of SUNGROW or other qualified personnel. User can never maintain or replace the modules and other parts. Serious personal injury or property loss may follow if otherwise.

NOTICE

Never replace the internal components of the Logger1000 without authorization. SUNGROW shall not be held liable for any possible damage caused by ignorance of this warning.

3 Product Introduction

3.1 Function Description

3.1.1 Brief Product Introduction

The Logger1000 is a device used for data collection, power control, and protocol conversion for inverters and other PV equipment in the PV plant. The device is also integrated with communication gateway and plant O&M function.

The Logger1000 is featured as flexible networking, auxiliary maintenance, and easy operation.

Flexible networking

- Support of RS485, Ethernet, and WiFi communication
- Support of data collection from various environment sensors, Smart Energy Meters, Meteo Stations, inverters, and other equipment

Auxiliary maintenance

- Support of batch inverter parameter setting and software upgrading
- Support of remote desktop function, lower maintenance costs
- Support of grid control instruction and power factor control
- Support of local real-time monitoring, unnecessary to connect the Internet

Easy operation

- Auto search and allocation of inverter address
- Embedded web operation interface, support of mobile phone access, free download of the App

3.1.2 Networking Application

As shown in the figure below, the Logger1000 can be connected to iSolarCloud via an ethernet switch.

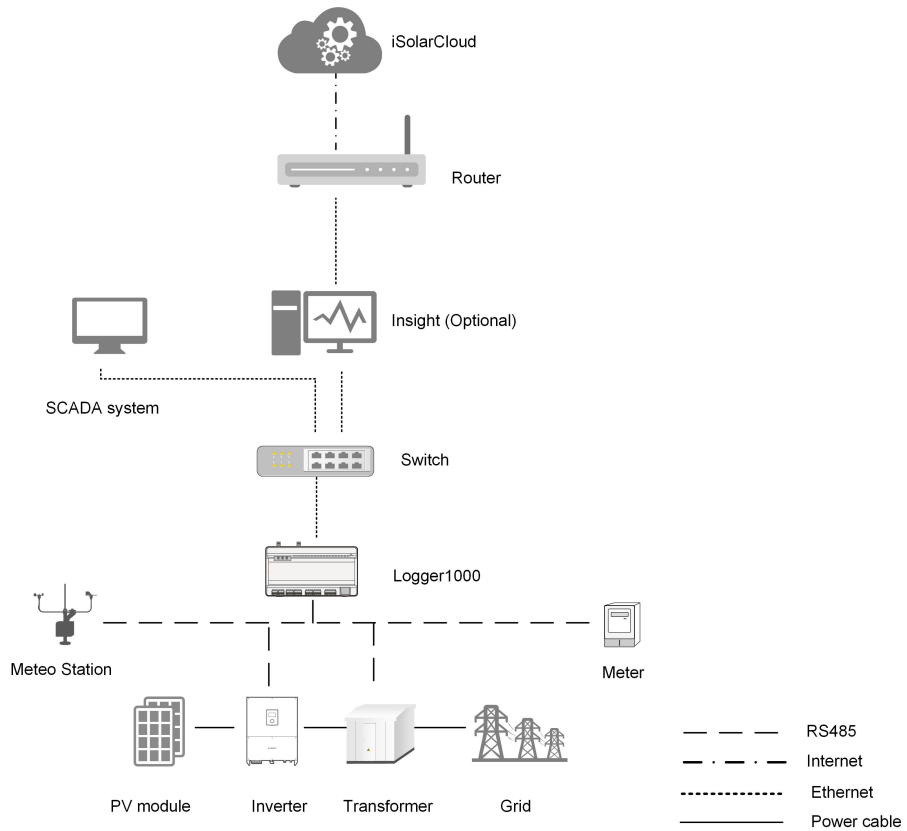

The Logger1000 can be connected to iSolarCloud via the router or connected to the iSolarCloud via the WiFi or 4G network.

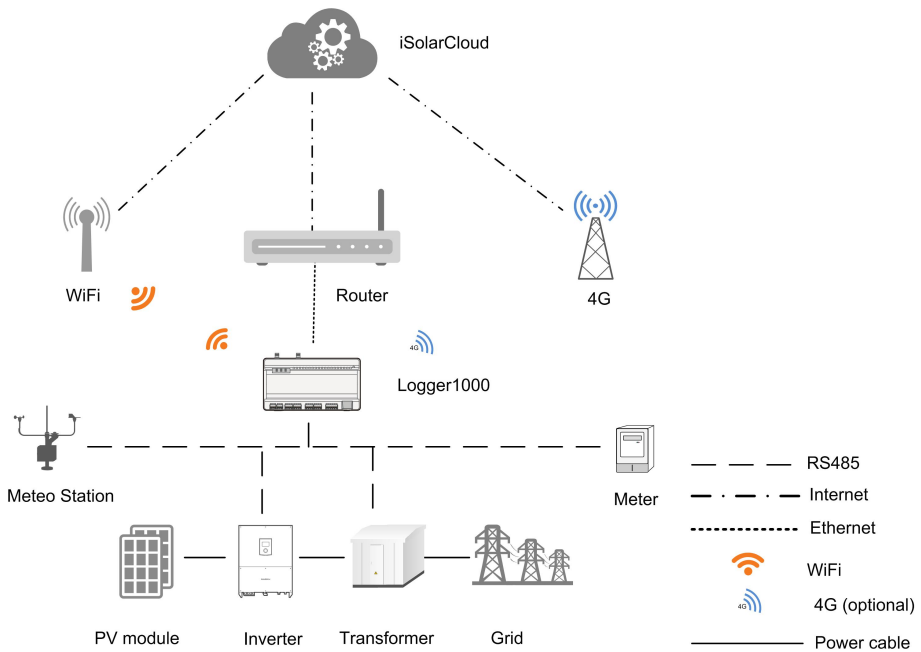

- The Logger1000 supports various communication manners such as WiFi and 4G.
- The Logger1000 can be connected to various environment sensors, Smart Energy Meters, Meteo Stations, and inverters in the PV power generation system via an RS485 bus.
- Users can access the Web interface via mobile phone or PC, on which parameter configuration and remote on-line upgrading can be performed.
- The Logger1000 can transmit data to iSolarCloud and forward background instructions to downstream devices.
- The Logger1000 is equipped with grid dispatching function, including active power control, reactive power regulation, etc.

3.2 Appearance

Views of the Logger1000 are shown in the following figure.

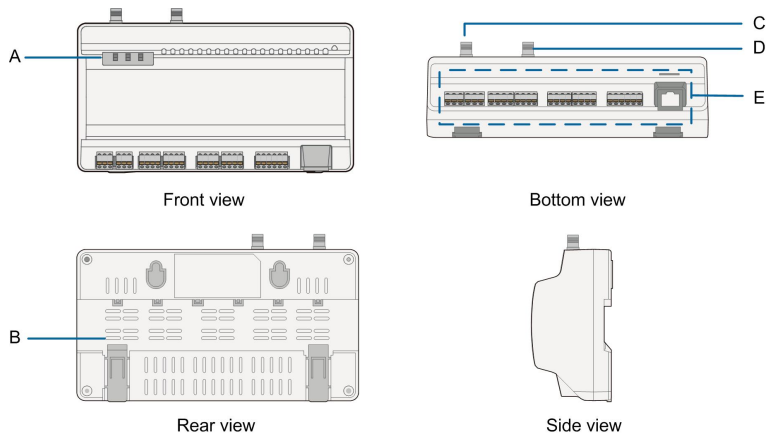

Figure 3-1 Appearance

Item	Designation	Description
A	Indicator	Indicate the running state of the Logger1000
B	Vent	-
C	WLAN antenna mounting hole	-
D*	4G antenna mounting hole	-
E	Wiring terminal	Refer to "Table 7-1 Port description"

Note: D* is 4G antenna mounting hole. The Logger1000A is provided with the hole while the Logger1000B is not. Specifically, refer to the actual product received. In the following, description is given by using the Logger1000A as an example.

Indicator

Indicator (print)	LED color	LED status	Description
Running indicator (RUN)	Red/green	Off	No external power supply connected
		Slow flash (Green)	Normal running
		Slow flash (Red)	Device alarm
		Steady on (Red)	Logger1000 running fault
4G indicator (4G) *	Blue	Off	No data communication
		Steady on	4G connected successfully
		Slow flash	Data communication in process
WLAN indicator (WLAN)	Blue	Off	No data communication
		Steady on	WiFi connected successfully
		Slow flash	Data communication in process

Note: * Only the Logger1000A is equipped with the 4G indicator.

- Slow flash means that the indicator flashes once every second.
- Slow flash of the communication indicator indicates data communication in process. If there has been no data communication with iSolarCloud for 10s, the indicator will keep steady on.

3.3 Dimensions

Figure 3-2 Dimensions

Width (W)	Height (H)	Depth (D)
200mm	110mm	60mm

4 Installation Flow

The following figure shows the overall installation flow of Logger1 000.

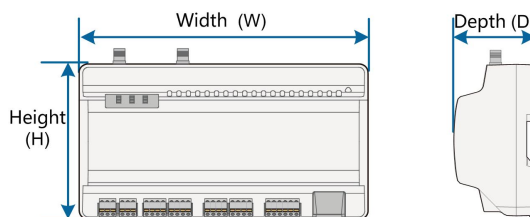
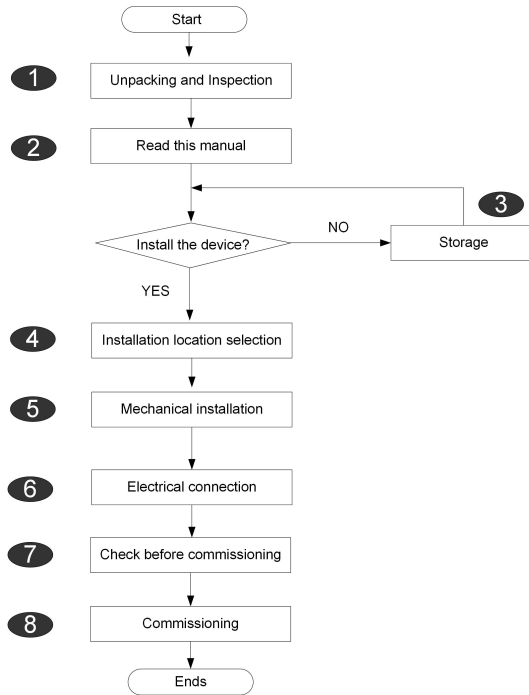

Figure 4-1 Installation Flow

Table 4-1 Description of the installation flow

No.	Procedure	Reference chapter
1	Unpacking and inspection	"5.1 Scope of Delivery"
2	Read this user manual, especially " Safety Instructions "	"2 Safety Instruction"
3	Store the Logger1000 properly if it is not to be installed immediately	"5.4 Storage"
4	Installation location selection	"6.1 Installation Location Selection"
5	Mechanical installation	"6 Mechanical Installation"
6	Electrical connection	"7 Electrical Connection"
7	Check before commissioning	"8.1 Inspection before Commissioning"
8	Commissioning	"8.2 Commissioning Steps"

5 Unpacking and Storage

5.1 Scope of Delivery

Check the scope of delivery for completeness according to the packing list. The following items should be included.

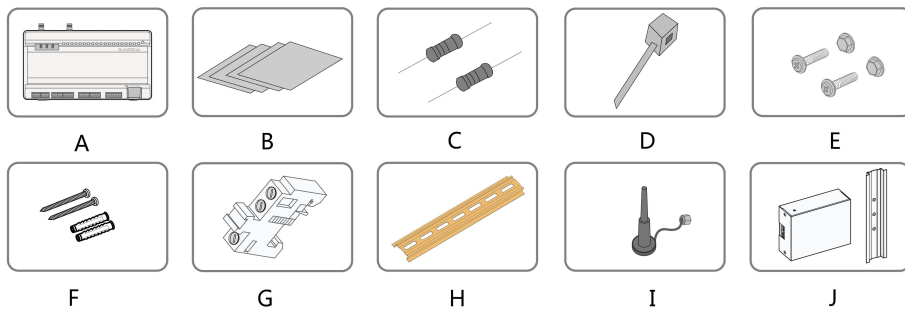

Figure 5-1 Scope of delivery

Item	Designation	Description
A	Logger1000	Logger1000
B	Documents	Quick User Manual, quality certificate, packing list, product test report, and warranty card
C	Communication terminal resistor	6x120Ω (Note: if there are more than 15 devices connected on the RS485 bus, it is recommended to connect a 120Ω terminal resistor in parallel on the A and B lines at the head or tail end of the bus)
D	Nylon cable tie	Used to tie cables
E	Fastener assembly	4 sets, M4X16, used for wall-mounting to fasten the device on the metal surface
F	Expansion bolt	4 sets, ST4.8X19, used for wall-mounting to fasten the device on the concrete wall
G	Terminal fastener	2 sets, E/UK-1201442, fixed on the guide rail to prevent the Logger1000 from moving
H	Guide rail	Length: 240mm

Item	Designation	Description
I	WLAN antenna 4G antenna	The Logger1000A is provided with the 4G antenna mounting hole while Logger1000B is not. Specifically, refer to the actual product received.
J	Power box	Converters the AC current into DC current Length of supporting guide rail: 170mm

5.2 Identifying the Logger1000

The type and key technical parameters of the Logger1000 can be found on the nameplate. The nameplate is attached to the back of the Logger1000, shown by A in the figure below.

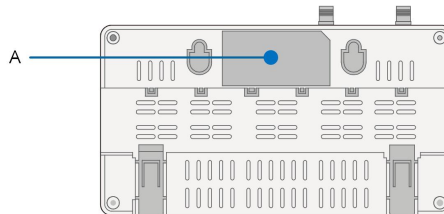

⚠ WARNING

The nameplate contains important parameters. Ensure it is intact and clearly legible.

5.3 Checking upon Receiving

The Logger1000 is thoroughly inspected and packed before delivery, but damage may be still caused during transport. Check the following items carefully once receiving the Logger1000.

- Check the scope of delivery for completeness according to "5.1 Scope of Delivery"
- Ensure that the device type is correct.
- Check the device thoroughly and ensure there are no visible damages.

If there are any problems, contact SUNGROW or the forwarding company.

⚠ WARNING

Only undamaged Logger1000 can be installed and commissioned. Before installation, ensure that:

- The Logger1000 is intact without any damages.
- Related documents, such as quick user manual, are enclosed.

5.4 Storage

If the Logger1000 is not to be installed immediately after receiving, observe the following requirements to store it properly:

- The Logger1000 should be stored in its original packing case and placed in a well-ventilated, dry, and tidy room.
- The storage carrier should be suitable for the weight of the Logger1000.
- The storage environment should be well-ventilated, dry, and without any accumulated water.
- Ambient temperature: -40°C to $+85^{\circ}\text{C}$; relative humidity: 0~95%, no condensation.
- Take precautions to protect the device against damage due to harsh environment such as shock cooling, shock heating, and collision.
- Regularly inspect the Logger1000, usually at least once a week. Check the packing case for intactness and replace it immediately when necessary.
- Unpack and check the Logger1000 in powered on state if it has been stored more than half a year.

WARNING

- **The Logger1000 must be packed during storage!**
- **Never store the Logger1000 outdoors or in an environment directly exposed to sunlight!**
- **No tilting or stacking!**



After long-time storage, thoroughly check the Logger1000 and ensure it is undamaged before installation. If necessary, install the Logger1000 only after it has been tested by qualified personnel.

6 Mechanical Installation

6.1 Installation Location Selection

Selecting an optimal installation location for the Logger1000 is critical to safe operation, long service life, and sound performance.

Take the following requirements into account when selecting the installation location:

- With the ingress of protection IP 20, the Logger1000 can be installed only indoors.
- Ambient temperature range: -30°C to $+60^{\circ}\text{C}$.
- The relative humidity should not exceed 95%. If otherwise, the internal components will be damaged.
- Take anti-moisture and anti-corrosion measures.
- Ensure that enough space is reserved around the Logger1000. The installation location should be 1,500mm above the ground surface, and maintenance clearance of at least 500mm should be reserved. Minimum clearances are shown in the figure below.

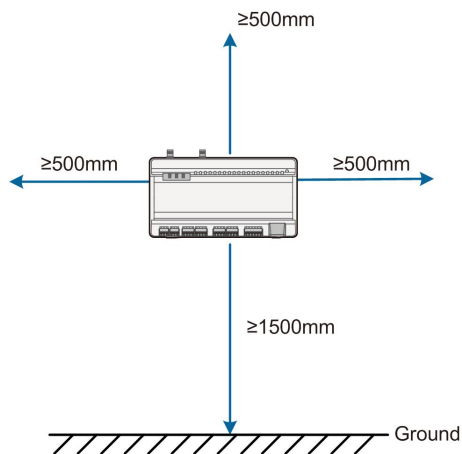

NOTICE

When there are external devices (such as Meteo Station) connected to the Logger1000, users should add corresponding communication SPD according to onsite condition.

6.2 Installation Tools

Installation tools include but are not limited to the following recommended ones. If necessary, use other auxiliary tools on site.



6.3 Installing Logger1000

The Logger1000 can be installed in the wall-mounting manner or guide rail-mounting manner, and users can select either one according to onsite condition.

6.3.1 Wall-Mounted Installation



Mount the Logger1000 onto the concrete wall or metal surface according to onsite conditions.

Mount the Logger1000 onto the wall via the wall-mounting holes (as shown in the figure below) on the back of it.

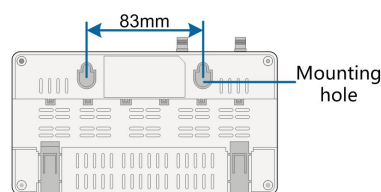
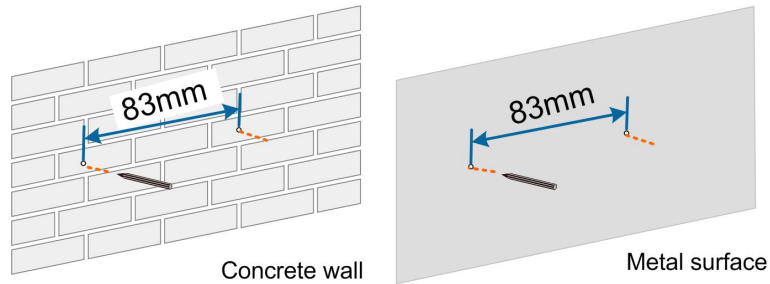

Figure 6-1 Wall-mounting hole dimension

Step 1 Select an appropriate installation surface.

Step 2 Mark positions for drilling holes with a marker.



Step 3 Drill the holes with a drill according to the marked positions.

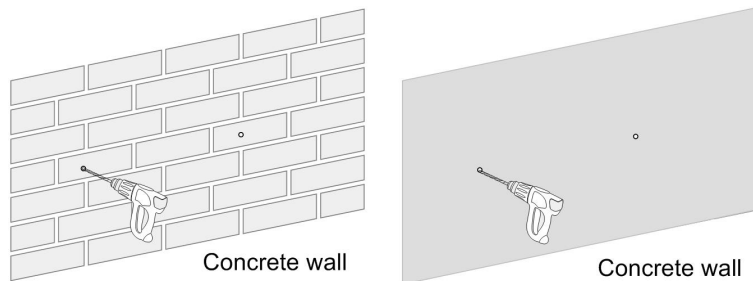

⚠ DANGER

Avoid drilling holes in the utility pipes and/or cables attached to back of the wall!

NOTICE

Operation personnel should wear goggles and dust mask throughout the drilling process to avoid dust inhalation or contact with eyes.

Step 4 Secure the expansion bolts into the holes with a rubber mallet.

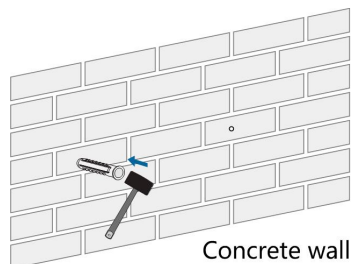

If the Logger1000 is installed onto the metal surface, skip performing this step.

Step 5 Fix the screw or bolt on the installation surface, where the screw protrudes from the wall surface by about 5mm. Hang the Logger1000 onto the screws on the concrete wall or metal surface via the wall-mounting holes on the back of Logger1000.

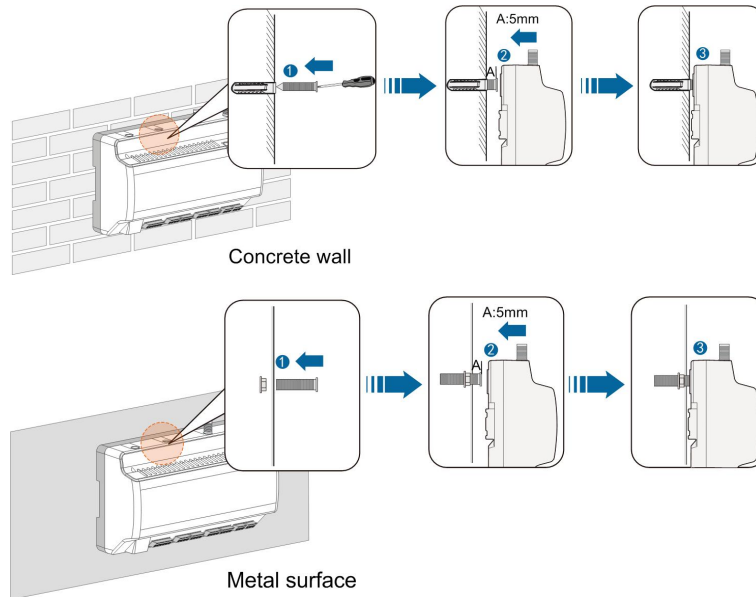

Step 6 Check and ensure that the Logger1000 is firmly installed.

-- End

6.3.2 Guide Rail-Mounted Installation

Secure the Logger1000 via the rail buckles (as shown in the figure below) on the back of it.

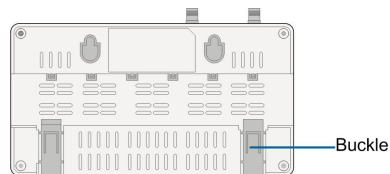

Step 1 Install and secure the guide rail at the appropriate location.

Step 2 Slight press down the recessed part under the buckle of Logger1000 with a flat-head screwdriver or other similar tools to pull out the buckle outwards.

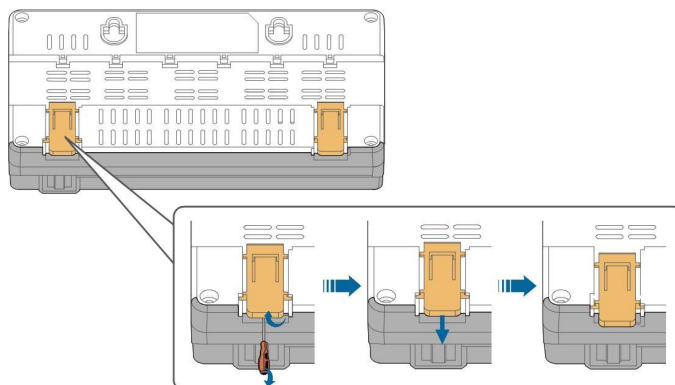

Step 3 Hook the Logger1000 into the guide rail from above and press down the lower part of the Logger1000 until it snaps into place.

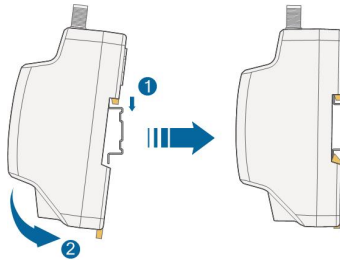

Step 4 Push the buckle of the Logger1000 upwards to clamp the guide rail.

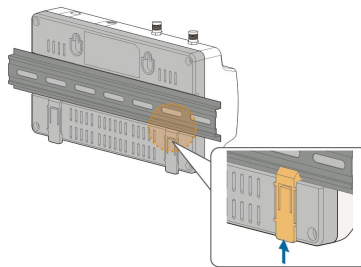

Step 5 Secure the terminal fasteners on both ends of the guide rail, to prevent the Logger1000 from moving.

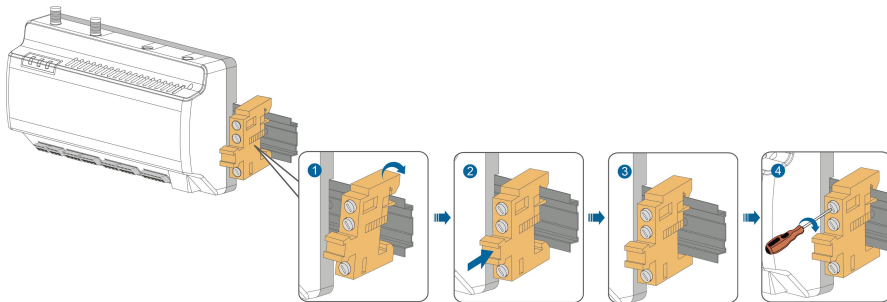

Step 6 Check and ensure that the Logger1000 is firmly installed.

-- End

6.4 Installing Antenna

The sucker antenna base should be placed on a metal surface outside the container to avoid impact on signal reception.

Antenna entry should be reserved on the container, and the entry hole size is 20mm.

Secure the sucker antenna base onto the surface outside the container, lead one end (- with the nut) of the antenna through the drilled hole, and fix it onto the corresponding terminal of the Logger1000 clockwise, as shown in the figure below.

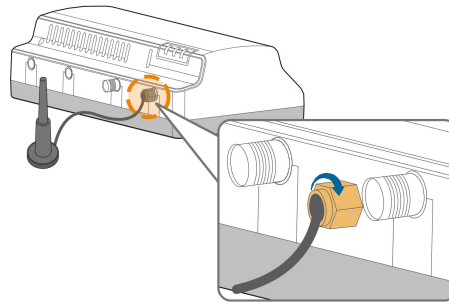

6.5 Installing Power Box



Mount the power box onto the concrete wall or metal surface according to onsite conditions.

Secure the power box via the buckles (as shown in the figure below) on the back of it.

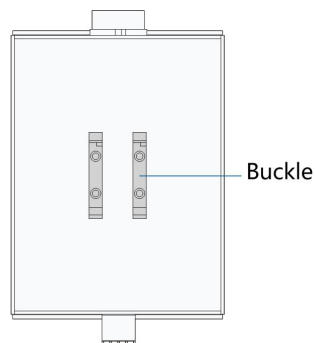

Step 1 Install and secure the power box guide rail at the appropriate location.



The power box should be 200mm away from the Logger1000 to ensure that the power cable from the power box can be connected to the power input port of the Logger1000.

Step 2 Tilt the power box and hook the buckle into the guide rail. Press down the power box until it snaps into place with an audible "Click" sound.

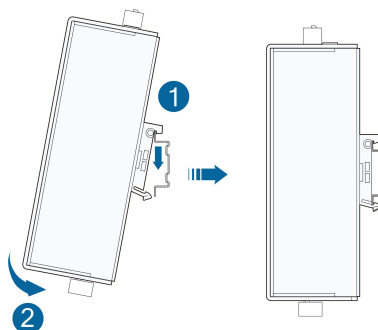

Step 3 The installation of the power box and Logger1000 is completed.

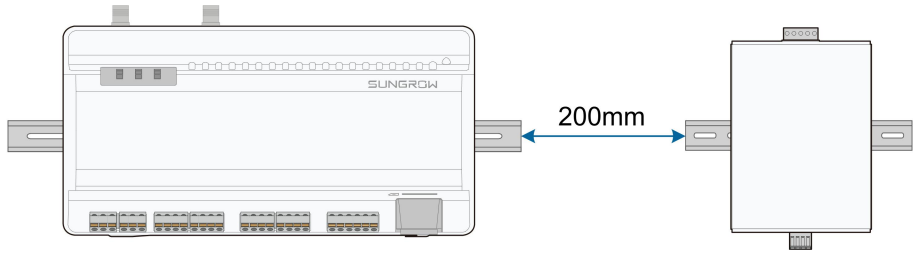

-- End

7 Electrical Connection

7.1 Safety Instructions

NOTICE

Incorrect cable connection may cause device damage or even personal injury.

NOTICE

All cables must be intact, well insulated, appropriately dimensioned, and firmly connected.

7.2 Port Introduction

External wiring terminals are located at the bottom of Logger1000, and the wiring area is shown in the figure below.

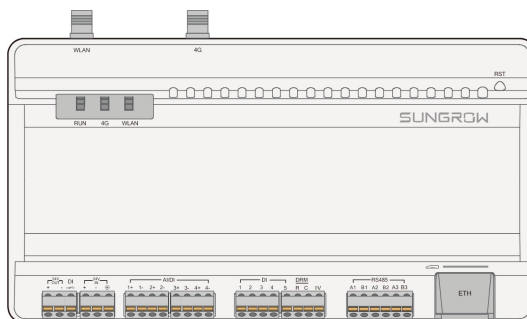



Figure 7-1 Wiring area

Table 7-1 Port description

Port	Function	Description
24V OUT	24V power output	24V ± 5%, the max. output current: 0.5A
DI	Converters AI into DI	Switch for enabling the AI/DI function
24V IN	24V power input	24V ± 3%
	Grounding	Connecting protective grounding cable
AI/DI	Compatible with AI/DI function	Default AI input sampling: 0-10V or 4-20mA
DI	Digital input	Digital signal input

Port	Function	Description
DRM	DRM (Demand Response Modes) function	Works together with the DI1~DI4 to achieve the DRM function
0V	Digital reference point	-
RS485	RS485 communication port	Support of 3 inputs of RS485
 *	SIM card slot	Support of Micro-SIM card
ETH	Ethernet port	Can be connected to background master via devices such as Ethernet switch and router
WLAN	WLAN antenna	-
4G*	4G antenna	-
RST	Restart	Press it for 3s to restart

Note: * Only the Logger1000A is equipped with the SIM card slot and the 4G function.



For the RS485 (A₁B₁~A₃B₃) ports, the communication distance should not exceed 1,000m.

7.3 Connection to PV Devices

Devices in the PV system that can be connected to the Logger1000 include the inverter, Meteo Station, Smart Energy Meter, etc.

7.3.1 Connection to a single inverter

The RS485 port of SUNGROW inverter is RS485 terminal block or RJ45 port.

7.3.1.1 RS485 terminal block connection

Communication cable specification:

Cable	Type	Recommended cross-section
RS485 communication cable	Shielded twisted pair	0.75mm ² ~1.5mm ²

Cable connection procedure:

Step 1 Lead the RS485 communication cable from the inverter to the wiring area of Logger1000.

Step 2 Strip the cable jacket and insulation layer with a wire stripper by about 15mm and 8mm to 10mm respectively.

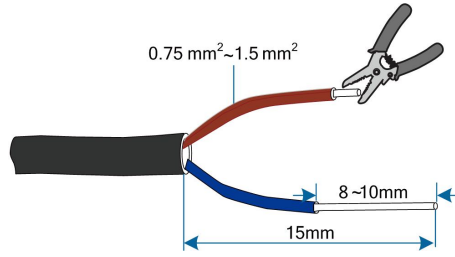

Step 3 Connect the stripped cable to the RS485 ports of the Logger1000, as shown in the figure below.

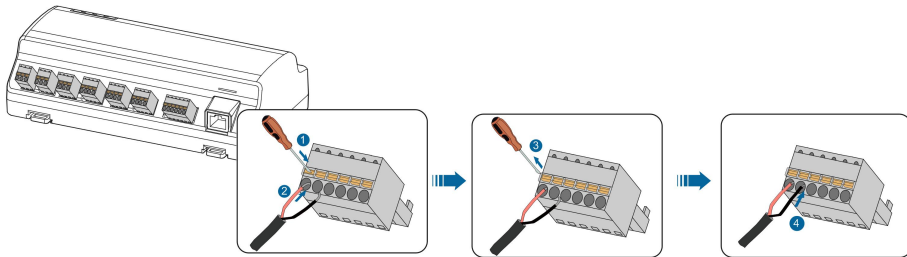

NOTICE

RS485A is connected to port A while RS485B is connected to port B.

NOTICE

The RS485 communication cable must be the shielded twisted pair with the shielding layer single-point grounded.



When a multi-core multi-strand copper wire cable is used, crimp an appropriate euro style terminal at the communication cable head and then connect it to the RS485 port of the Logger1000.

Step 4 Connect the Logger1000 to the inverter.

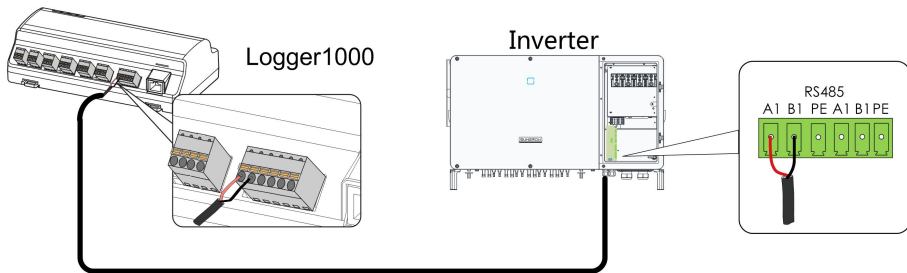

-- End

7.3.1.2 RJ45 port connection

Communication cable specification:

Cable	Type
RS485 communication cable	Shielded twisted pair Ethernet cable

Cable connection procedure:

Step 1 Lead the RS485 communication cable from the inverter to the wiring area of Logger1000.

Step 2 Strip the insulation layer of the communication cable with an Ethernet wire stripper, and lead the corresponding RS485A/B signal cables out. Insert cord end terminals into signal cable RS485+ A and signal cable RS485- B, and crimp them with a crimper. Cut off the redundant signal cable and warp it with a heat-shrink tubing.

If the communication cable is Shielded Ethernet cable, white-green wire 3 is defined as RS485- B wire and the green wire 6 as RS485+ A wire.

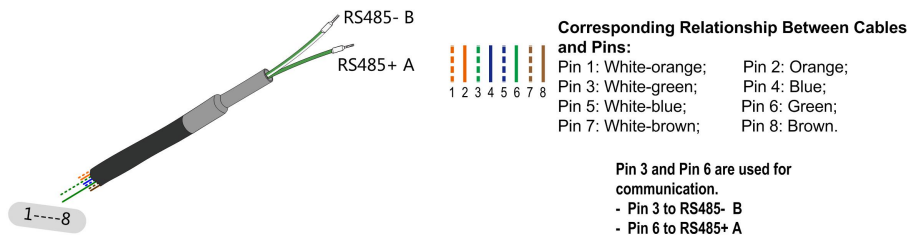

Step 3 Connect the communication cable to the RS485 ports of the Logger1000, as shown in the figure below.

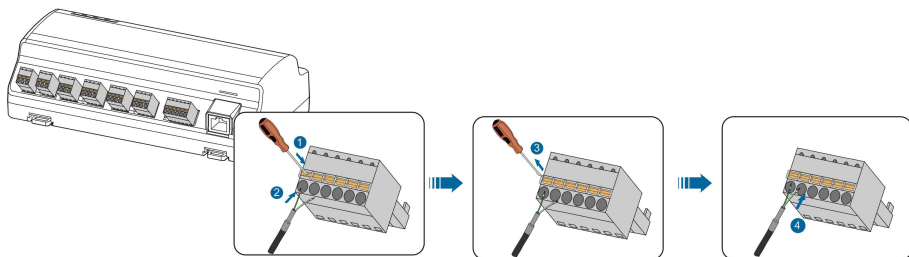

Step 4 Connect the Logger1000 to the inverter.

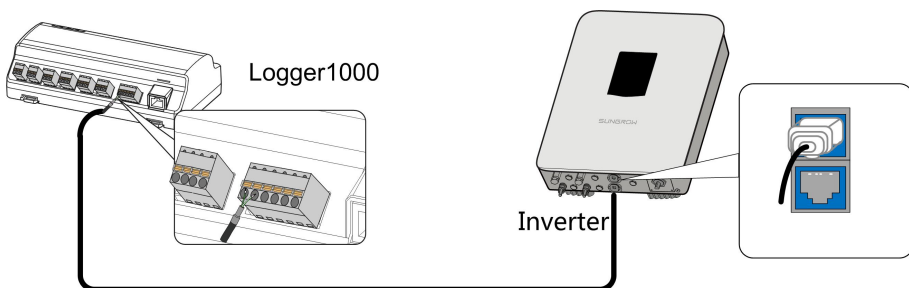

-- End

7.3.2 Connection to multiple devices

Multiple inverters are connected to the Logger1000 in the RS485 daisy chain manner. If more than 15 inverters (14 inverters, for devices other than Logger1000) are connected on the RS485 bus, it is recommended to connect a 120Ω terminal resistor in parallel on the RS485A and RS485B lines at the head and tail end of the bus.

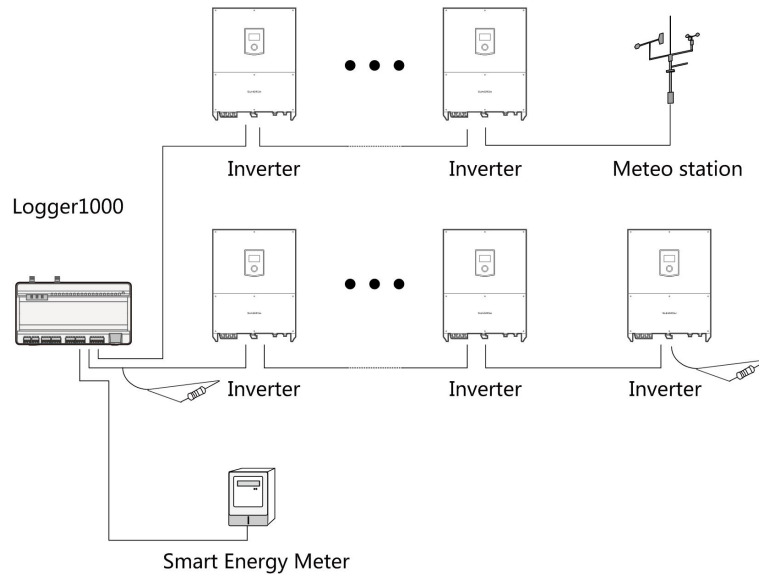

NOTICE

With an outdoor device connected to the Logger1000, it is recommended to connect an SPD to protect the Logger1000 from lightning damage.

- The Logger1000 allows for 3 inputs of RS485 buses and 30 devices at most.
- When the number of device types is less than or equal to the number of RS485 ports of Logger1000, it is recommended to connect different types of devices to different RS485 ports separately.
- The addresses of devices on each RS485 bus must be different from one another and within the address range set for the Logger1000 (address range of residential inverters and string inverters manufactured by SUNGROW: 1-247; address range of third-party devices: 1-255). Otherwise, communication error will occur.
- Serial port parameters of each device on the RS485 bus should be consistent with those of the Logger1000. The serial port parameters include baud rate, data bit, stop bit, and check bit.

7.3.3 Connection to Smart Energy Meter

It is recommended to use the Smart Energy Meter whose communication protocol complies with DL/T645-1997/2007 protocol or Modbus protocol. Logger1000 can be

connected to the Smart Energy Meter through RS485 port or Ethernet port. The recommended Smart Energy Meter types are as follows:

No.	Manufacture	Type	Protocol Type	Wiring
1	Sfere	PD194E/Z		
2	Acrel	PZ96-E3		
3	Acrel	DTSD1352	Modbus RTU	" RS485 Connection"
4	Weidm ü ller	EM 610		
5	SUNGROW	DTSU666		
6	Schneider	IEM3255		" RS485 Connection"
7	Janitza	UMG604 ,	Modbus RTU	" RS485 Connection"
		UMG104	Modbus TCP	" Ethernet Connection"

RS485 Connection

The following figure shows the connection between the Logger1000 and the Smart Energy Meter.

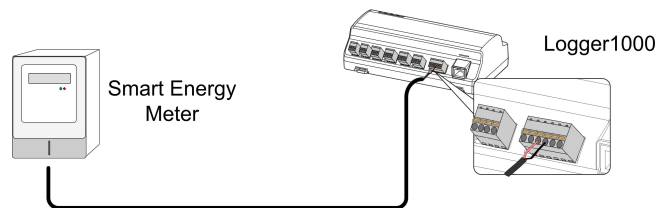

Connect the communication cable led from the Smart Energy Meter to the RS485 port of the Logger1000.



All devices on each RS485 bus support the same communication protocol. If using Weidm ü ller or Janitza meters, it is necessary to connect the RS485 A/B port of the meter to the RS485 B/A port of the Logger1000.

Ethernet Connection

The following figure shows the connection between the Logger1000 and the Smart Energy Meter.

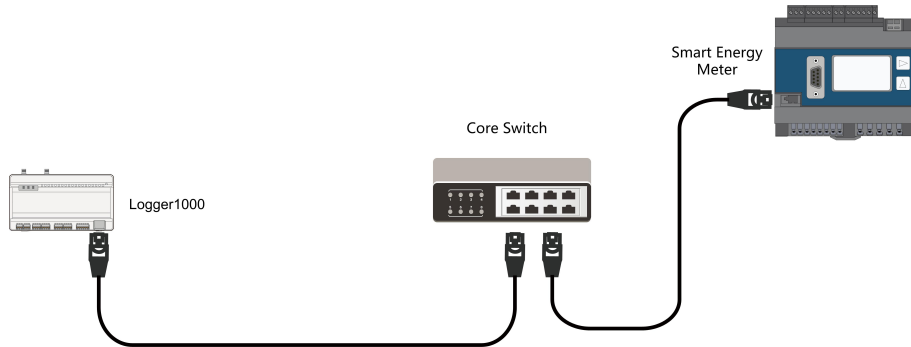

Step 1 Prepare two appropriate Ethernet cables.

Step 2 Connect the cable led from the Smart Energy Meter to a port of the core switch.

Step 3 Connect one end of the other Ethernet cable to another port of the core switch and the other end to the "ETH" port of the Logger1000.



If there is no core switch connected on site, connect the cable led from the Smart Energy Meter directly to the "ETH" port of the Logger1000.

The farthest effective transmission distance of the network cable is 100m, and it is recommended that the actual distance should be no more than 90m. CAT 5E cable or network cable with higher category is recommended.

-- End

7.3.4 Connection to Meteo Station

Meteo Station includes standard Meteo Station and discrete Meteo Station. The discrete Meteo Station consists of several sensors.

It is recommended to use Meteo Station complying with Modbus protocol. Meteo Station can be connected to Logger1000 through RS485 port or AI port. The recommended Meteo Station types are as follows:

No.	Type	Wiring
1	PC-4	
2	PC-4 PRO	
3	WING-TRACKER	
4	WS601	
5	SMP10	"RS485 Connection"
6	RT1	
7	PVMet75	
8	PVMet200	
9	Si-RS485TC	
10	TEMPER_SENSOR	"AI Connection"
11	Meteo sensor	

RS485 Connection

The following figure shows the connection between the Logger1000 and the Meteo Station.

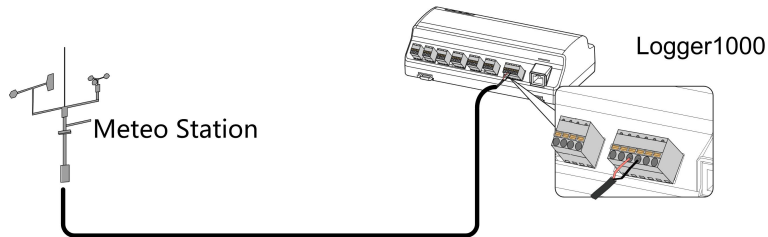

Connect the communication cable led from the Meteo Station to the RS485 port of the Logger1000.



If multiple inverters are connected to the Logger1000 together with the Meteo Station, the Meteo Station should be connected on the very end of the daisy chain.

AI Connection

The following figure shows the connection between the Logger1000 and the Meteo Station.

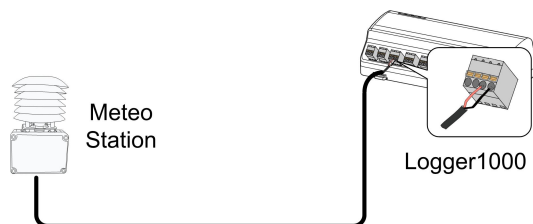

Connect the communication cable led from the Meteo Station to the AI port of the Logger1000.

7.4 Connection to Background

The Logger1000 can be connected to the background of the PV system via the network port, and the communication protocol is standard Modbus TCP or IEC104.

As a slave device, the Logger1000 can be accessed by multiple backgrounds and communicate by using the standard protocol. The following figure shows the connection between the Logger1000 and the background.

The Logger1000 can be connected to multiple monitoring background systems via the Ethernet switch or router, or it may be connected to the single monitoring background system via the network cable.

For example, the Logger1000 is connected to the background system via the Ethernet switch, and the wiring steps are as follows:

Step 1 Prepare an Ethernet cable of suitable length.

Step 2 Insert one end of the cable into the port of the Ethernet switch and the other end to the "ETH" port of the Logger1000.

Step 3 Set IP address of the ETH port to be within the same network segment as that of the background monitoring system.

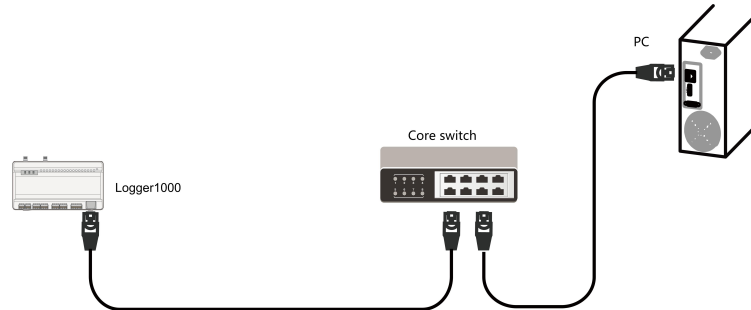

Figure 7-2 Connection to PV background system

NOTICE

Default IP of the "ETH": IP12.12.12.12.

-- End

7.5 Connection to Micro-SIM

Micro-SIM card size: 12mmx15mm.

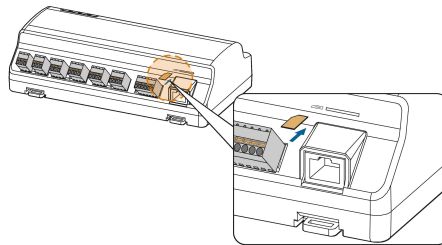

Support of hot plug of Micro-SIM.

7.6 Connection to Power Box

The Logger1000 supports DC24V power supply. Prepare two-core DC cable, three-core AC cable, and grounding cable before wiring. Power cable specifications are shown in the table below.

Table 7-2 Power cable specification

Cable	Recommended cross-section	Length of cable jacket to be stripped off	Length of insulation to be stripped off
DC cable, AC cable	1mm ² ~1.5mm ²	15mm	8mm~10mm
Grounding cable	1mm ² ~1.5mm ²	8mm~10mm	-

Power cable wiring steps are as follows:

Step 1 Strip the cable jackets and insulation layers of the DC cable, AC cable, and grounding cable with a wire stripper by appropriate length.

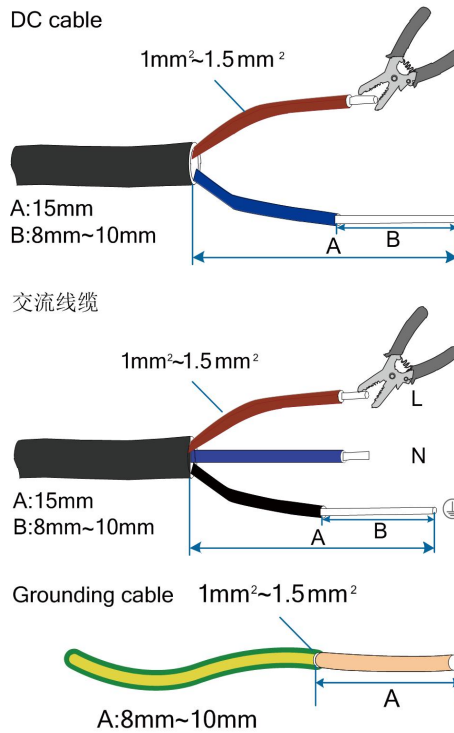

Step 2 Insert the stripped DC cable into the "24V IN" and "24V OUT" ports of the Logger1000. Connect the DC cable led from the "24V OUT" port of the Logger1000 to other devices that need 24V DC power supply.

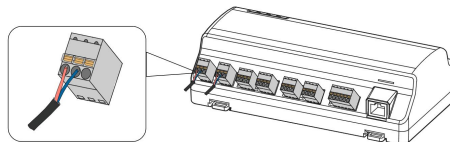

Step 3 Connect the stripped grounding cable to the corresponding port of the Logger1000.

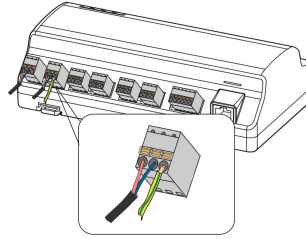

Step 4 Connect the DC cable led from the "24V IN" port of the Logger1000 to the "DC 24V OUT" port of the power box. Connect the stripped AC cable to the "AC (100~277V)" port of the power box, and connect the other end of the AC cable to the 220V AC power.

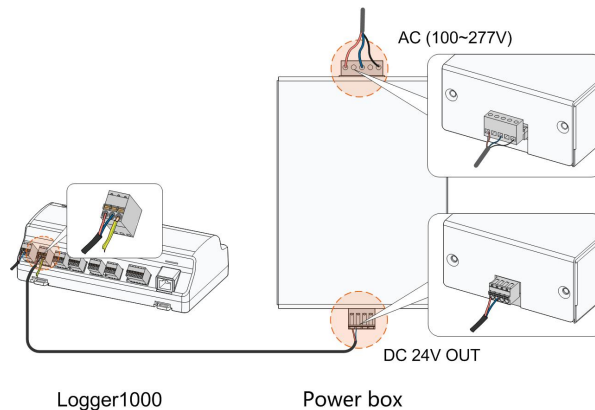

NOTICE

The power source should meet limited power source or PS2 requirements.

-- End

7.7 Cable Routing Requirements

Cables used in the system generally include power cables and communication cables. The communication cable needs to be routed away from the power cable, and the cables need to form a right angle at the intersection. The communication cable needs to be as short as possible and keeps a distance from the power cable. Power cables and communication cables should be routed in different cable trenches to avoid long-distance parallel cable routing of power cables and other cables, thereby reducing electromagnetic interference due to output voltage transient. The distance between the power cable and communication cable should be greater than 200mm. When the cables meet with each other, the cross angle should be 90° , and the distance can be reduced accordingly. The following table shows the recommended minimum distances between parallel shielded communication cables and power cables.

Parallel cable length (m)	Min. distance (m)
200	0.3
300	0.5
500	1.2

The communication cables should be routed as closely to the ground surface or supports (such as support beam, steel channel, or metal rail) as possible.

8 Commissioning

8.1 Inspection before Commissioning

No.	Inspection item	Result
1	All cables are intact, well-insulated, and appropriately dimensioned	<input type="checkbox"/>
2	All cables are connected correctly and firmly	<input type="checkbox"/>
3	The polarity of the power supply cable is correct. The grounding cable is reliably grounded	<input type="checkbox"/>

8.2 Commissioning Steps

No.	Step	Result
1	Inspection before commissioning	<input type="checkbox"/>
2	Power on the Logger1000.	<input type="checkbox"/>
3	Check whether the indicators of Logger1000 normally flash.	<input type="checkbox"/>
4	Connect the debugging PC to the "ETH" port of the Logger1000 via the network cable (default IP address of "ETH": 12.12.12.12). Log in the Web at 12.12.12.12 through the IE, Safari or Chrome browser.	<input type="checkbox"/>
5	Make sure the communication cable connecting the device and the Logger1000 is firmly in place, and connect the DC circuit breaker of the inverter to ensure the inverter is supplied with power.	<input type="checkbox"/>
6	Set serial port parameters by referring to the "9.10.10.1 RS485" chapter, including the baud rate, check bit, data bit, and stop bit. The default setting is 9600bps, 8 data bit, 2 stop bit, and no check bit.	<input type="checkbox"/>

No.	Step	Result
7	Set the devices connected to the Logger1000 through the device management function. If the device connected for the first time is SUNGROW string inverter, use "9.8.1 Device List" function to search the device whose address will be automatically allocated. For devices of other types, connect them to the Logger1000 by referring to "9.8.1 Device List". For the devices of other types, the communication address needs to be preset.	<input type="checkbox"/>
8	Enable the DHCP service of the router, so that the Logger1000 automatically obtains the IP address via the DHCP function.	<input type="checkbox"/>
9	Set the iSolarCloud address if data needs to be uploaded to cloud server. The default iSolarCloud station is "China Station". Users in mainland China access the "China Station", users in Europe access the "Europe Station", and users in other regions access the "International station".	<input type="checkbox"/>
10	Check the data of SUNGROW string inverter for correctness on the real-time information interface.	<input type="checkbox"/>
11	Create new plant via the iSolarCloud App and check the iSolarCloud data for correctness.	<input type="checkbox"/>



The auto search function is available for SUNGROW string inverters whose addresses are automatically allocated.

Devices of other types, such as Smart Energy Meter and transformer, can be connected to Logger1000 via the adding device function.

Addresses of the device connected to the same communication port should be different from each other.

Save the settings after operation, and otherwise the settings will not take effect.

Use the iSolarCloud App to create a new plant. Users can directly scan the QR code on the front label of the Logger1000 or manually input the S/N to add communication equipment. For details, refer to the Quick Guidance of iSolarCloud App. Scan the bottom QR Code to view or obtain the Quick Guidance of iSolarCloud App.



9 Web Interface

9.1 Running Requirements

Item	Parameter
Browser	IE11 or later, Chrome65 or later, and Safari11 or later
Min. resolution	1024*768

9.2 Login Steps



The Web interfaces provided in this document are for reference only, and the actual ones may differ.

Users of different types have different permissions. In the following, description is given by using the O&M permission as an example.

Users can log into the Logger1000 via the Ethernet or WiFi (recommended).

9.2.1 WiFi Login

Step 1 Open the wireless network settings of the PC, search for the wireless network "SG-A1234567890" of the Logger1000, and connect the PC to the wireless network of the Logger1000 (without password).



"SG-A1234567890" is just used as an example. For actual wireless network, refer to the S/N on the label attached to the front side of the Logger1000.

The WiFi hotspot is always turned on, and cannot be turned off.

Step 2 Enter the IP address 11.11.11.1 of the Logger1000 in the PC address bar to enter the general user login interface.

Step 3 Click the button "Login" in the upper right corner, enter the default password "pw1111", and click "Login", to enter the O&M user interface.

-- End

User types include "general user" and "O&M user".

The general user can view basic information, real-time fault, and device monitoring information of the Logger1000.



In addition to all permissions of the general user, the O&M user has the permission to set and modify parameters of the Logger1000 and devices connected to the Logger1000.

In the following, description is given by using the O&M permission as an example.



After login for the first time, it is recommended to change the password as soon as possible. Click "O&M user" -> "Modify password" to change the password.

With the login password forgotten, contact SUNGROW and provide the device S/N as well as system time, to get the password.

9.2.2 Ethernet Login

Step 1 The IP address of the PC connected to the Logger1000 is the same as that of the Logger1000. The IP address is 12.12.12.X. For example, the IP address of the PC can be set to 12.12.12.125, and the subnet mask is 255.255.255.0.



IP of Logger1000 is 12.12.12.12 by default, and subnet mask is 255.255.255.0.

Step 2 Connect the Logger1000 to the PC via the Ethernet.

Step 3 Enter the IP address 12.12.12.12 of the Logger1000 in the PC address bar to enter the general user login interface.

Step 4 Click the button "Login" in the upper right corner, enter the default password "pw1111", and click "Login", to enter the O&M user interface.

-- End



User types include "general user" and "O&M user".

Users of different types have different permissions.

9.3 Web Main Interface

When the "O&M user" logs into the Web for the first time, the "Help" window pops up. Follow the prompts to perform operations such as time synchronization, device connection, and forwarding configuration.

The Web main interface is as follows:

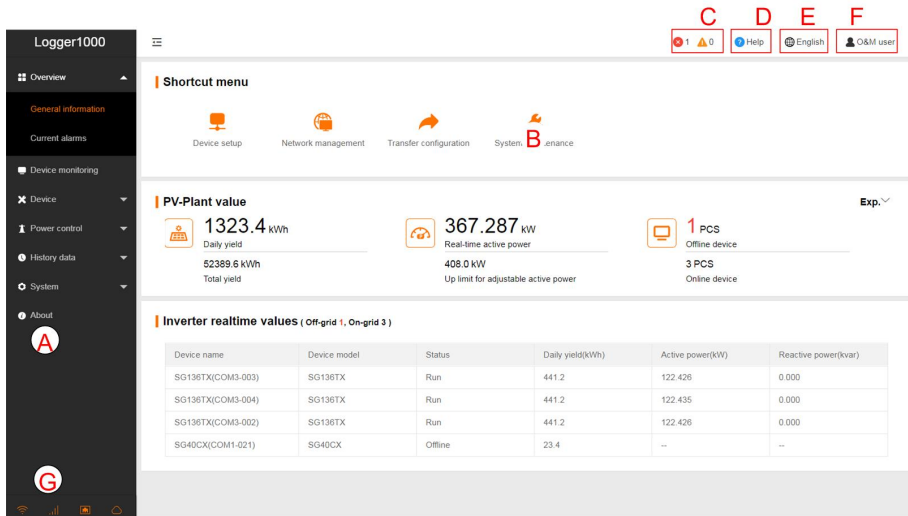

Item	Designation	Description
A	Navigation menu	Display main function modules of the Web
B	Function display area	Display the current interface
C	Alarm icon	Display the current alarm level and alarm number. Users can click the icons to enter the corresponding alarm interface
D	Help	Display the basic configuration steps of the Logger1000
E	Language menu	Click the button to select the desired language
F	User	Display the current login user

G	Information icon		: WiFi connection
			: Wireless connection
			: Ethernet Connection
			: Cloud access

9.4 Web Menu

The Web has seven main function modules: "Overview", "Device Monitoring", "Device", "Power Control", "History Data", "System", and "About".

The permissions of the O&M users are as follows:

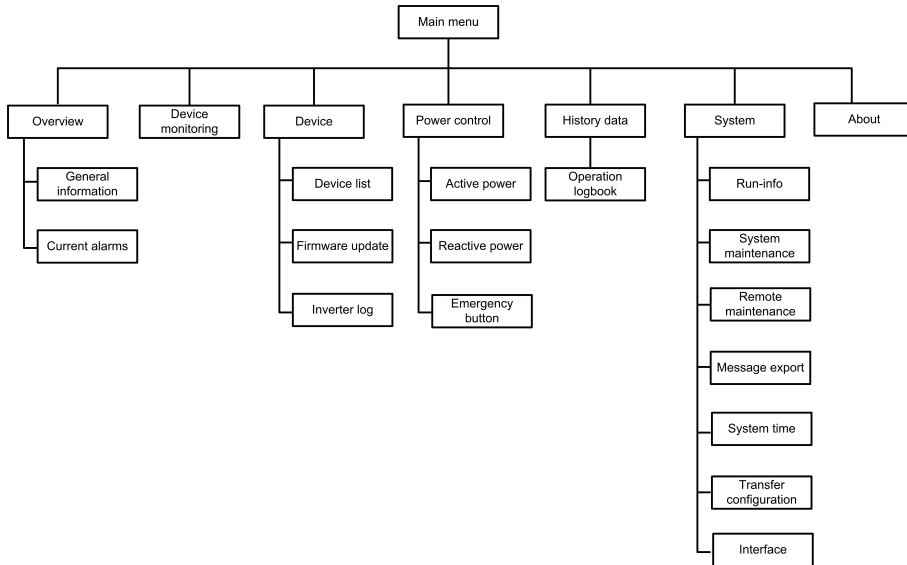

9.5 Operation Procedure

Perform the following operations before logging into the Logger1000 Web for the first time.

Step 1 Complete the electrical connections.

Ensure that the Logger1000 has been correctly connected to other devices. Refer to the chapter ["7 Electrical Connection"](#).

Step 2 Configure serial ports of the Logger1000.

After logging into the Web, first configure the serial ports of the Logger1000, to ensure that the Logger1000 can normally communicate with upstream devices. Refer to the chapter ["9.10.10 Port Parameter"](#).

Step 3 Calibrate the system time.

Check whether the current system time is correct, and perform manual time synchronization or automatic time synchronization when necessary. Refer to the chapter ["9.10.5 System Time"](#).

Step 4 Automatically search the device.

Devices that can be automatically searched, such as SUNGROW string inverter, can be added via the auto search function with addresses allocated automatically. Refer to the chapter ["9.8.1 Device List"](#).

Step 5 Add the device. Refer to the chapter ["9.8.1 Device List"](#).

Step 6 Configure forwarding service.

After all devices have been added, configure the forwarding service of the Logger1000, to ensure that the Logger1000 can forward the data to upstream devices. Refer to the chapter "[9.10.6 iSolarCloud](#)"~"[9.10.9 Third-party portal](#)".

-- End

9.6 Overview

9.6.1 General Information

Click "Overview" -> "General information" to enter the corresponding interface.

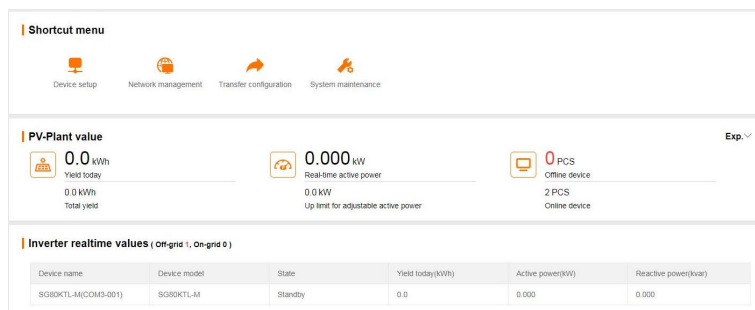

Shortcut menu

Device setup: support of auto search and add device functions. Click the menu to add, delete, modify, and view the device or perform auto search operation to search the device to which address will be automatically allocated. Refer to the chapter "[9.8.1 Device List](#)".

Network management: set Ethernet parameters. Refer to the chapter "[9.10.10 Port Parameter](#)".

Transfer configuration: transfer the data connected by the system to the background. Refer to the chapter "[9.10.6 iSolarCloud](#)"~"[9.10.9 Third-party portal](#)".

System maintenance: support of operations such as system upgrade, log export, and rebooting. Refer to the chapter "[9.10.2 System Maintenance](#)".

PV-plant value

Information such as today yield, total yield, real-time active power, and number of offline devices can be viewed.

Click the button "Exp." to view more information.

Inverter realtime values

Information on the inverter such as state, daily yield, active power, and reactive can be viewed.

9.6.2 Current Alarms

Click "Overview" -> "Current alarms" to view the device fault information.

Information such as device name, alarm name, alarm type, alarm time, fault code, and fault ID can be viewed.

9.7 Device Monitoring

Click "Device Monitoring" to enter the corresponding interface.

Device information such as real-time values, DC data, initial parameter, protection parameter, general parameter, device instruction and device information can be viewed on this interface.

9.7.1 RealTime Values

Realtime information such as power generation, device state, and active power can be viewed on this interface.

Step 1 Click "Device Monitoring" -> "Realtime Values" to view the corresponding information.

Step 2 Click the button “  ” to select the device type.

-- End

9.7.2 DC Data

Click "Device Monitoring" -> "DC data" to view the corresponding information.

On this interface, voltage and current information of multiple inputs of MPPTs and strings can be viewed.

9.7.3 Initial Parameter

Click "Device monitoring" -> "Initial Parameter" to enter the corresponding interface and set initial parameters.

Select the meter, set "PT Transformation Ratio", "CT Transformation Ratio", "Meter Reverse Connection Enable" and "Access Type", click "Save".



When the meter cable is connected reversed, but it is not easy to change the wiring, the correct meter data can be obtained after opening the meter reversing enable switch.

The meter reversal function supports single-phase meters and three-phase meters. Note that only the reverse connection of three phases is supported, and the reverse connection of one or two of the three phases is not supported.

Select the inverter, initial parameters can be set in two manners: single setting and batch setting.

9.7.3.1 Single setting

Step 1 Select the desired country (region) and grid type.

Step 2 Click "Settings" to set initial parameters for the single device.

-- End

9.7.3.2 Batch setting

Step 1 Select the desired country (region) and grid type.

Step 2 Click "Configure Synchronization".

Step 3 Select the desired devices in the pop-up device list, and click "Save" to achieve batch setting.

-- End

9.7.4 Protection Parameter

Click "Device monitoring" -> "Protection Parameters" to enter the corresponding interface and set protection parameters.

Protection parameters can be set in two manners: single setting and batch setting. For specific setting method, refer to "9.7.3 Initial Parameter".

9.7.5 General Parameter

Step 1 Click "Device monitoring" -> "General Parameters" to enter the corresponding interface and set general parameters.

Step 2 Select "Read-back", set register address, register number, and address type, and click the button "Read-back", to read the current value of the device.

Step 3 Select "Settings", set register address, data type, and set value, and click the button "- Save". Parameters can be set for a single device.



For parameters that need to be set, refer to corresponding communication protocol of the inverter.

Step 4 (Optional) Select "Settings", set the "Register Address", "Data Type" and "Set Value", and Click "Configure Synchronization". In the pop-up list of devices, check the devices that need to be set, and click "Save". You can set the parameters for multiple devices.

-- End

9.7.6 Device Instruction

Click "Device Monitoring" -> "Device Instruction" to enter the corresponding interface.

On this interface, users can boot/shutdown the device or reset all settings.

Device instruction can be set in two manners: single setting and batch setting. Take the boot operation as an example for explanation.

9.7.6.1 Single setting

Step 1 Select a device, click "Boot", and a dialog box pops up.

Step 2 Click "Yes" to start a single device.

-- End

9.7.6.2 Batch setting

Step 1 Select a device, click “ Boot ” , and a dialog box pops up.

Step 2 Click "Configure Synchronization".

Step 3 Select the desired devices in the pop-up device list, and click "Save" to achieve batch setting.

Step 4 Click “ Confirm ” on the pop-up dialog box.

-- End

9.7.7 Device Information

Click "Device Monitoring" -> "Device Information" to view the corresponding information. Parameter information such as device S/N, device model, and rated active power can be viewed.

9.8 Device Maintenance

9.8.1 Device List

The function module "Device list" is used for managing devices connected to the Logger1000 and configuring addresses for these devices. Devices can be automatically searched and added.

9.8.1.1 Auto search

The "Auto Search" function is used for SUNGROW string inverter to which addresses will be automatically allocated.

Step 1 Click "Device" -> "Device List" to enter the corresponding interface.

Step 2 Click the button "Auto Search", and the corresponding window pops up. Select an interface type, and click "Search".

Step 3 After that, corresponding devices will be displayed.

-- End



Inverters without the SN do not support the automatic search function and device adding function.

Automatic address allocation pops up only when there is an actual address confrontation.

9.8.1.2 Export

Step 1 Click "Device" -> "Device List" to enter the corresponding interface.

Step 2 Click the button “  ” to export the device list.

-- End

9.8.1.3 Import

Step 1 Click "Device" -> "Device List" to enter the corresponding interface.

Step 2 Click the button “” to export the device list.

Step 3 After the device list is exported, the user can modify device names in batch.

Step 4 After the modification is completed, save the device list file in the .csv format.

Step 5 Click the button “” to import the .csv file into the Web.

-- End

9.8.1.4 Add device

Step 1 Click "Device" -> "Device List" to enter the corresponding interface.

Step 2 Click "Add Device", select a device type in the pop-up window, and fill in the information required.

-- End

9.8.1.5 Add the Third-party Meter (Import Files)

Step 1 Click "Device" -> "Device List" to enter the corresponding interface.

Step 2 Click "Add Device", select “ Meter ” option in the “ Device Type ” .

Step 3 Select the port (COM1/COM2/COM3/NET) that the meter is actually connected to in the “ Port ” .

Step 4 Select “ Others ” option in the “ Device Model ” .

Step 5 Select “ Import Files ” option in the “ Configuration Method ” .

Step 6 Select the corresponding measuring point template in the “ Configuration File ” .Or click the icon “” to import the configuration file.

Step 7 Enter the value of “ Beginning Address ” and the “ Quantity of Device ” , click “ Save ” .



Be aware of the number of device added in each port, the “ Beginning Address ” to be entered should bigger than the device address existed if they are in the same port.

-- End

9.8.1.6 Add the Third-party Meter (Custom)

Step 1 Click "Device" -> "Device List" to enter the corresponding interface.

Step 2 Click "Add Device", select “ Meter ” option in the “ Device Type ” .

Step 3 Select the port (COM1/COM2/COM3/NET) that the meter is actually connected to in the “Port” .

Step 4 Select “Others” option in the “Device Model” .

Step 5 Select “Custom” option in the “Configuration Method” . Click “Next” to enter “Configure Measuring Point” the interface.

Table 9-1 Parameter description

Parameter	Description
Byte Order	Refer to the communication protocol of the meter, parse the order of the read byte stream
PT Transformation Ratio	Refer to the communication protocol of the meter, voltage transformation ratio
CT Transformation Ratio	Refer to the communication protocol of the meter, current transformation ratio
Beginning Address	The beginning address of the device
Quantity of Device	The number of the meter
Debug Address	The device address to be read when click “Read-Back”, the range is [(“Beginning Address”), (“Beginning Address” + “Quantity of Device” -1)]
Modbus Address	Refer to the communication protocol of the meter, the address of Modbus communication protocol, priority to select the register address corresponding to the data type of “Float”
Register Type	Refer to the communication protocol of the meter, the register type of the corresponding measuring point
Data Type	Refer to the communication protocol of the meter, the data type of the corresponding measuring point
Read Type	With or without framing when send messages at this point, recommend to choose continuous type
Coefficient	Refer to the communication protocol of the meter, the coefficient that multiplied the value of the data read
Read-back Value	The value of the selected measuring point read when clicking "Read-back"



The user can select up to 21 objects for setting. Their corresponding parameters such as Modbus address please refer to the user manual of the connected meter.

Step 6 Select the points to be measured, click “Read-back” to read the information from the meter in real time to check the correctness of parameter setting.



Only when the “ Read-back Value ” is consistent with the displayed value of the electric meter, the parameter setting of the measuring point is correct.

Step 7 When the “ Read-back Value ” is consistent with the displayed value of the electric meter, click “ Save Template ” to save the measuring point setting of this/these meter (s) as a template.

Step 8 Enter the template name in the pop-up prompt window and click “ Confirm ” on the prompt window to save the template.



The template name should be a combination of numbers, letters, dashes and underscores starting with English letters, with a maximum length of 32 bits.

Step 9 Click “ Confirm ” on the measuring point configuring window to add the device and save the setting.

-- End

9.8.1.7 Add the Third-party Meteo staion (Import Files)

Step 1 Click "Device" -> "Device List" to enter the corresponding interface.

Step 2 Click "Add Device", select “ Meteo Staion ” option in the “ Device Type ” .

Step 3 Select the port (COM1/COM2/COM3) that the meteo staion is actually connected to in the “ Port ” .

Step 4 Select “ Others ” option in the “ Device Model ” .

Step 5 Select “ Import Files ” option in the “ Configuration Method ” .

Step 6 Select the corresponding measuring point template in the “ Configuration File ” .Or click the icon “  ” to import the configuration file.

Step 7 Enter the value of “ Beginning Address ” and the “ Quantity of Device ” , click “ Save ” .



The Modbus ID addresses of the devices connected in the same COM port of Logger1000 cannot be repeated.

-- End

9.8.1.8 Add the Third-party Meteo staion (Custom)

Step 1 Click "Device" -> "Device List" to enter the corresponding interface.

Step 2 Click "Add Device", select “ Meteo Staion ” option in the “ Device Type ” .

Step 3 Select the port (COM1/COM2/COM3) that the meteo staion is actually connected to in the “ Port ” .

Step 4 Select “ Others ” option in the “ Device Model ” .

Step 5 Select “Custom” option in the “Configuration Method”. Click “Next” to enter “Configure Measuring Point” the interface.

Table 9-2 Parameter description

Parameter	Description
Byte Order	Refer to the device Modbus map, parse the order of the read byte stream
Beginning Address	The beginning address of the device
Quantity of Device	The number of the device
Debug Address	The device address to be read when click “Read-Back”, the range is [(“Beginning Address”), (“Beginning Address” + “Quantity of Device” -1)]
Read Type	With or without framing when send messages at this point, recommend to choose continuous type
Coefficient	Refer to the Modbus map of the device, the coefficient that multiplied the value
Read-back Value	The value of the selected measuring point read when clicking “Read-back”



The user can select up to 13 objects for setting. For the corresponding parameters (such as register address, register type, etc.), please refer to the user manual of the connected meteo station.

Step 6 Select the points to be measured, click “Read-back” to read the information from the meteo station in real-time to check the correctness of parameter setting.

Step 7 After confirming that the read-back data is correct, then click “Confirm”.

Step 8 Enter the template name in the pop-up prompt window and click “Confirm” on the prompt window to save the template.



The template name should be a combination of numbers, letters, dashes and underscores starting with English letters, with a maximum length of 32 bits.

Step 9 Click “Confirm” on the measuring point configuring window to add the device and save the setting.

-- End

9.8.1.9 Edit device

Step 1 Click "Device" -> "Device List" to enter the corresponding interface.

Step 2 Click the button  in the operation bar, to modify the name of the device connected to the Logger1000 and other parameters.

Step 3 Click "Save".

-- End



The "Device Name" is named in the form device model (port number-communication address).

Take SG36KTL-M (COM1-7) as an example. SG36KTL-M is device type, COM1 is the communication port, and 7 is the communication address.

9.8.1.10 Delete device

After a device is deleted on site, the user can delete the device from the device list, to keep device consistency.

Step 1 Click "Device" -> "Device List" to enter the corresponding interface.

Step 2 Select the device to be deleted, click the button "Delete".

Step 3 Click "Confirm" in the pop-up window, to delete the device.

-- End

9.8.2 Firmware Update

The firmware update function is used to upgrade the SUNGROW residential inverter and string inverter.

Step 1 Click "Device" -> "Firmware Update" to enter the corresponding interface.

Step 2 Click the button "Select a Firmware File". Select an upgrading file and import it to the system. Matching inverters will be detected.

Step 3 Select the device to be upgraded, and click "Upgrade".

Step 4 Complete firmware update to view current version, target version, start time, end time and other information.

-- End



The firmware file should be in the ".sgu" format.

Never interrupt the upgrade.

9.8.3 Inverter Log

Step 1 Click "Device" -> "Inverter Log" to enter the corresponding interface.

Step 2 Select the device running information, and click the button  to view the export progress.

Step 3 Click "Save" to store the exported log in the local.

Step 4 Click "Cancel" and then "Confirm" on the pop-up window, to cancel the current operation.

-- End

9.8.4 AFCI Activation

Step 1 Click "Device" -> "AFCI Activation" to enter the corresponding interface.

Step 2 Check the devices that need to self-checking, click "Self-checking" and then "Confirm" on the pop-up window.



The status of the self-checking device must be "Enable". If the self-checking status is "Disabled", you can click "▼" to set the self-checking status to "Enable".

Step 3 The result column shows the self-checking status as "Self-testing", and after 7 ~ 8 seconds, the self-checking result will be displayed as "Self-checking Failure" or "Self-test pass".

Step 4 Click "Clear Fault" to bring up a dialog box showing the status of fault clearing.

-- End

9.9 History Data

Click "History data" -> "Operation Log" to enter the corresponding interface.

On this interface, users can view history information.

9.10 System

9.10.1 Running Information

Click "System" -> "Run Information" to enter the corresponding interface.

Information such as mobile network signal strength, WiFi, AI voltage, DI status can be viewed.

9.10.2 System Maintenance

9.10.2.1 System upgrade

Users can upgrade Logger1000 on the Web interface.

Step 1 Click "System" -> "System Maintenance" to enter the corresponding interface.

Step 2 Click "System Upgrade", select the upgrade file, and export it to the system.

Step 3 Click "Upgrade" on the pop-up version information window. The system enters upgrade state.

-- End



The upgrade file should be in the ".zip" format.

9.10.2.2 Log export

Step 1 Click "System" -> "System Maintenance" to enter the corresponding interface.

Step 2 Click the button "Log Export" to enter the corresponding interface.

Step 3 Select the type of logs to be exported, and click "Confirm".

-- End

9.10.2.3 Rebooting

Step 1 Click "System" -> "System Maintenance" to enter the corresponding interface.

Step 2 Click "Rebooting" to enter the corresponding interface.

Step 3 A warning window will pop up, and click "Confirm" to continue the rebooting operation.

-- End

9.10.2.4 Reset all setting

Step 1 Click "System" -> "System Maintenance" to enter the corresponding interface.

Step 2 Click "Reset All Settings" to enter the corresponding interface.

Step 3 A warning window will pop up, and click "Confirm" to continue the reset all settings operation.

-- End



Restoring the factory settings refers to restoring all modified settings to the factory state and will not clear the data.

9.10.3 Remote Maintenance

Step 1 Click "System" -> "Remote Maintenance" to enter the corresponding interface.

The screenshot shows a web interface for Remote Maintenance. It features two dropdown menus: the first is labeled "Remote Maintenance" and is set to "Enable"; the second is labeled "Server" and is set to "Chinese Server". Below these is an orange "Save" button. At the bottom, a message states "Remote Service Has Been Connected" with the URL <https://rm.isolarcloud.com>.

Table 9-3 Parameter description

Remote maintenance switch state	Description
Disabled	Not allow for remote maintenance on the Logger1000
Enable	Allow for remote maintenance on the Logger1000

Step 2 In case the remote maintenance switch is in the "Enable" state, the remote service address needs to be set.

- Users in mainland China select "Chinese Server",
- Users in Europe select "European Server".
- Users in other regions select the "International Server".



The remote maintenance address will change once the Logger1000 is restart.

Step 3 Click " Save " to enter the "Remote Access" interface.

Step 4 Enter the login password and click " Confirm " .

Step 5 Access information is saved in the following two ways.

- Click " Copy remote access information " , and save the access information locally after successful copying.
- Enter the email address and click " Send " to send the access information to the email address.

Step 6 Enter the access link in the URL field to enter the "Remote Maintenance" interface. Enter the device S/N and password, and click " Login " to perform remote maintenance.

-- End

9.10.4 Message Export

Step 1 Click "System" -> "Message Export" to enter the corresponding interface.

Port
Serial Port

Serial Port
COM1

Duration (Min)
1

Start

Stop

Export

Table 9-4 Parameter description

Parameter	Description	Range
Port	-	Serial port: COM1、COM2、COM3 Network port: ETH, WiFi, 4G
Duration	Export the message recorded during the set time	1 min ~ 10min

Step 2 Set parameters, including interface, serial port, and duration, and click "Start" to start recording message. The recording automatically stops when the set time reaches, or the user may manually click the button "Stop" to stop recording message.

Step 3 Click "Export" to export the message.

-- End

9.10.5 System Time

Click the "System Time" to check whether the current system time is correct, synchronize the system time, and enable/disable "Inverter Timing".

Click "System" -> "System Time" to enter the corresponding interface.

Inverter timing

Current time 2019-04-13 00:16

Clock source
NTP

Time zone
(UTC-07:00) Central Time

Domain
ntp.apl.bz

Time interval (min)
5

Last synchronize time 2019-04-13 00:13

Save

Method of setting system time:

- When the option "Inverter Timing" is selected, SUNGROW inverter time will be synchronized with the time of Logger1000.
- When the clock source is set to "User Define", user can manually set the current system time and time zone in the following two manners:
 - Select "Use PC Time" to synchronize the time of the Logger1000 with the time of the PC.
 - Click the "Time Zone" pull-down-list and select the local time zone. Enter the "Date" and "Time" and click "Save" to manually set the time of the Logger1000.

- When the clock source is set to "NTP", time of all devices can be synchronized. Click the "Time Zone" pull-down-list and select the local time zone. Fill in the domain, set the time interval, and click "Save". In this way, the time of the Logger1000 is synchronized with the time of the server.
- The clock source is set to "IEC104". In this way, the Logger1000 and the background must use the IEC104 communication protocol, and otherwise, this manner is invalid.
- The clock source is set to "iSolarCloud".
- The clock source is set to "MODBUS-TCP".

It is recommended to select "User Define" during debugging.

It is recommended that the top priority should be given to the IEC104 and then the iSolarCloud.

NOTICE

Set the system time when using the Logger1000 for the first time.

9.10.6 iSolarCloud

Step 1 Click "System" -> "Transfer Configuration" to enter the corresponding interface.

Step 2 Click the button  to modify the forwarding configuration information of iSolarCloud.

-- End



The default iSolarCloud station is "iSolarCloud of China". Users in mainland China select "iSolarCloud of China", users in Europe select "iSolarCloud of Europe", and users in other regions select the "iSolarCloud of International".

To ensure that the Logger1000 functions normally, the firewall network needs to open the following access rights.

Parameter	Parameter value
Destination address	• api.isolarcloud.com
	• api.isolarcloud.com.hk
	• api.isolarcloud.eu
Destination port	• TCP : 19999
	• TCP : 8443
	• TCP : 80
	• TCP : 443
	• UDP : 123

9.10.7 IEC104

Configure the IEC104 forwarding service for the Logger1000 on this interface.

- Server Mode

In the server mode, Logger1000 is used as a Server and connected to PC server to implement data transmission and instruction delivery.

Click "System" -> "Transfer Configuration" -> "IEC104" to enter the corresponding interface.



The local port is 2404.

- Client Mode

In the client mode, Logger1000 is used as a Client and connected to PC server to implement data transmission and instruction delivery.

Step 1 Click "System" -> "Transfer Configuration" -> "IEC104" to enter the "Server" tab by default.

Step 2 Click "Client" to enter the corresponding tab.

-- End

9.10.7.1 White list setting

When the option "Enable White List" is not selected, and the default IP address is "0.0.0.0", any background devices with valid IP address can access the Logger1000.

When the option "Enable White List" is selected, and specified IP address is entered, only the device with the specified IP address can access the Logger1000.

9.10.7.2 Generate Point Table

Step 1 Turn on the switch of local port 2404.

Step 2 Click "Generate Point Table", and default IEC104 point table will be automatically imported to configuration file.

-- End

9.10.7.3 Edit IEC104 Forwarding Point Table

Step 1 Click "Export of Configuration Tools" to export the IEC104 forwarding point table.

Step 2 Open the sheet "Introduce" of the IEC104 forwarding point table, where data of five types (telemetry, telesignalling, remote pulse, remote control, and remote regulating) are included.

Table 9-5 Introduce tab parameters

Data Type	Description
YC	Telemetry
YX	Telesignalling
YM	Remote pulse
YK	Remote control
YT	Remote regulating

Step 3 Open the sheet "Cfg Para" of the IEC104 forwarding point table to view and set the addresses of the five types of data. The addresses shown in the following table are default ones and can be modified according to actual situation.

Table 9-6 Cfg Para tab parameters

Data Type	YX	YC	YM	YK	YT
Bngr Addr	1	16385	15221	15271	15000

Step 4 Open the sheets such as inverter, Smart Energy Meter, Meteo Station, and Logger1000, to set corresponding measuring point data.

Data Type	DataID	State	Invert	Coefficient	Unit	Data Name
YC	1	Y	N	1000	W	P
YC	2	Y	N	1000	Var	Q
YX	3	Y	Y	1	NA	On-grid
YX	4	Y	N	1	NA	Off-grid
YM	5	Y	N	1	kWh	E-Daily
YK	6	Y	N	1	NA	Power On / Off
YT	7	Y	N	1	kW	P-Set
YT	8	Y	N	1	Var	Q-Set

Table 9-7 Description of parameter

Parameter	Value	Description
Data Type	-	Data type
Data ID	-	Data type
State*	Y	Data is uploaded to the background via the IEC104 communication protocol
	N	Data is not uploaded to the background
Invert*	Y	Negate, 0 is 1, and 1 is 0, available for telesignalling only
	N	No negate, 0 is 0 and 1 is 1

Parameter	Value	Description
Coefficient*	-	Coefficient, available for telemetry, remote pulse, and remote regulating only
Unit	-	Unit, available for telemetry, remote pulse, and remote regulating only NA indicates no unit
Data Name	-	Data name in multiple languages

Note: * indicates that the parameters should be set according to onsite conditions.

Step 5 Open the sheet "Device List" of the IEC104 forwarding point table to sort the devices.

Table 9-8 Device List tab parameters

No	DeviceType	ComID	CollectID	AccessID	Template Sheet	Reserved YX Addr	Reserved YC Addr	Reserved YM Addr	Reserved YK Addr	Reserved YT Addr
1	Plant	--	--	0	Plant	0	0	0	0	0
2	SG80KTL-M	COM1	1	1	SGINV-Old	0	0	0	0	0
3	SG80KTL-M	COM1	2	2	SGINV-Old	0	0	0	0	0
4	SG50KTL	COM2	1	3	SGINV-Old	0	0	0	0	0
5	SG50KTL	COM2	2	4	SGINV-Old	0	0	0	0	0

Table 9-9 Description of parameter



Parameter	Description
No.	Sort devices, and only support moving the whole line for the device type corresponds one-to-one to its parameters in the same line
Device Type	Device type
Com ID*	Number of COM port to which device connected, corresponding to the port data of the "Device list" on the Web interface
Collect ID*	Collect device Modbus address, corresponding to communication address of the "Device list" on the Web interface
Access ID*	Background access address, corresponding to the forwarding address of the "Device list" on the Web interface
Template Sheet	Keep consistent with the that in the device sheet
Reserved YX Addr	Reserved telesignalling address
Reserved YC Addr	Reserved telemetry address
Reserved YM Addr	Reserved remote pulse address
Reserved YK Addr	Reserved remote control address
Reserved YT Addr	Reserved remote regulating address

Note: Export the excel from the "Device list" interface and copy the data in the exported excel.

-- End

9.10.7.4 Import IEC104 forwarding point table

Step 1 After editing the IEC104 forwarding point table, click "Export" -> "IEC104 CFG", so that a prompt window pops up, and then convert the excel file into xml file. The xml file and the excel file are at the same path.

Step 2 Click the button  on the operation bar, and then click the button  on the pop-up window, to import the xml file.

-- End

9.10.7.5 Add Peer Port Information

Step 1 Configure point table, where reference can be made to "[9.10.7.3 Edit IEC104 Forwarding Point Table](#)".

Step 2 After editing the IEC104 forwarding point table, click "Export" -> "IEC104 CFG" in the menu bar, and the prompt window will pop up. Convert the excel file into .xml file, where the .xml file and the excel file are in the same path.

Step 3 Click "Add", to enter the "Advanced Settings" interface.

Step 4 Enter domain and peer port, and select remote signaling measuring point type, remote signaling time mark, and upload with a change.

Step 5 Click configuration  to import .xml file.

Step 6 Click "Save".

-- End

9.10.8 MODBUS

Configure the MODBUS forwarding service for the Logger1000 on this interface.

9.10.8.1 Server Mode

In the server mode, Logger1000 is used as a Server and connected to PC server through Modbus TCP protocol to implement data transmission and instruction delivery.

Step 1 Click "System" -> "Transfer Configuration" -> "MODBUS" to enter the corresponding interface.

Step 2 For the white list setting, refer to "[9.10.7.1 White list setting](#)".

-- End

9.10.8.2 Client Mode

In the client mode, Logger1000 is used a Client and connected to PC server through Modbus TCP protocol to implement data transmission and instruction delivery.

Step 1 Click "System" -> "Transfer Configuration" -> "MODBUS" to enter the "Server" tab by default.

Step 2 Click "Client" to enter the corresponding tab.

Step 3 Click "Add" to enter the "Advanced Settings" interface.

Step 4 Enter domain and peer port and click "Save".

-- End

9.10.8.3 RTU Mode

In the RTU mode, Logger1000 is connected to PC server through Modbus RTU protocol to implement data transmission and instruction delivery.

Step 1 Click "System" -> "Transfer Configuration" -> "MODBUS" to enter the "Server" tab by default.

Step 2 Click "RTU" to enter the corresponding tab.

Step 3 Select serial port and enter delay time.

Step 4 Click .

-- End

9.10.9 Third-party portal

Configure the third-party cloud forwarding service for the Logger1000 on this interface.

Step 1 Click "System" -> "Transfer Configuration" -> "Third-party Portal" to enter the corresponding interface.

Step 2 Turn on the switch.

Step 3 Click the button  on the operation bar, so that an advanced setting window will pop up.

Step 4 Modify the configuration information and click "Save".



Set the FTP path and name it as "/FTP server directory".

For example, for the name "/SUNGROW", / is the root directory, and SUNGROW is the directory where data is stored on the FTP server.

-- End

9.10.10 Port Parameter

Set ports of the Logger1000 on this interface.

9.10.10.1 RS485

Step 1 Click "System" -> "Port Parameter" -> "RS485" to enter the corresponding interface.

Step 2 Click  to modify baud rate, parity bit, and stop bit.

Step 3 Click "Save" to save the information.

-- End





When the Logger1000 is connected to a device via the serial port, the baud rate, parity bit, and stop bit of the serial port should be the same as those set for the connected device, so as to ensure normal communication between the Logger1000 and the connected device. The baud rate is 9,600bps, stop bit is 1, and there is no parity bit by default.

9.10.10.2 Ethernet

Perform Ethernet settings on this interface.

Step 1 Click "System" -> "Port Parameter" -> "Ethernet" to enter the corresponding interface.

Step 2 If auto IP allocation is “  On ”, it is recommended to obtain the current IP address of the ETH port by connecting the WiFi module and logging into 11.11.11.1.

Step 3 If the parameter "Automatically obtain IP settings (DHCP)" is set to “  Close ” fill in the information such as the IP address, subnet mask, and default gateway, and click the button  to save the operation.

-- End



The default IP address of the ETH port is 12.12.12.12.

If both auto IP allocation and WiFi STA client are enabled, ensure that the Ethernet and the WiFi STA are at different network segment. Otherwise, it is probably that neither of the two networks is available.

9.10.10.3 Mobile network

Perform Mobile network setting on this interface.

Step 1 Click "System" -> "Port Parameter" -> "Mobile Network" to enter the corresponding interface.

Step 2 After modifying the APN, username and password, click  to save the information.

-- End

9.10.10.4 WiFi

Perform WiFi setting on this interface.

WiFi STA client

WiFi STA refers to a case in which the Logger1000 connect to another hotspot or router via the WiFi function.

Click "System" -> "Port Parameter" -> "WiFi" to enter the corresponding interface. Users will enter the client mode by default, and the WiFi switch is closed.

WiFi hotspot

WiFi hotspot mode means that the Logger1000 is used as an hotspot, and the PC or mobile phone can be connected to the Logger1000 via the WiFi function.

Click "System" -> "Port Parameter" -> "WiFi" to enter the corresponding interface. Click "Hotspot" to enter the corresponding interface.

Table 9-10 Description of hotspot parameter

Parameter	Description
SSID	Network name
Security	Null: without password WPA2: hotspot encrypted, password required



Changing of the WiFi hotspot password requires reconnection of the WiFi.

9.10.10.5 AI

Step 1 Click "System" -> "Port Parameter" -> "AI" to enter the corresponding interface.

Step 2 Select an input type, set the lower limit and upper limit, and click the button to save the operation.

Table 9-11 Description of AI parameter

Parameter	Default value	Range
Voltage lower limit (V)	0	0 ~ 10
Voltage upper limit (V)	10	0 ~ 10
Current lower limit (mA)	4	4 ~ 20
Current upper limit (mA)	20	4 ~ 20

-- End

9.10.10.6 DI

Step 1 Click "System" -> "Port Parameter" -> "DI" to enter the corresponding interface.

Step 2 Set the initial status to "NO" or "NC", and click the button to save the operation.

-- End

9.10.11 About

Click "About" to enter the corresponding interface.

Information such as firmware information of the Logger1000 can be viewed.

Users can scan the QR code via the iSolarCloud App to add the Logger1000.

10 Grid Dispatching Function

Only installation personnel with some communication knowledge can perform operations described in this chapter.

10.1 Function Description

The Logger1000 not only serves as a communication management device of single PV array/plant, but also has the power regulation function. Multiple regulation manners can meet different regulation requirements. The Logger1000 can regulate the power output of the SUNGROW inverter, and the regulation mainly includes active power control and reactive power regulation.

The Logger1000 can control device power output according to the local preset instructions. In addition, it can receive regulation instructions via the remote communication (IEC104, MODBUS, and TCP), AI, and dry contact (DI).

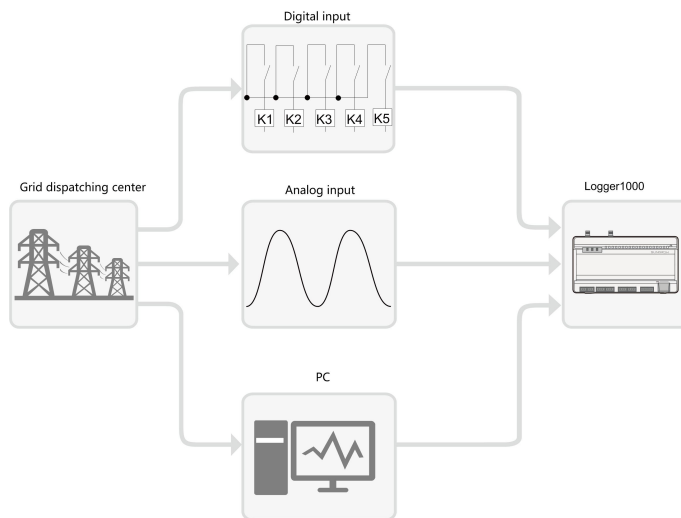

Figure 10-1 Overall frame of power control function

The Logger1000 supports closed-loop power regulation. The regulation accuracy and real-time performance can be further improved by adding an Smart Energy Meter.

The Logger1000 supports fast instruction transfer channels (ms-level processing delay) while ensuring that the dispatching instructions are correctly transmitted to all inverters.

NOTICE

The corresponding power dispatching function is available only when the inverter supports active power control, power factor control, and reactive power regulation!

For details, refer to the inverter user manual or consult the local retailer.

10.2 Interface Description

The Logger1000 is equipped with digital control interfaces and analog control interfaces for receiving digital instructions and analog instructions sent by the grid dispatching center.

10.2.1 Digital Control Interface

The digital control interfaces are at the bottom of the Logger1000, and a sum of 5 digital input ports are provided, as shown in the figure below.

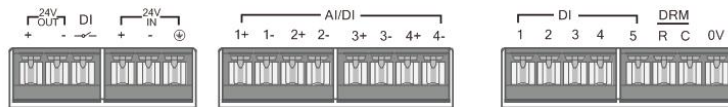
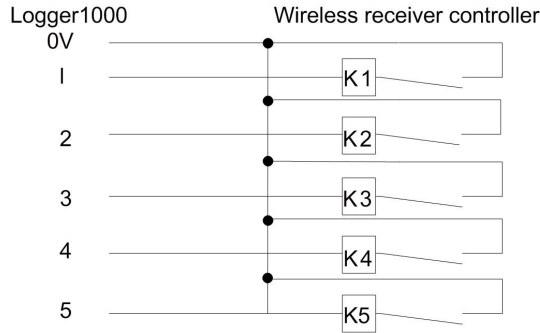

Table 10-1 Digital control interface signal definition

Signal	Definition
DI	Enabling switch for converting AI function to DI function
1+, 1-, 2+, 2- 3+, 3-, 4+, 4-	4 input dry contact channels
1, 2, 3, 4, 5	5 independent-input dry contact signal channel
DRM	Works together with the DI1 to DI4 to achieve the DRM function
0V	Input dry contact signal ground

There are 4 ports at the bottom of the Logger1000 compatible with the AI/DI function. When the DI function of the "AI/DI" port is enabled, use a power cable to connect the "24V OUT+" port to "DI" port.

Wiring between the Logger1000 and the wireless receiver controller is as follows:



In Germany and some other European countries, the grid company uses the Ripple Control Receiver to convert the grid dispatching signal and send it in a dry contact manner. In this case, the plant needs to receive the grid dispatching signal in the dry contact communication manner.

Wiring of the active power dry contact is shown in the figure below:

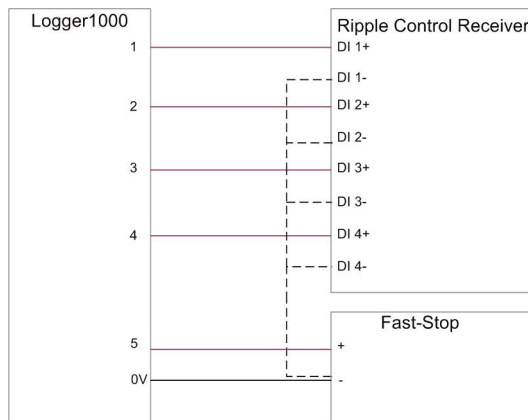

Wiring of the reactive power dry contact is shown in the figure below:

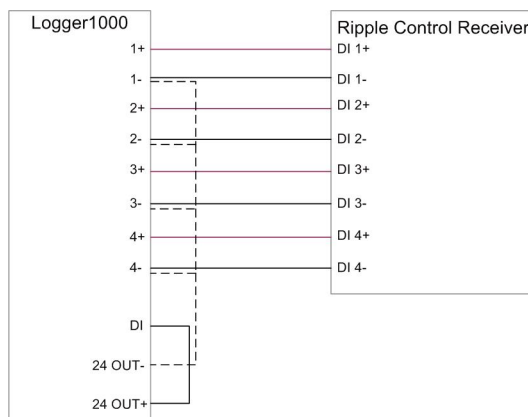

10.2.2 Analog Control Interface

The analog control interfaces are at the bottom of the Logger1000, and a sum of 4 analog input ports are provided, as shown in the figure below.

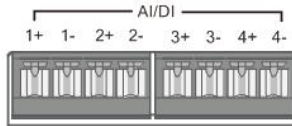

Table 10-2 Analog control interface signal definition

Signal	Definition
1+, 1-, 2+, 2-, 3+, 3-, 4+, 4-	4 analog input channels

The Logger1000 supports 4 inputs of 4 ~ 20mA analog currents or 4 inputs of 0 ~ 10V analog voltage.

10.2.3 DRM Control Interface

The DRM control interface are located at the bottom of the Logger1000, as shown in the figure below.

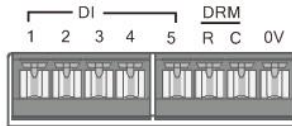

The DRM interface works together with DI1 ~DI4 to achieve the DRM function.

Wiring between the Logger1000 and the DRED is as follows:

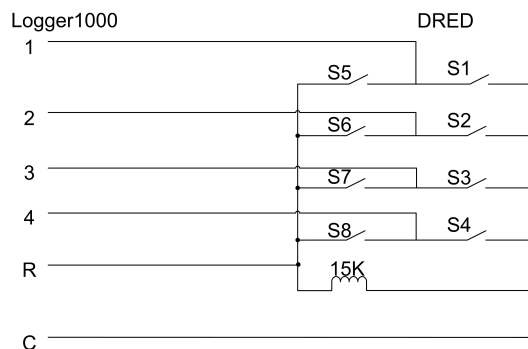

The DRM interface requires that the Logger1000 can be connected to the DRED via the corresponding wiring terminal or RJ45 connector.

10.3 Power Control

Power regulation includes active power control and reactive power regulation.

10.3.1 Active Power

10.3.1.1 Disable

If the inverter needs to operate at full load, the active control mode should be set to "Disable".

Step 1 Click "Power control" -> "Active power" to enter the active power interface.

Step 2 Set the active control mode to "Disable" and click "Save" .

-- End

10.3.1.2 Remote power control

When the instruction source is IEC104 or MODBUS TCP protocol, set the active control mode to "Remote power control".

Step 1 Click "Power control" -> "Active power" to enter the active power interface.

Step 2 Set the active control mode to "Remote power control".

Step 3 Set remote dispatching parameters. For specific parameter description, refer to the following table.

Table 10-3 Parameter description

Parameter	Description
Communication abnormality output (%)	Communication is abnormal, and specified dispatch output value is delivered.
Control method	<p>Open loop control: Remote monitoring background is connected and active instruction of remote dispatching is sent to the power output port of the inverter, thereby achieving active power control.</p> <p>Closed-loop control:</p> <ul style="list-style-type: none"> In case no Smart Energy Meter is selected, remote monitoring background is connected, active instruction of remote dispatching is used as target value, and active power compensation ratio is calculated and sent to the power output port of the inverter. Generally, this strategy is used for fast and accurate active power regulation. In case a Smart Energy Meter is selected, remote monitoring background is connected, active instruction of remote dispatching is used as target value, active power of the meter needs to be collected and used as input parameter, and active power compensation ratio is calculated and sent to the power output port of the inverter. Generally, this strategy is used for anti-backflow or avoiding zero power feed-in.
Select energy meter / transformer*	<p>Unselected</p> <p>Select Smart Energy Meter / transformer involved in power regulation</p>

Parameter	Description
Error limit (%)*	Adjustment accuracy If the ratio of the difference between the active power and the target value to the rated power is within the set error range, the target value is reached.
Adjustment ratio (%)*	If the adjustment does not reach the set target value, increase or decrease adjustment value according to the set adjustment ratio, so as to reach the target value.
Control cycle	Time interval of delivering dispatching instructions Parameter range: 5~60s

Note: *Only when the control method is set to "Closed-loop control", the parameter "-Select energy meter / transformer" is settable.

Step 4 After finishing parameter setting, click "Save" to save the operation.

- - End

10.3.1.3 Local Power Control

If active dispatching instruction or dispatching target value is used as dispatching input locally, the active control mode is set to "Local power control".

Step 1 Click "Power control" -> "Active power" to enter the active power interface.

Step 2 Set the active control mode to "Local power control".

Step 3 Set local dispatching parameters. For specific parameter description, refer to the following table.

Table 10-4 Parameter description

Parameter	Description
Communication abnormality output (%)	Communication is abnormal, and specified dispatch output value is delivered.
Control method	<p>Open loop control : At the start time, the locally configured active instruction is sent to the power output port of the inverter, thereby implementing active power control.</p> <p>Closed-loop control:</p> <ul style="list-style-type: none"> In case no Smart Energy Meter is selected, at the beginning time, the active instruction configured locally is used as target value, and active power compensation ratio is calculated and sent to the power output port of the inverter. Generally, this strategy is used for fast and accurate active power regulation. In case a Smart Energy Meter is selected, at the beginning time, active instruction configured locally is used as target value, active power of the meter needs to be collected and used as input parameter, and active power compensation ratio is calculated and sent to the power output port of the inverter. Generally, this strategy is used for anti-backflow or avoiding zero power feed-in.
Select energy meter*	<p>Unselected</p> <p>Select Smart Energy Meter involved in power regulation</p>
Wiring mode*	<p>Direct connection: One Logger1000 is connected to all inverters, where all the inverters must be string inverters or central inverters.</p> <p>Cascade connection: Multiple Logger1000 are cascaded, and this Logger1000 is used as the host.</p>
Start after communication recovery *	<p>Enable: After the Smart Energy Meter recovers normal communication, the Logger1000 will deliver start instruction to the inverter.</p> <p>Disable: After the Smart Energy Meter recovers normal communication, the Logger1000 will not deliver start instruction to the inverter.</p>

Parameter	Description
Start delay after communication recovery *	After the Smart Energy Meter recovers normal communication, the Logger1000 will deliver start instruction to the inverter. Parameter range: 0~120s
Feed-in stop *	Enable: when feed-in power is detected, theLogger1000 will deliver start instruction to the inverter. Disable: when feed-in power is detected, theLogger1000 will not deliver start instruction to the inverter. Note: Never turn on the Enable switch arbitrarily! Generally, keep it in Disable state.
Control cycle	Time interval of delivering dispatching instructions Parameter range: 5~60s
Q-Method	kW: set active power value %: set active power percentage

Note: *Only when the control method is set to "Closed-loop control", the parameter "Select energy meter" is settable.

Step 4 Add local power control manner

Fill in "Start time" and "Percentage" (fixed value of active power), and click "Save".

-- End

Subsequent Operation

Delete local power control manner: select a local control manner that needs to be deleted, and click "Clear data".

10.3.1.4 AI Control

When using the analog signal at the AI port of the Logger1000 as the dispatching input, set the active control mode to "Analog input".

Step 1 Click "Power control" -> "Active power" to enter the active power interface.

Step 2 Set the active control mode to "Analog input".

Step 3 Set AI control parameters. For specific parameter description, refer to the following table.

Table 10-5 Parameter description

Parameter	Description
Communication abnormality output (%)	Communication is abnormal, and specified dispatch output value is delivered.
Control method	<p>Open loop control: Active instruction controlled by AI is sent to the power output port of the inverter, thereby achieving active power control.</p> <p>Closed-loop control:</p> <ul style="list-style-type: none"> In case no Smart Energy Meter is selected, active instruction controlled by AI is used as target value, and active power compensation ratio is calculated and sent to the power output port of the inverter. Generally, this strategy is used for fast and accurate active power regulation. In case a Smart Energy Meter is selected, active instruction controlled by AI is used as target value, active power of the meter needs to be collected and used as input parameter, and active power compensation ratio is calculated and sent to the power output port of the inverter. Generally, this strategy is used for anti-backflow or avoiding zero power feed-in.
Select energy meter*	<p>Unselected</p> <p>Select Smart Energy Meter involved in power regulation</p>
Control cycle	<p>Time interval of delivering dispatching instructions</p> <p>Parameter range: 5~60s</p>
AI port	AI1 ~ AI4 available
Q-Method	<p>kW: set active power value</p> <p>=: set active power percentage</p>
Min.	Lower limit: 0.0
Max.	<p>When "Q-Method" is set to "%", the upper limit is 100.0%</p> <p>When "Q-Method" is set to "kW", the upper limit is 999999 kW</p>
Step	The minimum difference value between two consecutive power dispatching instructions

Note: *Only when the control method is set to "Closed-loop control", the parameter "- Select energy meter" is settable.

Step 4 After finishing parameter setting, click "Save" to save the operation.

-- End

10.3.1.5 Digital Input

When using the digital signal at the DI port of the Logger1000 as the dispatching input, set the active control mode to "Digital input".

Step 1 Click "Power control" -> "Active power" to enter the active power interface.

Step 2 Set the active control mode to "Digital input".

Step 3 Set DI control parameters. For specific parameter description, refer to the following table.

Table 10-6 Parameter description

Parameter	Description
Communication abnormality output (%)	Communication is abnormal, and specified dispatch output value is delivered.
Control method	<p>Open loop control: Active instruction controlled by DI is sent to the power output port of the inverter, thereby achieving active power control.</p> <p>Closed-loop control:</p> <ul style="list-style-type: none"> In case no Smart Energy Meter is selected, active instruction controlled by DI is used as target value, and active power compensation ratio is calculated and sent to the power output port of the inverter. Generally, this strategy is used for fast and accurate active power regulation. In case a Smart Energy Meter is selected, active instruction controlled by DI is used as target value, active power of the meter needs to be collected and used as input parameter, and active power compensation ratio is calculated and sent to the power output port of the inverter. Generally, this strategy is used for anti-backflow or avoiding zero power feed-in.
Select energy meter*	<p>Unselected</p> <p>Select Smart Energy Meter involved in power regulation</p>
Control cycle	<p>Time interval of delivering dispatching instructions</p> <p>Parameter range: 5~60s</p>
Q-Method	<p>kW: set active power value.</p> <p>%: set active power percentage.</p>

Note: *Only when the control method is set to "Closed-loop control", the parameter "Select energy meter" is settable.

Step 4 Add digital input manner.

Select the desired DI channel, fill in the "Percentage" (fixed value of active power), and click "Save".

-- End

Subsequent Operation

Delete digital input manner: select a digital input manner that needs to be deleted, and click "Clear data".

10.3.1.6 DRM mode

When using the digital signal at the DI port (DI1 ~ DI4) of the Logger1000 as the dispatching input, set the active control mode to "DRM mode".

Step 1 Click "Power control" -> "Active power" to enter the active power interface.

Step 2 Set the active control mode to "DRM mode" and click " Save " .

-- End

10.3.1.7 Country mode

If the dispatching input must be the national power dispatching instruction, the active control mode is set to "Country mode".

Step 1 Click "Power control" -> "Active power" to enter the active power interface.

Step 2 Set the active control mode to "Country mode".

Step 3 Select a country and PPC type, and click "Save".

-- End

10.3.1.8 Scheduling Prohibited

Set the active control mode to "Scheduling prohibited" if the Logger1000 is prohibited to perform active dispatching on the inverter.

Step 1 Click "Power control" -> "Active power" to enter the active power interface.

Step 2 Set the active control mode to "Scheduling prohibited" and click " Save " .

-- End

10.3.2 Reactive Power

10.3.2.1 Disable

If the grid company does not need the power plant to adjust the voltage at the grid-connection point, and the inverter does not need to cooperate with the grid for reactive power compensation, the inverter keeps operating in the reactive-forbidden output state, and the Reactive control mode is set to "Disable".

Step 1 Click "Power control" -> "Reactive power" to enter the reactive power interface.

Step 2 Set the reactive control mode to "Disable" and click " Save " .

-- End

10.3.2.2 Remote Power Control

When the instruction source is IEC104 or MODBUS TCP protocol, set the "Reactive control mode" to "Remote power control".

Step 1 Click "Power control" -> "Reactive power" to enter the reactive power interface.

Step 2 Set the "Reactive control mode" to "Remote power control".

Step 3 Set remote dispatching parameters. For specific parameter description, refer to the following table.

Table 10-7 Parameter description

Parameter	Description
Communication abnormality output (%)	Communication is abnormal, and specified dispatch output value is delivered.
Control method	<p>Open loop control: Remote monitoring background is connected and active instruction of remote dispatching is sent to the power output port of the inverter, thereby achieving active power control.</p> <p>Closed-loop control: Remote monitoring background is connected and reactive instruction of remote dispatching is used as target value, reactive power and power factor of the meter need to be collected and used as input parameters, and reactive power compensation ratio is calculated and sent to power output port of the inverter. Generally, this strategy is used for improving the power factor of the property boundary point.</p>
Select energy meter / transformer*	<p>Unselected</p> <p>Select Smart Energy Meter / transformer involved in power regulation</p>
Error limit (%)*	Adjustment accuracy If the ratio of the difference between the reactive power and the target value to the rated power is within the set error range, the target value is reached.
Adjustment ratio (%)*	If the adjustment does not reach the set target value, increase or decrease adjustment value according to the set adjustment ratio, so as to reach the target value.

Parameter	Description
Reactive power direction*	Forward: The reactive power direction of the inverter array displayed by the meter/transformer is the same as the actual reactive power direction. Backward: The reactive power direction of the inverter array displayed by the meter/transformer is opposite to the actual reactive power direction.
Control cycle	Time interval of delivering dispatching instructions Parameter range: 5~60s

Note: *Only when the control method is set to "Closed-loop control", the parameter "- Select energy meter / transformer" is settable.

Step 4 After finishing parameter setting, click "Save" to save the operation.

-- End

10.3.2.3 Local Power Control

If reactive dispatching instruction or dispatching target value is used as dispatching input locally, the reactive control mode is set to "Local power control".

Step 1 Click "Power control" -> "Reactive power" to enter the reactive power interface.

Step 2 Set the "Reactive control mode" to "Local power control".

Step 3 Set local dispatching parameters. For specific parameter description, refer to the following table.

Table 10-8 Parameter description

Parameter	Description
Communication abnormality output (%)	Communication is abnormal, and specified dispatch output value is delivered.
Control method	Open loop control : At the start time, the locally configured active instruction is sent to the power output port of the inverter, thereby implementing reactive power control. Closed-loop control: At the beginning time, reactive instruction configured locally is used as target value, reactive power and power factor of the meter need to be collected and used as input parameters, and reactive power compensation ratio is calculated and sent to power output port of the inverter. Generally, this strategy is used for improving the power factor of the property boundary point.
Select energy meter*	Select Smart Energy Meter involved in power regulation

Parameter	Description
Wiring mode*	Direct connection: One Logger1000 is connected to all inverters, where all the inverters must be string inverters or central inverters.
	Cascade connection: Multiple Logger1000 are cascaded, and this Logger1000 is used as the host.
Line reactive power compensation*	Compensation for reactive power losses in the line
Control cycle	Time interval of delivering dispatching instructions Parameter range: 5~60s
Q-Method	PF: set the power factor as the target value
	%: set reactive power percentage.

Note: *Only when the control method is set to "Closed-loop control", the parameter "- Select energy meter" is settable. When selecting an energy meter, the Logger used must be the one manufactured by SUNGROW.

Step 4 Add local power control manner

Fill in "Start time" and "Percentage"(PF), and click "Save".

-- End

Subsequent Operation

Delete local power control manner: select a local power control manner that needs to be deleted, and click "Clear data".

10.3.2.4 AI Control

When using the analog signal at the AI port of the Logger1000 as the dispatching input, set the reactive control mode to "Analog input".

Step 1 Click "Power control" -> "Reactive power" to enter the reactive power interface.

Step 2 Set the reactive control mode to "Analog input".

Step 3 Set AI control parameters. For specific parameter description, refer to the following table.

Table 10-9 Parameter description

Parameter	Description
Communication abnormality output (%)	Communication is abnormal, and specified dispatch output value is delivered.
Control method	Open loop control: Reactive instruction controlled by AI is sent to power output port of the inverter, thereby achieving active power control. Closed-loop control: Reactive instruction controlled by AI is used as target value and reactive power and power factor of the meter need to be collected and used as input parameters, and reactive power compensation ratio is calculated and sent to power output port of the inverter. Generally, this strategy is used for improving the power factor of the property boundary point.
Select energy meter*	Select Smart Energy Meter involved in power regulation
Control cycle	Time interval of delivering dispatching instructions Parameter range: 5~60s
AI port	AI1~AI4 available
Q-Method	PF: set the power factor as the target value %: set reactive power percentage
Min. / Max.	When "Q-Method" is set to "%", the parameter ranges from -100.0% to 100.0%. When "Q-Method" is set to "PF", the parameter ranges from -1 to -0.8 or 0.8 to 1.
Step	The minimum difference value between two consecutive power dispatching instructions
Hysteresis range**	When the parameter "Q-Method" is set to PF, dispatching output maintains to be $PF \pm 1$

Note: *Only when the control method is set to "Closed-loop control", the parameter "-Select energy meter" is settable.

** Only when the control method is set to "Open loop control" and the Q-Method to "PF" or when the control method is set to "Closed-loop control", a Smart Energy Meter is selected, and the Q-Method is set to "PF", the parameter "Hysteresis range" is settable.

Step 4 After finishing parameter setting, click "Save" to save the operation.

-- End

10.3.2.5 Digital Input

When using the digital signal at the DI port of the Logger1000 as the dispatching input, set the reactive control mode to "Digital input".

Step 1 Click "Power control" -> "Reactive power" to enter the reactive power interface.

Step 2 Set the reactive control mode to "Digital input".

Step 3 Set DI control parameters. For specific parameter description, refer to the following table.

Table 10-10 Parameter description

Parameter	Description
Communication abnormality output (%)	Communication is abnormal, and specified dispatch output value is delivered.
Control method	Open loop control: Reactive instruction controlled by DI is sent to power output port of the inverter, thereby achieving active power control. Closed-loop control: Reactive instruction controlled by DI is used as target value and reactive power and power factor of the meter need to be collected and used as input parameters, and reactive power compensation ratio is calculated and sent to power output port of the inverter. Generally, this strategy is used for improving the power factor of the property boundary point.
Select energy meter*	Select Smart Energy Meter involved in power regulation
Control cycle	Time interval of delivering dispatching instructions Parameter range: 5~60s
Q-Method	PF: set the power factor as the target value %: set reactive power percentage

Note: *Only when the control method is set to "Closed-loop control", the parameter "Select energy meter" is settable.



The open-loop control has the "PF" Q-Method, and the closed-loop control has the "PF" Q-Method only when the meter is selected.

Step 4 Add digital input manner

Select the desired DI channel, fill in the "Percentage "(PF), and click "Save".

-- End

Subsequent Operation

Delete digital input manner: select a digital input manner that needs to be deleted, and click "Clear data".

10.3.2.6 Country Mode

If the dispatching input must be the national power dispatching instruction, the active control mode is set to "Country mode".

Step 1 Click "Power control" -> "Reactive power" to enter the reactive power interface.

Step 2 Set the reactive control mode to "Country mode".

Step 3 Select a country, PPC type, and instruction type, and click "Save".

-- End

10.3.2.7 Scheduling prohibited

Set the reactive control mode to "Scheduling prohibited" if the Logger1000 is prohibited to perform reactive dispatching on the inverter.

Step 1 Click "Power control" -> "Reactive power" to enter the reactive power interface.

Step 2 Set the reactive control mode to "Scheduling prohibited" and click " Save " .

-- End

10.3.3 Emergency Button

In inverters need to be stopped in batch, select the button "Emergency button".
Click "Power control" -> "Emergency button" to enter the corresponding interface.

Parameter	Description
Emergency button	Enable: The emergency button is turned on, and inverters are stopped in batch. Note:When the emergency button is recovered, and inverters are still in standby mode.It is required to boot the inverters manually via logger or other approaches.
DI port	Associated with DI5 channel

11 Device Maintenance

Due to the effect of ambient temperature, humidity, dust and vibration, the inner components of the Logger1000 will be aging and worn out. To ensure the system safety and maintain the efficiency of the Logger1000, it is necessary to carry out routine and periodic maintenance.

All measures, which can help the Logger1000 to keep good working conditions, are within the maintenance scope.

11.1 Safety Instructions

11.1.1 Safety Rules

⚠ WARNING

Only qualified personnel can perform the work described in this chapter.
Do not leave any screws, washers or other metallic parts inside the Logger1000 to avoid damages to the Logger1000.

⚠ WARNING

Wait at least 5 minutes after the Logger1000 stops and then perform operations on it.

11.1.2 Five Safety Rules

Respect the following five rules thought the maintenance or service process to ensure personnel safety.

- Disconnect the Logger1000 from all the external connections and internal power supplies.
- Ensure that the Logger1000 will not be inadvertently connected.
- Ensure that the Logger1000 is voltage free with a multimeter.
- Connect necessary grounding cables.
- Cover the electrical components with insulation cloth during operation.

11.2 Maintenance

Recommended routine maintenance work is shown in the following table.

Item	Method
Working environment	<ul style="list-style-type: none"> • Check to make sure there is no strong EMC interference device around the Logger1000 • Check to make sure there is no hot source around the Logger1000. • Check to make sure there is no corrosive materials around the Logger1000
Hardware maintenance	<ul style="list-style-type: none"> • Check to make sure the power supply voltage is normal • Check to make sure the cables are connected firmly • Check to make sure the grounding cable is grounded properly
System cleaning	<ul style="list-style-type: none"> • Clean the enclosure, circuit board and the components • Check the heat dissipation hole and the ensure it is not covered
Terminal and cable connection	<ul style="list-style-type: none"> • Check if the screws of the control terminals are loose. Refasten them with screwdriver if necessary; • Check if the connection copper bar or screws are discoloring. • Visually check the wiring layout and the device terminal connection
Software maintenance	<ul style="list-style-type: none"> • Log in Web to check the device communication situation • Log in Web to check the parameter setting of the Logger1000 • Log in Web to check the software version of the Logger1000

11.3 Troubleshooting

WARNING

The grounding cable must be grounded reliably. Otherwise, electric shock can cause personal injury!

The common faults and troubleshooting is shown in the table below. If the problem still cannot be removed by following the instruction in this manual, please contact SUNGROW.

Fault	Cause	Corrective measures
Power-on fault	<ol style="list-style-type: none"> 1. The power supply terminal of the Logger1000 has no power connection 2. Power source failure 3. Logger1000 fault 	<ol style="list-style-type: none"> 1. Connect the power cable to the power supply terminal of the Logger1000 2. Replace the power source 3. Contact SUNGROW
Cannot find any device	<ol style="list-style-type: none"> 1. The RS485 port is not connected to any devices or the connection cable is loose or connected reversely. 2. The RS485 communication parameters are set incorrectly. 3. The devices that do not support automatic search are not manually added, such as Meteo Station and Smart Energy Meter. 4. The address of the manually added device is inconsistent with the actual device address 5. Device does not operate normally. 	<ol style="list-style-type: none"> 1. Check the RS485 communication cable connection; reconnect and tighten the cable if necessary. 2. Check the RS485 communication parameter setting; and make sure the Baud rate and the communication address setting are correct. 3. Manually add the devices such as Meteo Station and Smart Energy Meter. 4. Check the device address setting. 5. Check the device operation status.

Fault	Cause	Corrective measures
The Logger1000 displays the device state as disconnection	<ol style="list-style-type: none"> 1. Communication cable between the device and the Logger1000 is loose or disconnected. 2. The device operates abnormally 3. The device is removed or its configuration is changed 	<ol style="list-style-type: none"> 1. Check the cable connection between the device and Logger1000; and reconnect and tighten the cable if necessary. 2. Power on the device if the device connection is correct 3. Check if there is a device replaced. If so, research or add the device manually. <p>If the device is removed, conduct the “ Device List ” operation through the “ Delete ” .</p>
Cannot communicate with the background	<ol style="list-style-type: none"> 1. The network between the Logger1000 and the background is failed. 2. Network parameter setting is incorrect. 3. The forwarding protocol configuration is incorrect. 	<ol style="list-style-type: none"> 1. Check if the Ethernet port of the Logger1000 is connected to the PC or router correctly. 2. Check if the network parameter is set correctly. 3. Check if the forwarding protocol is set correctly.

12 Appendix

12.1 Technical Data

Communication	
Max. number of devices	30 at most
Communication ports	
RS485 interface	3
Ethernet	1 x RJ45, 10/100/1000Mbps
Digital input	5, Max. 24VDC
Analog input	4, support 4 ~ 20mA or 0 ~ 10VDC
Wireless Communication	
4G Communication	LTE(FDD): B1, B3, B5, B8
	LTE(TDD): B38,B39, B40, B41
	TD-SCDMA: B34, B39
	CDMA: BC0
	GSM: 900/1800 MHz
WiFi communication	WCDMA: B1, B8
	802.11 b/g/n/ac; HT20/40/80MHz; 2.4GHz/5GHz
Power Supply	
DC input	24VDC, max. current: 1.2A
DC output	24VDC, 0.5A
Power consumption	<10W
Ambient Conditions	
Operating temperature	-30°C ~ +60°C
Storage temperature	-40°C ~ +80°C
Relative air humidity	≤95% (no condensation)
Elevation	≤4000m
Protection class	IP20
Mechanical Parameters	
Dimensions (W x H x D)	200 x 110 x 60 mm
Weight	500 g
Mounting type	Top-hat rail mounting/ wall mounting

12.2 Dry Contact Wiring Cable

The wiring cable used for each Logger1000 dry contact needs to meet the requirements in the following table.

Dry contacts	Specification requirements
RS485	Use outdoor UV rated twisted pair with a shielding layer.
	The recommended cable diameter is 0.75~1.5mm ² .
	The maximum wiring distance should be less than 1000m.
AI	The recommended cable diameter is 0.75mm ² .
	The recommended maximum wiring distance is 10m.
DI	The recommended cable diameter is 0.75mm ² .
	The recommended maximum wiring distance is 10m.
Ethernet	Use cat5e or higher specification network cable.
	Communication distance should be less than 100m.
PLC	The recommended cable diameter is 4~10mm ² .
	The maximum wiring distance is 100m.
	Cable withstand voltage to ground must be greater than 1000V

12.3 Quality Assurance

When product faults occur during the warranty period, SUNGROW will provide free service or replace the product with a new one.

Evidence

During the warranty period, the customer shall provide the product purchase invoice and date. In addition, the trademark on the product shall be undamaged and legible. Otherwise, SUNGROW has the right to refuse to honor the quality guarantee.

Conditions

- After replacement, unqualified products shall be processed by SUNGROW.
- The customer shall give SUNGROW a reasonable period to repair the faulty device.

Exclusion of Liability

In the following circumstances, SUNGROW has the right to refuse to honor the quality guarantee:

- The free warranty period for the whole machine/components has expired.
- The device is damaged during transport.
- The device is incorrectly installed, refitted, or used.
- The device operates in harsh environment, as described in this manual.

- The fault or damage is caused by installation, repairs, modification, or disassembly performed by a service provider or personnel not from SUNGROW.
- The fault or damage is caused by the use of non-standard or non-SUNGROW components or software.
- The installation and use range are beyond stipulations of relevant international standards.
- The damage is caused by unexpected natural factors.

For faulty products in any of above cases, if the customer requests maintenance, paid maintenance service may be provided based on the judgment of SUNGROW.

Software licenses

- It is prohibited to use data contained in firmware or software developed by SUNGROW, in part or in full, for commercial purposes by any means.
- It is prohibited to perform reverse engineering, cracking, or any other operations that compromise the original program design of the software developed by SUNGROW.

12.4 Contact Information

Should you have any question about this product, please contact us.

We need the following information to provide you the best assistance:

- Type of the device
- Serial number of the device
- Fault code/name
- Brief description of the problem

China (HQ)

Sungrow Power Supply Co., Ltd

Hefei

+86 551 65327834

service@sungrowpower.com

Australia

Sungrow Australia Group Pty. Ltd.

Sydney

+61 2 9922 1522

service@sungrowpower.com.au

Brazil

Sungrow Do Brasil

Sao Paulo

+55 0800 677 6000

latam.service@sungrowamericas.com

France

Sungrow France

Lyon

+33420102107

service@sungrow-emea.com

Germany, Austria, Switzerland

Sungrow Deutschland GmbH

Munich

+49 0800 4327 9289

service@sungrow-emea.com**Greece**

Service Partner – Survey Digital

+30 2106044212

service@sungrow-emea.com**India**

Sungrow (India) Private Limited

Gurgaon

+91 080 41201350

service@in.sungrowpower.com**Italy**

Sungrow Italy

Verona

+39 0800 974739 (Residential)

+39 045 4752117 (Others)

service@sungrow-emea.com**Japan**

Sungrow Japan K.K.

Tokyo

+ 81 3 6262 9917

service@jp.sungrowpower.com**Korea**

Sungrow Power Korea Limited

Seoul

+82 70 7719 1889

service@kr.sungrowpower.com**Malaysia**

Sungrow SEA

Selangor Darul Ehsan

+60 19 897 3360

service@my.sungrowpower.com**Philippines**

Sungrow Power Supply Co., Ltd

Mandaluyong City

+63 9173022769

service@ph.sungrowpower.com**Thailand**

Sungrow Thailand Co., Ltd.

Bangkok

+66 891246053

service@th.sungrowpower.com**Spain**

Sungrow Ib é rica S.A.U.

Mutilva

+34 948 05 22 04

service@sungrow-emea.com**Romania**

Service Partner - Elerex

+40 241762250

service@sungrow-emea.com**Turkey**

Sungrow Deutschland GmbH Turkey

Istanbul

+90 216 663 61 80

service@sungrow-emea.com**UK**

Sungrow Power UK Ltd.

Milton Keynes

+44 (0) 01908 414127

service@sungrow-emea.com**U.S.A, Mexico**

Sungrow USA Corporation

Phoenix

+1 833 747 6937

techsupport@sungrow-na.com

Vietnam

Sungrow Vietnam

Hanoi

+84 918 402 140

service@vn.sungrowpower.com

**Belgium, Netherlands and
Luxembourg (Benelus)**

Service (only NL): +31 08000227012

service@sungrow-emea.com

Poland

+48 221530484

-

service@sungrow-emea.com

Clean power for all

SUNGROW

Sungrow Power Supply Co., Ltd.

Add: No.1699 Xiyou Rd.,New & High Technology Industrial Development Zone, 230088,Hefei, P. R. China.

Web: www.sungrowpower.com

E-mail: info@sungrow.cn

Tel: +86 551 6532 7834 / 6532 7845

Specifications are subject to changes without advance notice.