

PV Grid-connected Inverter  
User Manual

**SG5KTL-MT / SG6KTL-MT / SG8KTL-M  
SG10KTL-M / SG12KTL-M**





# All Rights Reserved

## All Rights Reserved

No part of this document can be reproduced in any form or by any means without the prior written permission of Sungrow Power Supply Co., Ltd.(hereinafter "SUNGROW").

## Trademarks

**SUNGROW** and other Sungrow trademarks used in this manual are owned by Sungrow Power Supply Co., Ltd.

All other trademarks or registered trademarks mentioned in this document are owned by their respective owners.

## Software Licenses

- It is prohibited to use data contained in firmware or software developed by SUNGROW, in part or in full, for commercial purposes by any means.
- It is prohibited to perform reverse engineering, cracking, or any other operations that compromise the original program design of the software developed by SUNGROW.

Sungrow Power Supply Co., Ltd.

Address: **No.1699 Xiyou Rd., New & High Tech Zone, Hefei, 230088, China.**

Tel: +86 551 6532 7834

Website: [www.sungrowpower.com](http://www.sungrowpower.com)

# About This Manual

The manual mainly describes the product information, guidelines for installation, operation and maintenance. The manual cannot include complete information about the photovoltaic (PV) system. The reader can get additional information about other devices at [www.sungrowpower.com](http://www.sungrowpower.com) or on the webpage of the respective component manufacturer.

## Validity

This manual is valid for the following inverter models:

- SG5KTL-MT
- SG6KTL-MT
- SG8KTL-M
- SG10KTL-M
- SG12KTL-M

They will be referred to as “ inverter ” hereinafter unless otherwise specified.

## Target Group

This manual is intended for:

- qualified personnel who are responsible for the installation and commissioning of the inverter; and
- inverter owners who will have the ability to interact with the inverter.



## How to Use This Manual

Read the manual and other related documents before performing any operation on the inverter. Documents must be stored carefully and be available at all times.

Contents may be periodically updated or revised due to product development. The information in this manual is subject to change without notice. The latest manual can be acquired at <http://support.sungrowpower.com/>.

## Symbols

Safety instructions will be highlighted with the following symbols.

Symbol	Explanation
	Indicates a hazard with a high level of risk that, if not avoided, will result in death or serious injury.
	Indicates a hazard with a medium level of risk that, if not avoided, could result in death or serious injury.
	Indicates a hazard with a low level of risk that, if not avoided, could result in minor or moderate injury.

Symbol	Explanation
<b>NOTICE</b>	Indicates a situation that, if not avoided, could result in equipment or property damage.
	Indicates additional information, emphasized contents or tips that may be helpful, e.g. to help you solve problems or save time.



# Contents

---

All Rights Reserved .....	I
About This Manual .....	II
<b>1 Safety</b> .....	1
1.1 PV Panels.....	1
1.2 Utility Grid .....	1
1.3 Inverter .....	2
1.4 Skills of Qualified Personnel.....	3
<b>2 Product Description</b> .....	4
2.1 Intended Use.....	4
2.2 Product Introduction.....	5
2.2.1 Model Description.....	5
2.2.2 Appearance.....	6
2.2.3 Dimensions .....	7
2.2.4 LED Indicator Panel .....	7
2.2.5 DC Switch.....	8
2.3 Circuit Diagram .....	9
2.4 Function Description .....	9
<b>3 Unpacking and Storage</b> .....	12
3.1 Unpacking and Inspection .....	12
3.2 Identifying the Inverter.....	12
3.3 Scope of Delivery .....	14
3.4 Inverter Storage .....	15
<b>4 Mechanical Mounting</b> .....	16
4.1 Safety during Mounting .....	16
4.2 Location Requirements .....	16
4.2.1 Installation Environment Requirements .....	16
4.2.2 Carrier Requirements.....	17
4.2.3 Installation Angle Requirements .....	17
4.2.4 Installation Clearance Requirements .....	18
4.3 Installation Tools.....	19
4.4 Moving the Inverter .....	20

4.5	Installing the Inverter .....	20
4.6	Connecting the Communication Module (Optional) .....	21
<b>5</b>	<b>Electrical Connection .....</b>	<b>22</b>
5.1	Safety Instructions.....	22
5.2	Terminal Description.....	22
5.3	Additional Grounding Connection .....	23
5.3.1	Additional Grounding Requirements.....	23
5.3.2	Connection Procedure .....	24
5.4	AC Cable Connection .....	25
5.4.1	AC Side Requirements .....	25
5.4.2	Assembling the AC Connector .....	26
5.4.3	Installing the AC Connector .....	28
5.5	DC Cable Connection .....	29
5.5.1	PV Input Configuration .....	29
5.5.2	DC Side Requirements.....	30
5.5.3	Assembling the PV Connector.....	31
5.5.4	Installing the PV Connector .....	32
5.6	RS485 Communication System.....	33
5.7	GPRS Communication System (Optional) .....	35
5.8	Ethernet Communication System (Optional) .....	36
5.9	Smart Energy Meter Connection (Optional).....	36
5.9.1	On the Smart Energy Meter Side.....	36
5.9.2	On the Inverter Side .....	37
<b>6</b>	<b>Commissioning .....</b>	<b>38</b>
6.1	Inspection before Commissioning.....	38
6.2	Commissioning Procedure .....	38
<b>7</b>	<b>iSolarCloud App .....</b>	<b>39</b>
7.1	Brief Introduction.....	39
7.2	Download and Install .....	39
7.3	Login.....	40
7.3.1	Requirements .....	40
7.3.2	Login Steps .....	40
7.4	Function Overview .....	41
7.5	Home.....	42
7.6	Chart.....	43
7.7	More .....	44



7.7.1 Operation Parameters.....	45
7.7.2 Protection Parameter.....	49
7.7.3 Firmware Update.....	50
7.7.4 Feed-in Limitation (Optional).....	51
<b>8 System Decommissioning .....</b>	<b>53</b>
8.1 Disconnecting the Inverter.....	53
8.2 Dismantling the Inverter.....	54
8.3 Disposal of the Inverter.....	54
<b>9 Troubleshooting and Maintenance .....</b>	<b>55</b>
9.1 Troubleshooting .....	55
9.2 Maintenance .....	62
<b>10 Appendix .....</b>	<b>64</b>
10.1 Technical Data .....	64
10.2 Quality Assurance .....	68
10.3 Contact Information .....	69



# 1 Safety

The inverter has been designed and tested strictly according to international safety regulations. Read all safety instructions carefully prior to any work and observe them at all times when working on or with the inverter.

Incorrect operation or work may cause:

- injury or death to the operator or a third party;
- damage to the inverter and other properties.

All detailed work-related safety warnings and notes will be specified at critical points in corresponding chapters.



- The safety instructions in this manual cannot cover all the precautions that should be followed. Perform operations considering actual onsite conditions.
- SUNGROW shall not be held liable for any damage caused by violation of the safety instructions in this manual.

## 1.1 PV Panels

### DANGER

PV strings will produce electrical power when exposed to sunlight and can cause a lethal voltage and an electric shock.

- Always keep in mind that the inverter is dual power supplied. Electrical operators must wear proper personal protective equipment: helmet, insulated footwear, gloves, etc.
- Before touching the DC cables, operator must use a measuring device to ensure that the cable is voltage-free.
- The operator must follow all warnings on the PV strings and in its manual.

## 1.2 Utility Grid

Follow the regulations related to the utility grid.

**NOTICE**

All electrical connections must be in accordance with local and national standards.

Only with the permission of the local utility grid company, the inverter can be connected to the utility grid.

## 1.3 Inverter

**⚠ DANGER**

Danger to life from electric shocks due to live voltage.

- Do not open the enclosure at any time. Unauthorized opening will void warranty and warranty claims and in most cases terminate the operating license.

**⚠ WARNING**

Risk of inverter damage or personal injury.

- Do not disconnect the PV connectors when the inverter is running.
- Wait at least 10 minutes for the internal capacitors to discharge. Ensure that there is no voltage or current before disconnecting any connectors.

**⚠ WARNING**

All safety instructions, warning labels, and nameplate on the inverter:

- Must be clearly legible.
- Should not be removed or covered.

**⚠ CAUTION**

Risk of burns due to hot components!

Do not touch any hot parts (such as the heat sink) during operation. Only the DC switch can safely be touched at any time.

**NOTICE**

Only qualified personnel can perform the country setting. Unauthorized alteration may cause:





- A breach of the type-certificate marking.

Risk of inverter damage due to electrostatic discharge (ESD) !

By touching the electronic components, you may damage the inverter. For inverter handling, be sure to:

- avoid any unnecessary touching;
- wear a grounding wristband before touching any connectors.

**Warning Label**

Label	Description
	Disconnect the inverter from all the external power sources before maintenance!
	Do not touch live parts for 10 minutes after disconnection from the power sources.
	Burn danger due to hot surface that may exceed 60 °C.
	Danger to life due to high voltages! Only qualified personnel can open and maintain the inverter.
	Read the user manual before maintenance!

**1.4 Skills of Qualified Personnel**

All installations must be performed by qualified personnel who should have:

- Training for installation and commissioning of electrical system, as well as dealing with hazards
- Knowledge of the manual and other related documents
- Knowledge of the local regulations and directives

## 2 Product Description

### 2.1 Intended Use

SG5KTL-MT/SG6KTL-MT/SG8KTL-M/SG10KTL-M/SG12KTL-M; a transformerless 3-phase PV grid-connected inverter, is an integral component in the PV power system. The inverter is designed to convert the direct current power generated from the PV modules into grid-compatible AC current and feeds the AC current to the utility grid. The intended usage of the inverter is illustrated in "Figure 2-1 Inverter application in PV power system".

#### **⚠ WARNING**

Inverter cannot connect the PV strings whose positive and negative terminals need to be grounded.

Do not connect any local load between the inverter and the AC circuit breaker. Inverter is applicable only to the grid-connected PV system. Any other usage is strictly forbidden.

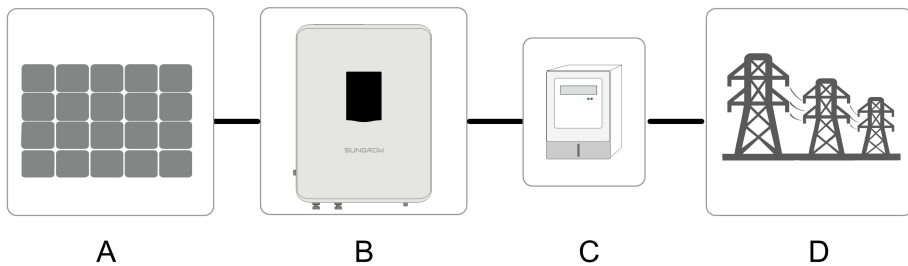
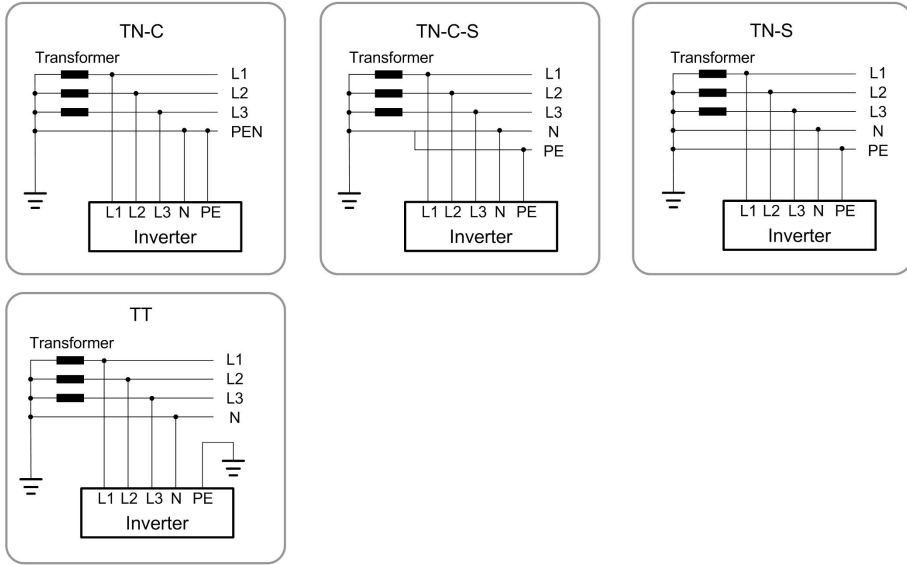

Figure 2-1 Inverter application in PV power system

Item	Description	Note
A	PV strings	Monocrystalline silicon, polycrystalline silicon, and thin-film without grounding
B	Inverter	SG5KTL-MT/SG6KTL-MT/SG8KTL-M/SG10KTL-M/SG12KTL-M
C	Metering device	Meter cupboard with power distribution system
D	Utility grid	TN-C, TN-C-S, TT, TN-S

The following figure shows the common grid configurations.



## 2.2 Product Introduction

### 2.2.1 Model Description

The model description is as follows (Take SG5KTL-MT as an example):

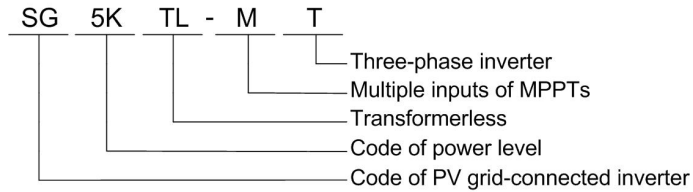

Table 2-1 Power level description

Model	Nominal OutputPower	Nominal Grid Voltage
SG5KTL-MT	5000W	
SG6KTL-MT	6000W	
SG8KTL-M	8000W	3 / N / PE, 230 / 400 V
SG10KTL-M	10000W	
SG12KTL-M	12000W	

## 2.2.2 Appearance

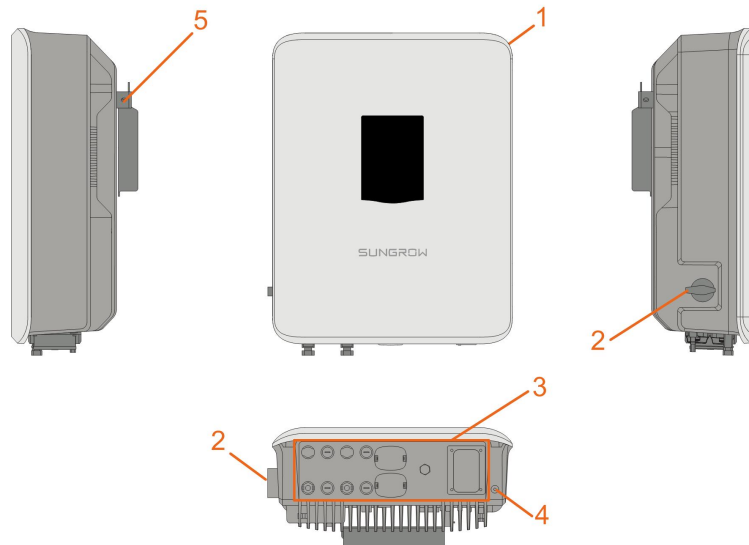

Figure 2-2 Appearance

\* The image shown here is for reference only. The actual product received may differ.

No.	Name	Description
1	LED indicator panel	Indicates the current working state of the inverter.
2	DC switch	Protective components for safely disconnecting DC side current.
3	Electrical connection area	Includes DC terminal, AC terminal and communication terminal.
4	Additional grounding terminal	User can connect this terminal as per requirements.
5	Hanger	Used to hang the inverter on the wall-mounting bracket.



## 2.2.3 Dimensions

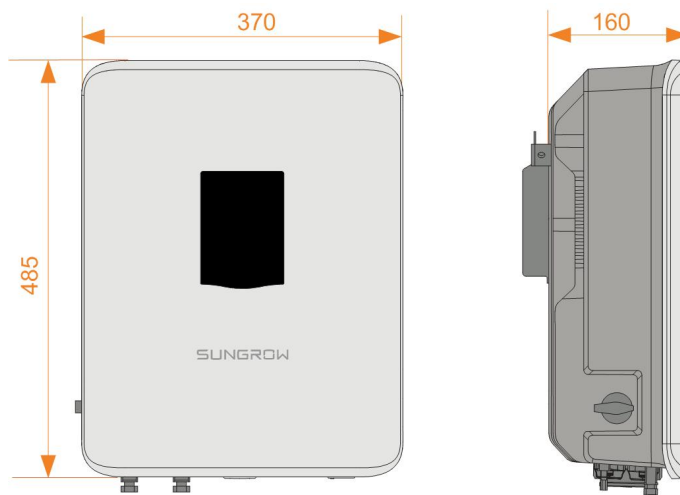

Figure 2-3 Dimensions of the inverter(in mm)

## 2.2.4 LED Indicator Panel

The LED indicator on the front of the inverter can indicate the current working state of the inverter.

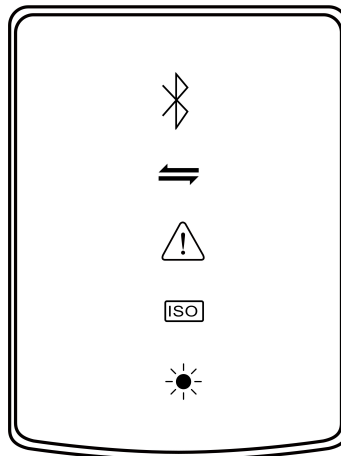







Figure 2-4 LED indicator panel

Table 2-2 State description of the LED indicator panel

LED indicator	LED color	LED state	Definition
Bluetooth 	Blue	ON	The Bluetooth has been connected, but there is no data exchange
		Flashing	The Bluetooth has been connected, and there is data exchange

LED indicator	LED color	LED state	Definition
Communicatio- 	Blue	OFF	No device is connected to the inverter through the bluetooth
		Flashing	The communication cable or communication module has been connected, and there is data exchange in the communication channel
		OFF	Neither the communication cable nor the communication module is connected, or there is no data exchange in the communication channel
Fault/PID 	Red	ON	A fault has occurred (the device cannot feed power into the grid)
		Flashing	The fault is being restored
	Green	ON	PID function is running
		Flashing	PID function exception
	-	OFF	No alarm or fault has occurred and PID function is not enabled
Earth impedance abnormal 	Red	ON	An earthing short circuit has occurred (the device cannot feed power into the grid)
		OFF	No fault occurs
Normal operation 	Green	ON	The device is connected to the grid and operates normally
		Flashing	The DC or AC side has been powered on and the device is in standby or startup state (has not fed power into the grid)
		OFF	Both the AC and DC sides have been powered off, or a fault occurs

### 2.2.5 DC Switch

The DC switch is used to safely disconnect the DC circuit whenever necessary.

The inverter operates automatically when input and output requirements are met. Rotate the DC switch to the “OFF” position to stop the inverter when a fault occurs or when you need to stop the inverter.



Turn the DC switch to the “ON” position before restarting the inverter.

## 2.3 Circuit Diagram

The MPPT is utilized for DC input to ensure the maximum power from the PV array at different PV input conditions.

The inversion circuit converts the DC power into AC power and feeds the AC power to the utility grid through the AC terminal. The protection circuit is equipped to ensure the safe operation of the device and personal safety.

The DC switch is used to disconnect the DC current safely. The inverter is provided with standard RS485 ports for communication. Users can check running data and set related parameters via the iSolarCloud App.

"Figure 2-5 Circuit diagram" shows the main circuit of the inverter.

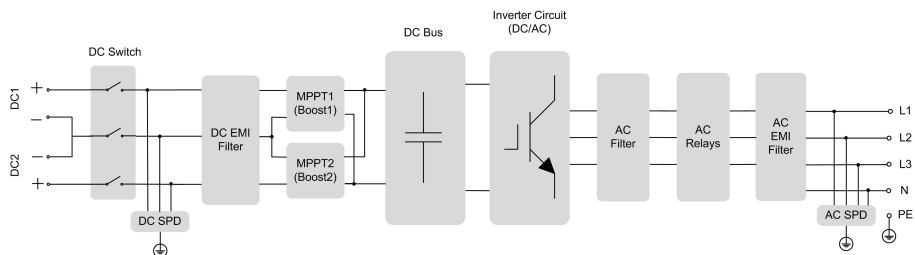

Figure 2-5 Circuit diagram

## 2.4 Function Description

### Conversion function

The inverter converts the DC current into grid-compatible AC current and feeds the AC current into grid.

### Data storage

The inverter logs running information, error records, etc.

### Parameter setting

The inverter provides various settable parameters. Users can set parameters via the App to meet the requirements and optimize the performance.

### Communication interface

The inverter is designed with standard RS485 communication interfaces and communication accessory port.

- The standard RS485 communication interfaces are used to establish communication connection with monitoring devices and upload monitoring data by using communication cables.
- The communication accessory port is used to connect communication module manufactured by SUNGROW, and upload monitoring data by means of wireless communication.

The inverter can be connected to communication devices via either of the two interfaces. After communication connection is established, users can view inverter information or set inverter parameters through the iSolarCloud.



It is recommended to use the communication module from SUNGROW. Using a device from other companies may lead to communication failure or other unexpected damage.

### Protection Function

- Short-circuit protection
- Ground insulation resistance monitoring
- Grid voltage monitoring
- Grid frequency monitoring
- Leakage current protection
- Monitoring on DC injection of AC output current
- Anti-islanding protection
- Ambient temperature monitoring
- DC over-voltage protection
- Over-current protection
- Power module over-temperature protection
- PID recovery function (optional)

### PID Recovery Function (Optional)

After the PID function is enabled, the voltage to ground of all PV modules is greater than 0, that is, the PV module-to-ground voltage is a positive value.

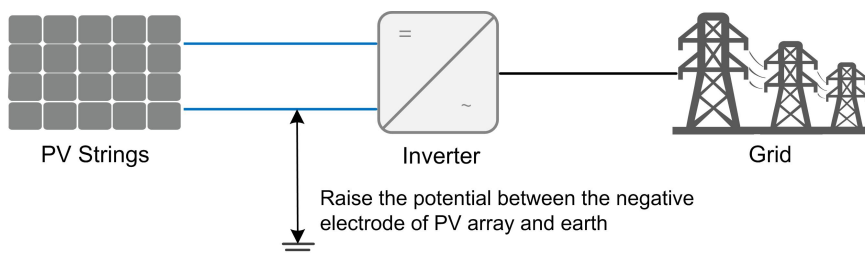

**NOTICE**

- Before enabling the PID recovery function, make sure the voltage polarity of the PV modules to ground meets requirement. If there are any questions, contact the PV module manufacturer or read its corresponding user manual.
- If the voltage scheme for the PID recovery function does not meet the requirement of corresponding PV modules, the PID function will not work as expected or even damage the PV modules.

When the inverter is not running, the PID module will apply inverse voltage to PV modules, to restore the degraded modules.



- If the PID recovery function is enabled, it only works at night.
- After the PID recovery function is enabled, the voltage of the PV string to ground is 500Vdc by default, and the default value can be modified through the App.

## 3 Unpacking and Storage

### 3.1 Unpacking and Inspection

The inverter is thoroughly tested and strictly inspected before delivery. Damage may still occur during shipping. For this reason, please conduct a thorough inspection after receiving the device.

- Check the packing case for any visible damage.
- Check the scope of delivery for completeness according to the packing list.
- Check the inner contents for damage after unpacking.

Contact SUNGROW or the supplier in case of any damage or incompleteness.

Do not dispose of the original packing case. It is recommended to store the inverter in it.

### 3.2 Identifying the Inverter

The nameplate can be found on both the inverter and the packing case. It provides information on model of inverter, important specifications, marks of certification institutions, and serial numbers which are available and identified by SUNGROW. Take SG5KTL-MT as an example.

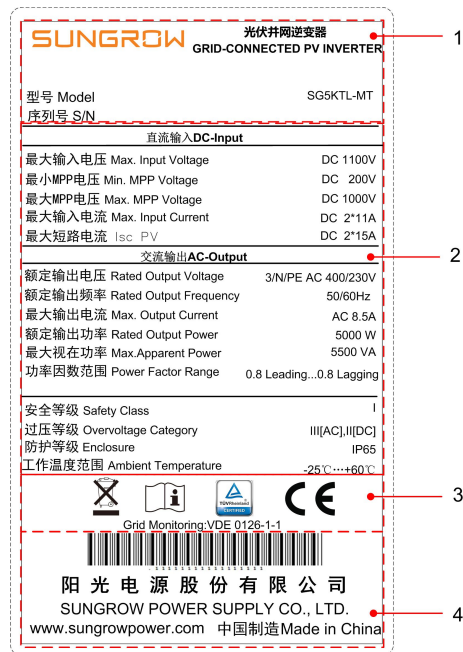

Figure 3-1 Nameplate of Inverters

\* The image shown here is for reference only. The actual product received may differ.

Item	Description
1	SUNGROW logo and product model
2	Technical data of inverter
3	Instructions and marks of conformity
4	Company name, website and country of manufacture

Table 3-1 Description of Icons on the Nameplate

Icon	Description
	Do not dispose of the inverter together with household waste
	Refer to the corresponding instructions
	TÜV mark of conformity
	CE mark of conformity

### 3.3 Scope of Delivery

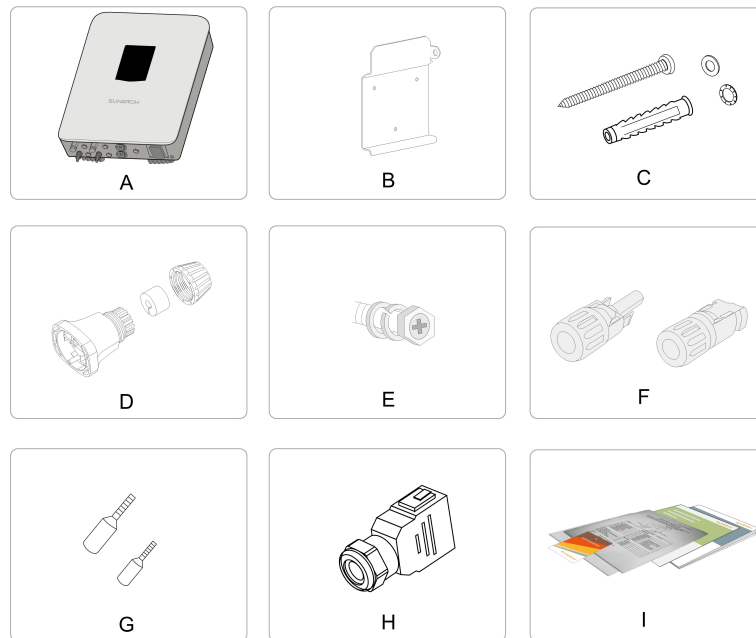

Figure 3-2 Scope of delivery

Item	Name	Quantity	Description
A	Inverter	1 set	-
B	Wall-mounting bracket	1 pcs	Used to connect the inverter to the installation site.
C	Nylon bolts	3 sets	Used to fasten wall-mounting bracket onto concrete wall
D	Communication connectors	2 sets	Used to connect communication terminal. (one set is optional)
E	Screw	1 pcs	Used to lock the inverter mounting ears and hanging boards.
F	PV input connectors	2 pairs	Including positive and negative connectors, used to connect PV input.
G	Cord end terminal	2 specifications	There are cord end terminals of two specifications (5 for each specification) used to connect AC cables. Select appropriate terminals according to the cable cross-section area.



Item	Name	Quantity	Description
H	AC output connectors	1 pcs	Used to connect PV output, contains two layers of rubber gasket. The inner gasket needs to be removed when the outer diameter of AC cable is 19~25mm.
I	Documents	1 set	Quality certificate, packing list, test report and quick user manual

\* There are two communication port versions for the inverter: single port and dual ports. For details, refer to the product you receive. The inverter with single communication port is equipped with one set of communication connector, and the inverter with dual communication ports is equipped with two sets of communication connectors.

### 3.4 Inverter Storage

Proper storage is required if the inverter is not installed immediately.

- Store the inverter in the original packing case with the desiccant inside.
- The storage temperature must be always between  $-40^{\circ}\text{C}$  and  $+70^{\circ}\text{C}$ , and the storage relative humidity must be always between 0 and 95 %, non-condensing.
- In case of stacking storage, the number of stacking layers should never exceed the limit marked on the outer side of the packing case.
- The packing should be upright.
- If the inverter has been stored more than half a year, the qualified personnel should thoroughly check and test it before installation.

## 4 Mechanical Mounting

### 4.1 Safety during Mounting

#### DANGER

Make sure there is no electrical connection before installation.

In order to avoid electric shock or other injury, make sure that holes will not be drilled over any electricity or plumbing installations.

#### CAUTION

Risk of injury due to improper handling

- Always follow the instructions when moving and positioning the inverter.
- Improper operation may cause injuries or serious wounds. In the case of poor ventilation, the system performance may compromise.
- Keep the heat sinks uncovered to ensure heat dissipation performance.

### 4.2 Location Requirements

Select an optimal mounting location for safe operation, long service life and expected performance.

- The inverter with IP 65 can be installed both indoors and outdoors.
- Install the inverter in a place convenient for electrical connection, operation, and maintenance.

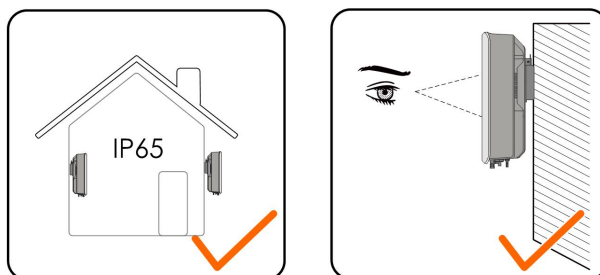

#### 4.2.1 Installation Environment Requirements

- The installation environment must be free of inflammable or explosive materials
- The location should be not accessible to children

- The ambient temperature and relative humidity must meet the following requirements

Max.  
+60°C



Min.  
-25°C



Max. RH  
+100%



- Avoid direct exposure to sun, rain and snow
- The inverter should be well ventilated. Ensure air circulation
- Never install the inverter in living areas. The inverter will generate noise during operation, affecting daily life

#### 4.2.2 Carrier Requirements

The installation carrier should meet the following requirements:



Made of non-flammable materials



Max. load bearing capacity  $\geq$  4 times the inverter weight

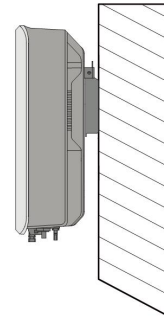

#### 4.2.3 Installation Angle Requirements

Never install the inverter horizontally, or with a forward tilt/backward tilt, or even upside down.

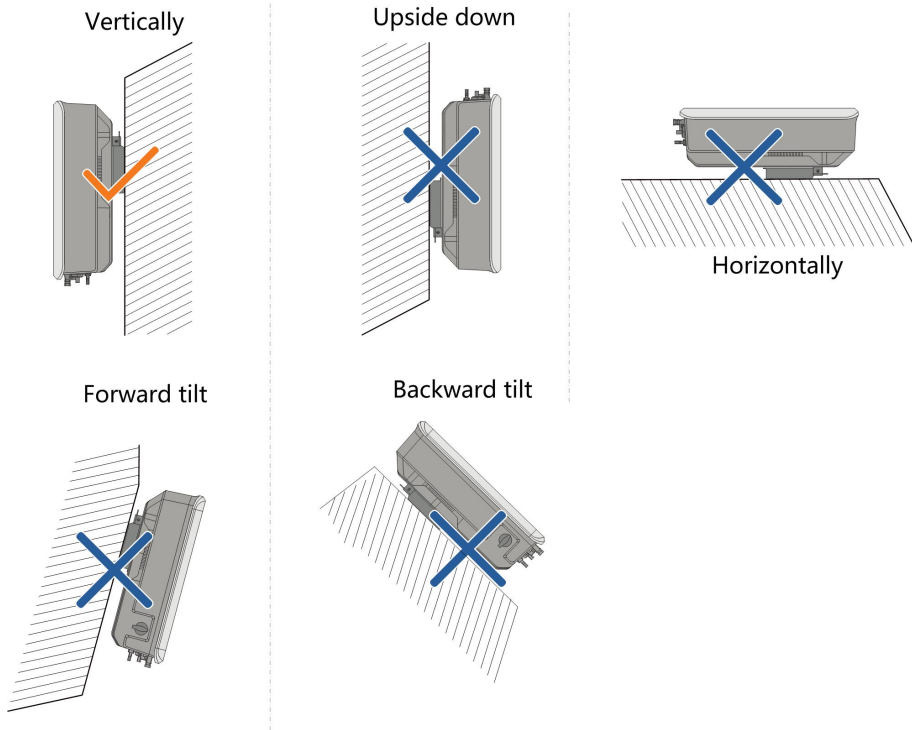

#### 4.2.4 Installation Clearance Requirements

- Reserve enough clearance around the inverter to ensure sufficient space for heat dissipation.

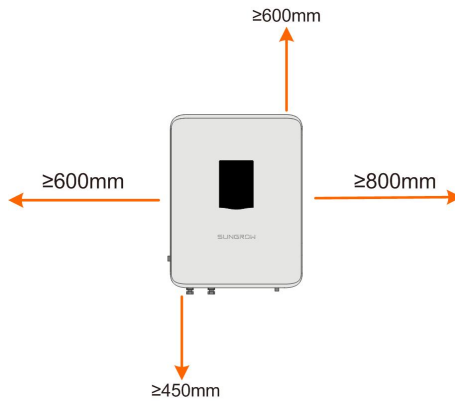

- In case of multiple inverters, reserve specific clearance between the inverters.

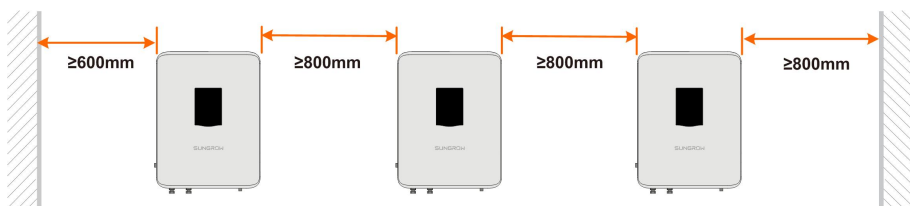

- Install the inverter at an appropriate height for ease of viewing LED indicators and operating switches.

### 4.3 Installation Tools

Installation tools include but are not limited to the following recommended ones. If necessary, use other auxiliary tools on site.



Table 4-1 Tool specification

No.	Specification
a	M5
b	M4
c	Drill bit: $\varnothing 10$
d	Crimp range: 2.5~6 mm <sup>2</sup>
e	Range $\geq 1100$ Vdc

## 4.4 Moving the Inverter

Before installation, remove the inverter from the packing case and move it to the installation site. Follow the instructions below as you move the inverter:

- Always be aware of the weight of the inverter.
- Lift the inverter using the handles positioned on both sides of the inverter.
- Move the inverter by at least two people or by using a proper transport tool.
- Do not release the equipment unless it has been firmly secured.

## 4.5 Installing the Inverter

Inverter is mounted onto the wall via the wall-mounting bracket enclosed in the packing. If you do not use the supplied wall-mounting bracket, you can drill holes as per specifications below:

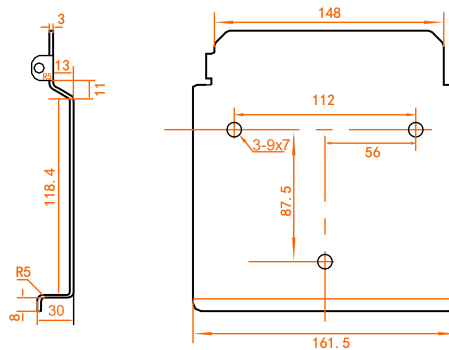
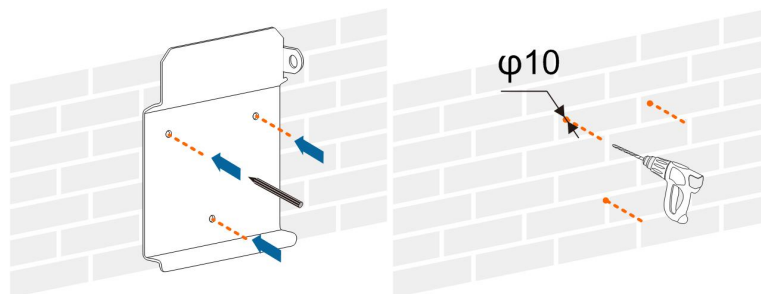

**Figure 4-1** Dimensions of the wall-mounting bracket (figures in mm)

**Step 1** Take out the wall-mounting bracket and corresponding fasteners from the packaging.

**Step 2** Place the wall-mounting bracket on the chosen concrete wall and adjust it to proper position and height.

**Step 3** Mark positions according to holes on the wall-mounting bracket, and drill holes according to the marks made before.



**⚠ DANGER**

Check to ensure that there is no other electronic or plumbing installed inside the wall before drilling holes.

**Step 4** Secure the wall-mounting bracket to the wall firmly with the supplied expansion bolt sets.

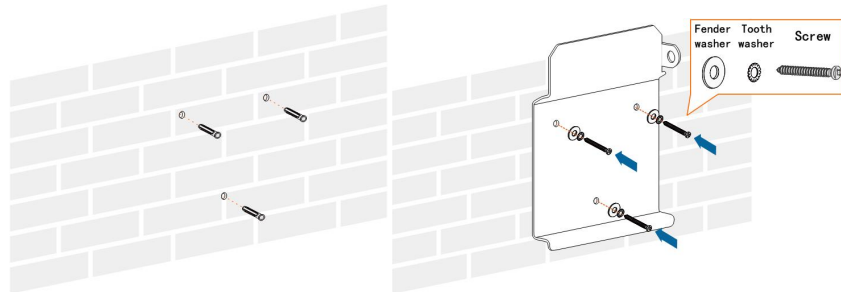

**Step 5** Lift the inverter and slide it down along the wall-mounting bracket to make sure they match perfectly. Use the fastener set to lock the device.

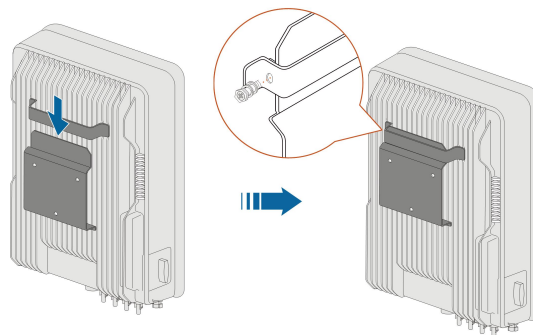

-- End

## 4.6 Connecting the Communication Module (Optional)

Connect the communication module GPRS, WiFi, or E-Net to the communication accessory port at the bottom of the inverter.



For detailed connection description of the communication module, refer to related user manual.

# 5 Electrical Connection

## 5.1 Safety Instructions

Prior to any electrical connections, keep in mind that the inverter has dual power supplies. It is mandatory for the qualified personnel to wear personal protective equipment (PPE) during the electrical work.

### DANGER

**Danger to life due to a high voltage inside the inverter!**

- The PV string will generate lethal high voltage when exposed to sunlight.
- Before starting electrical connections, disconnect the DC and AC circuit breakers and prevent them from inadvertent reconnection.
- Ensure that all cables are voltage free before performing cable connection.

### WARNING

- Any improper operations during cable connection can cause device damage or personal injury.
- Only qualified personnel can perform cable connection.
- All cables must be undamaged, firmly attached, properly insulated and adequately dimensioned.

### NOTICE

Comply with the safety instructions related to the PV strings and the regulations related to the utility grid.

- All electrical connections must be in accordance with local and national standards.
- Only with the permission of the local utility grid company, the inverter can be connected to the utility grid.

## 5.2 Terminal Description

All electrical terminals are located at the bottom of unit.



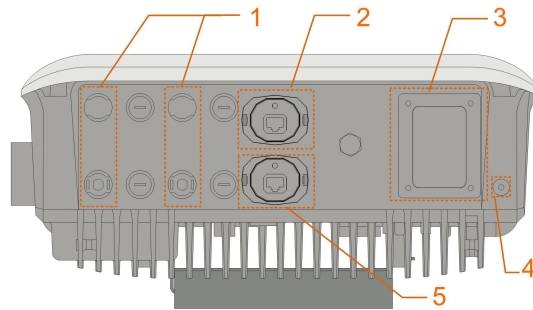

Figure 5-1 Terminal description

\* The image shown here is for reference only. The actual product received may differ.

No.	Name	Description
1	DC input plug-in terminal	MC4 terminals for PV input
2	Communication accessory port	Can be connected to GPRS, WiFi, or E-Net communication module
3	AC cable gland	AC terminals to the power grid
4	PE terminal	Additional grounding terminal
5	RS485 communication port (optional)	-



Enough space should be kept for electrical connection at the bottom of the inverter when choosing the installation site.

### 5.3 Additional Grounding Connection

#### ⚠ WARNING

- Since the inverter is transformerless, neither the negative pole nor the positive pole of the PV string must be grounded. Otherwise, the inverter will not operate normally.
- Connect the additional grounding terminal to the protective grounding point before AC cable connection, PV cable connection, and communication cable connection.
- The ground connection of this additional grounding terminal cannot replace the connection of the PE terminal of the AC cable. Make sure the two terminals are both grounded reliably.

#### 5.3.1 Additional Grounding Requirements

All non-current carrying metal parts and device enclosures in the PV power system should be grounded, for example, brackets of PV modules and inverter enclosure.

When there is only one inverter in the system, connect the additional grounding cable to a nearby grounding point.

When there are multiple inverters in parallel in the system, connect grounding points of all inverters and the PV array frames to the equipotential cable (according to the onsite conditions) to implement an equipotential connection.

### 5.3.2 Connection Procedure

The additional grounding cable should be of the same cross section as the PE wire in the AC cable.

Additional grounding cable and OT/DT terminal are prepared by customers.

**Step 1** Prepare the cable and OT/DT terminal.

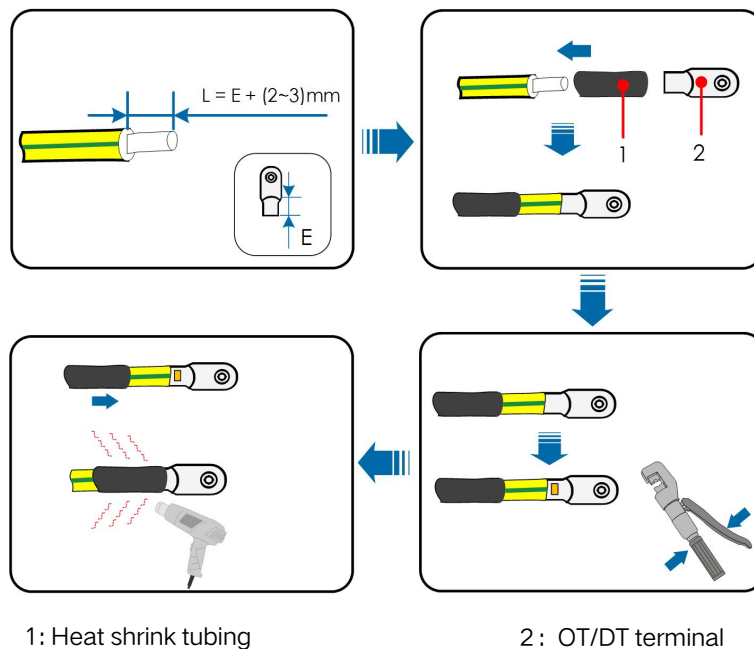

**Step 2** Remove the screw on the grounding terminal and fasten the cable with a screwdriver.

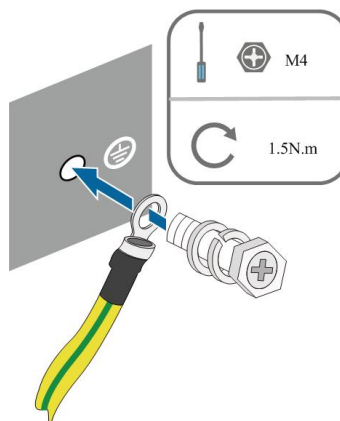

**Step 3** Apply paint to the grounding terminal to ensure corrosion resistance.

-- End

## 5.4 AC Cable Connection

### 5.4.1 AC Side Requirements



Connect the inverter to the grid only after getting an approval from the local electric power company.

Before connecting the inverter to the grid, ensure the grid voltage and frequency comply with requirements, for which, refer to "10.1 Technical Data". Otherwise, contact the electric power company for help.

#### AC Circuit Breaker

An independent three or four-pole circuit breaker must be installed on the output side of the inverter to ensure safe disconnection from the grid.

Inverter Model	Recommended AC circuit breaker current
SG5KTL-MT	16A
SG6KTL-MT	16A
SG8KTL-M	20A
SG10KTL-M	25A
SG12KTL-M	32A

#### NOTICE

- Multiple inverters cannot share one circuit breaker.
- Never connect a load between the inverter and the circuit breaker.

#### Residual Current Monitoring Device

With an integrated universal current-sensitive residual current monitoring unit included, the inverter will disconnect immediately from the mains power once a fault current with a value exceeding the limit is detected.

However if an external residual current device (RCD) is mandatory, the switch must be triggered at a residual current of 300 mA or higher.

#### Multiple Inverters in parallel Connection

If multiple inverters are connected in parallel to the grid, ensure that the total number of parallel inverters does not exceed 10. Otherwise, please contact SUNGROW for technical scheme.

#### Cable Requirements

Cross-section: 4~10 mm<sup>2</sup>, cable diameter: 12 mm to 25 mm

All the AC cables should be equipped with correctly colored cables for distinguishing. Please refer to related standards about the wiring color.

### 5.4.2 Assembling the AC Connector

The AC terminal block is on the bottom of the inverter. AC connection is the three-phase-four-wire grid +PE connection (L1, L2, L3, N, and PE).

**Step 1** Unscrew the waterproof terminal of the AC connector counter clockwise.

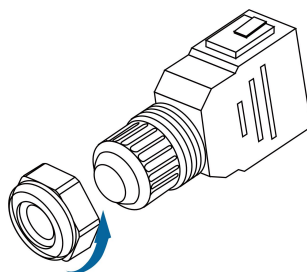

**Step 2 (Optional)** Remove the inner rubber gasket if the external diameter of the to-be-used AC cable ranges from 19~25mm.

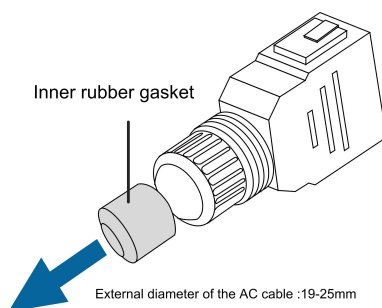

**Step 3** Thread the AC cable of appropriate length through the waterproof terminal.

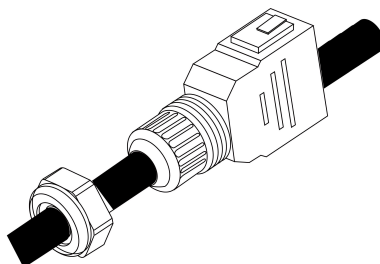

**Step 4** Remove the cable jacket by 80~90 mm, and strip the wire insulation by 12 mm.

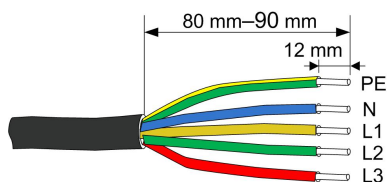

**Step 5** When using a multi-core multi-strand copper wire cable, connect the AC cable head to the cord end terminal by appropriate torque.

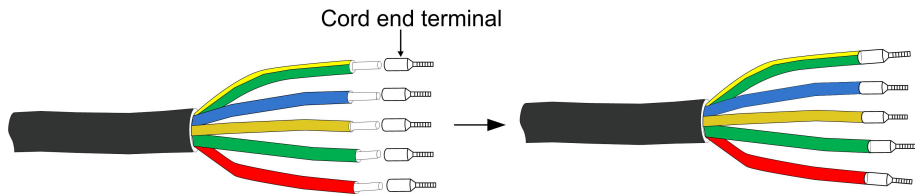

- Select appropriate cord end terminal according to the cable cross-section area.
- In case of single-strand copper wire, skip installing any cord end terminal.

**Step 6** Fix all cables to the corresponding terminals with torque of 1.2-1.5 N•m, according to markings on the connector with a screwdriver, especially the "PE" cable. Avoid connecting the phase line to the terminal of "PE" or "N" cable, and otherwise, the inverter will be damaged.

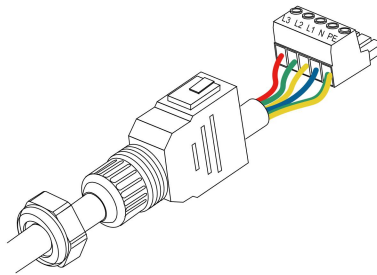

**Step 7** Pull cables outward to check whether they are firmly installed.

**Step 8** Connect the front and the back parts until there is an audible click.

**Step 9** Tighten the waterproof terminal clockwise.

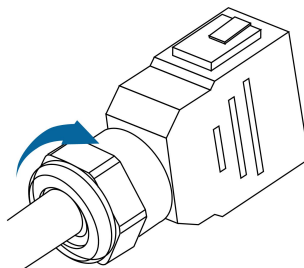

-- End

### 5.4.3 Installing the AC Connector

#### **DANGER**

High voltage may be present in inverter!

Ensure all cables are voltage-free before electrical connection.

Do not connect the AC circuit breaker until all inverter electrical connections are completed.

**Step 1** Disconnect AC circuit breaker secure it against reconnection.

**Step 2** Insert the AC connector into the input terminals on the bottom of the inverter until there is an audible sound.

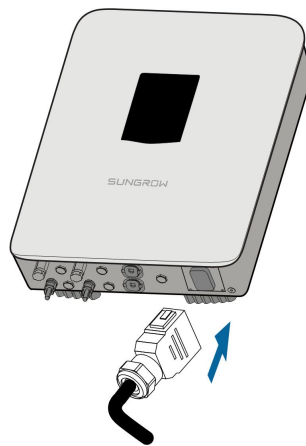

**Step 3 (Optional)** Insert the block, as shown in the figure below.

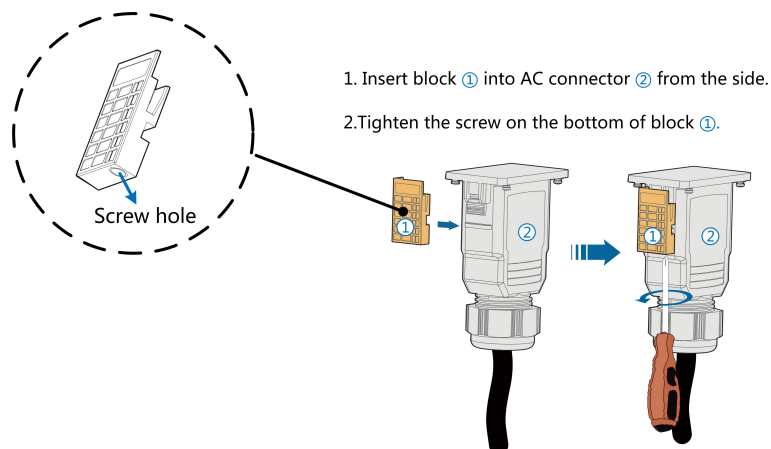

**Step 4** Connect PE cable to ground.

**Step 5** Connect phase cable and “N” cable to AC circuit breaker.

**NOTICE**

Observe the terminal layout on the block. Do not connect the phase wires to "PE" terminal or PE wire to "N" terminal. Otherwise, unrecoverable damage to the inverter may follow.

**Step 6** Connect AC circuit breaker to utility grid.

**Step 7** Make sure all AC cables are firmly installed via the right torque tool or dragging the cables slightly.

-- End

## 5.5 DC Cable Connection

**⚠ DANGER**

Danger of electric shock!

The PV array will generate lethal high voltage once exposed to sunlight.

**⚠ WARNING**

Make sure the PV array is well insulated to ground before connecting it to the inverter.

**NOTICE**

Risk of inverter damage! Observe the following requirements. Failure to do so will void guarantee and warranty claims.

- Make sure the maximum DC voltage and the maximum short circuit current of any string never exceed inverter permitted values specified in "Technical Data".
- Mixed use of different brand or model of PV modules in a PV string or a compromised PV string design composed with PV modules from rooftops of different orientation may not damage inverter but will cause system bad performance!
- The inverter enters the standby state when the input voltage ranges between 1,000V and 1,100V. The inverter returns to the running state once the voltage returns to the MPPT operating voltage range, namely, 200 to 1,000V.

### 5.5.1 PV Input Configuration

The inverter has two PV input areas PV1 input and PV2 input, each with its MPP tracker.

Each PV input operates independently and has its own MPPT. In this way, string structures of each PV input may differ from each other, including PV module type, number of PV modules in each string, angle of tilt, and installation orientation.

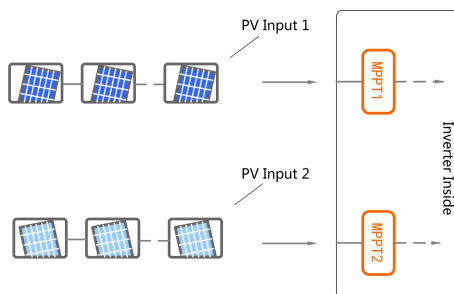

Prior to connecting the inverter to PV inputs, the following electrical specifications must be met simultaneously:

Inverter Model	Open-circuit Voltage Limit	Max. current for input connector
SG5KTL-MT	1100 V	15A
SG6KTL-MT		
SG8KTL-M		
SG10KTL-M		
SG12KTL-M		

## 5.5.2 DC Side Requirements

SUNGROW provides corresponding plug connectors in the scope of delivery for quick connection of PV inputs. DC cables should be connected to the inverter via PV connectors which are included in the scope of delivery.



To ensure IP65 protection, use only the supplied connector or the connector with the same ingress of protection.

### DC Cable Requirements

Table 5-1 DC Cable Requirements

Cross-section Area	Cable Diameter	Max. Withstand Voltage	Max. Withstand Current
2.5 to 6 mm <sup>2</sup>	6 to 9 mm	1100 V	15 A

#### NOTICE

- The DC cable must be multi-core cable.
- The input current of each input channel should be less than 15A.



### 5.5.3 Assembling the PV Connector

#### **⚠ DANGER**

High voltage may be present in the inverter!

- Ensure all cables are voltage-free before performing electrical operations.
- Do not connect the AC circuit breaker before finishing electrical connection.

#### **⚠ CAUTION**

- Use MC4 DC terminals if the maximum input voltage is no more than 1,000V.
- Use MC4 – Evo2 DC terminals if the maximum input voltage is greater than 1,000V. To purchase the MC4 – Evo2 DC terminals, contact SUNGROW.
- Select appropriate DC terminals as required above. Otherwise, SUNGROW shall be held no liability for the damage caused.

**Step 1** Strip the insulation from each DC cable by 7mm.

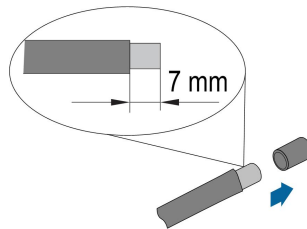

**Step 2** Assemble cable ends with crimp contacts by crimping pliers.

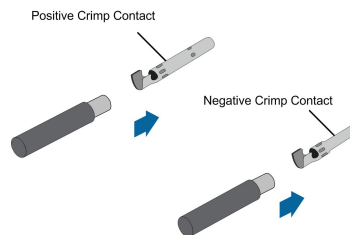

**Step 3** Lead the cable through cable gland. Insert the crimp contact into the insulator until it snaps into place. Gently pull the cable backward to ensure firm connection. Tighten the cable gland and the insulator (torque  $2.5 \text{ N} \cdot \text{m}$  to  $3 \text{ N} \cdot \text{m}$ ).

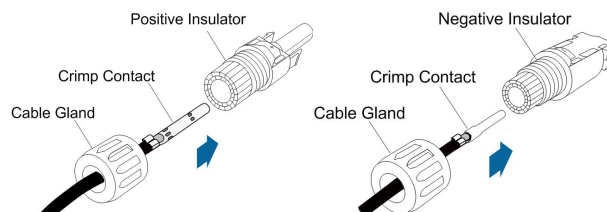



For further assembly and connection instruction, please visit the website of the device manufacturer.

**Step 4** Check for polarity correctness.

**NOTICE**

The inverter will not function properly if any PV polarity is reversed.

-- End

#### 5.5.4 Installing the PV Connector

**Step 1** Rotate the DC switch to “OFF” position.

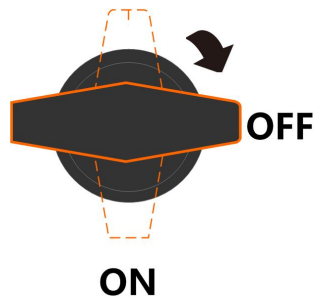

**Step 2** Check the cable connection of the PV string for polarity correctness and ensure that the open circuit voltage in any case does not exceed the inverter input limit of 1,100V.

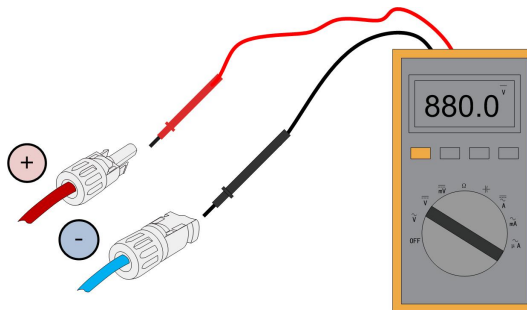

**Step 3** Connect the PV connectors to corresponding terminals until there is an audible click.

**NOTICE**

- Check the positive and negative polarity of the PV strings, and connect the PV connectors to corresponding terminals only after ensuring polarity correctness.

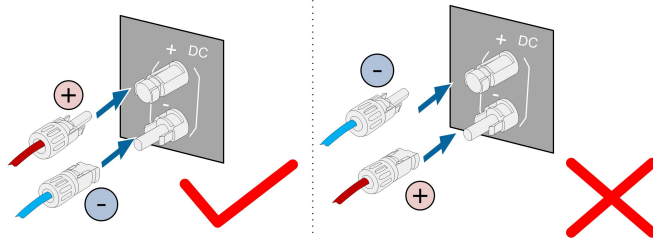

- Arc or contactor over-temperature may occur if the PV connectors are not firmly in place, and SUNGROW shall not be held liable for any damage caused due to this operation.

**Step 4** Follow the foregoing steps to connect PV connectors of other PV strings.

**Step 5** Seal any unused PV terminal with a terminal cap.

-- End

## 5.6 RS485 Communication System

As for one inverter, an RS485 cable can guarantee the communication connection.

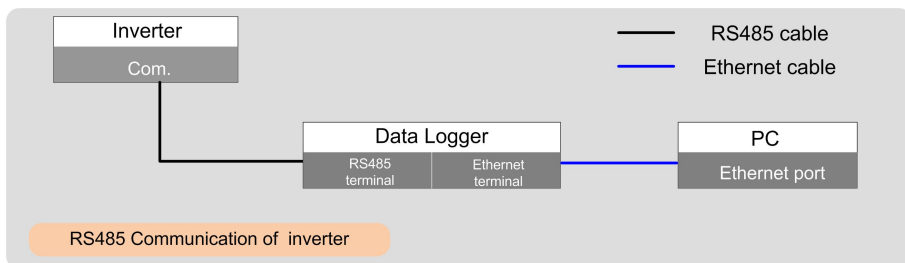

Prepare communication cable before communication connection.

**NOTICE**

RS485 communication cables should be:

- Shielded cables or Shielded Ethernet cables.
- Applicable to outdoor installation.



A converter such as Data Logger is needed to convert signal between inverter and PC.

The communication accessory port can directly connect to communication modules produced by SUNGROW, such as GPRS, WiFi, or E-Net, for which, refer to the section "5.7 GPRS Communication System (Optional)" and the section "5.8 Ethernet Communication System (Optional)". Alternatively, via RS485 communication cable, the communication accessory port can connect to other communication devices, such as Logger.

The RS485 communication port is configured to connect Smart Energy Meters, for which refer to the section "5.9 Smart Energy Meter Connection (Optional)". In addition, the port can be used for communications between inverters connected in the daisy chain manner.



Not inverters of all types can be connected via the RS485 cable in the daisy chain manner and communicate with each other. Contact SUNGROW to ensure that the purchased devices support communications between multiple inverters before connecting them in the daisy chain manner.

Proceed as follows to connect other external communication devices to the communication accessory port via the RS485 communication cable.

**Step 1** Strip the insulation layer of the communication cable with an Ethernet wire stripper, and lead the corresponding RS485A/B signal cables out.

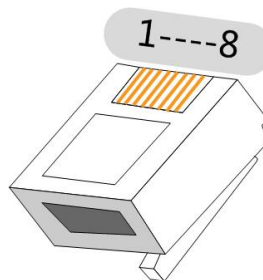

Figure 5-2 RJ45 plug

Table 5-2 Pin definitions of the RJ45 plug

RJ45 connector	Pin	Color	Description
TIA/EIA 568A	3	White-orange	RS485- B
	6	Orange	RS485+ A
TIA/EIA 568B	3	White-green	RS485- B
	6	Green	RS485+ A



Pin 1 and pin 2 are configured to supply power for communication modules. Never connect or use these two pins when preparing the RS485 communication cable. Otherwise, damage can be caused to inverters or other devices connected through the communication cable.

**Step 2** Insert the stripped communication cable into the RJ45 plug in the correct order, and crimp it with a crimper.

**Step 3** Insert the RJ45 plug into the front plug connector until it makes a clicking sound, install the plastic rings then tighten the cable gland with appropriate torque.

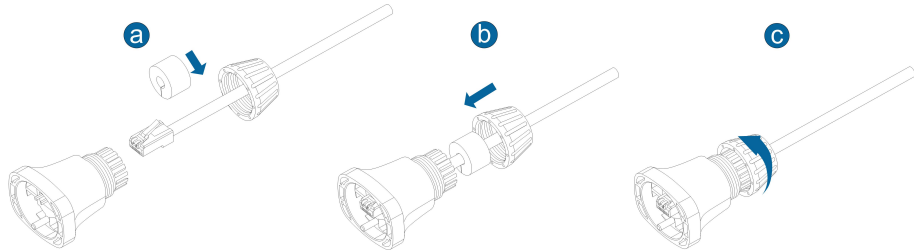

**Step 4** Insert connector of one cable end into Com. terminal on the bottom of the inverter. Make connector and Com. terminal engage and rotate clockwise.

**Step 5** Pull cables outward to confirm whether they are fastened firmly.



Set the communication parameters via the App if more than one inverter is connected to PC or Logger.

-- End

## 5.7 GPRS Communication System (Optional)

Connect the GPRS module produced by SUNGROW to the communication accessory port. After successful connection, information such as power generation and running state of the inverter can be viewed via the App on the phone.

The block diagram of the GPRS communication system is as follows:

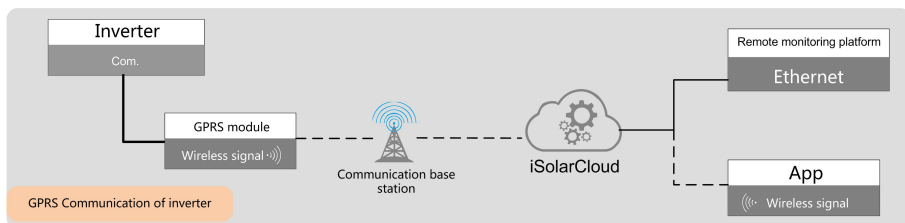

### NOTICE

The GPRS communication and the RS485 communication are not available at the same time. Otherwise, communication failure or other problems can be caused.



For details on module installation and configuration, refer to the manual delivered together with the module.

## 5.8 Ethernet Communication System (Optional)

Connect the WiFi or E-Net module produced by SUNGROW to the communication accessory port. After successful connection, information such as power generation and running state of the inverter can be viewed via the App on the phone.

The block diagram of the Ethernet communication system is as follows:

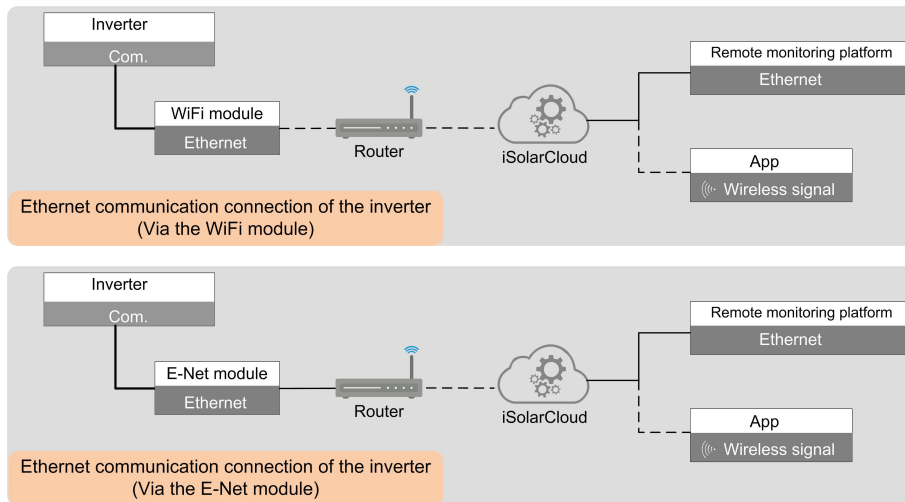

### NOTICE

The Ethernet communication and the RS485 communication are not available at the same time. Otherwise, communication failure or other problems can be caused.



For details on module installation and configuration, refer to the manual delivered together with the module.

## 5.9 Smart Energy Meter Connection (Optional)

The inverter is equipped with the feed-in power limit function, so as to meet the requirements of some national standards or grid standards for the output power at the grid connection point. For the setting of feed-in power limit, refer to the section "[7.7.4 Feed-in Limitation \(Optional\)](#)".



Contact SUNGROW to ensure that the Smart Energy Meter model is available locally.

### 5.9.1 On the Smart Energy Meter Side

For details, refer to the Quick Installation Guide of Smart Energy Meter.

### 5.9.2 On the Inverter Side

Proceed as follows to connect the RS485 communication cable to the inverter:

**Step 1** Prepare the RJ45 plug. Specifically, refer to the related description in section "5.6 RS485 Communication System".



Skip performing the foregoing step 1 when the RS485 communication cable has been prepared.

**Step 2** Insert the RJ45 plug into the front plug connector until it makes a clicking sound, install the plastic rings then tighten the cable gland with appropriate torque.

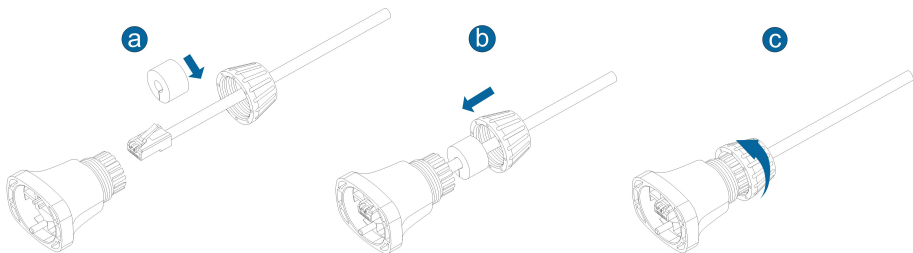

**Step 3** Insert connector of one cable end into Meter / RS485 terminal on the bottom of the inverter. Make connector and Meter / RS485 terminal engage and rotate clockwise.

**Step 4** Pull cables outward to confirm whether they are fastened firmly.

-- End

## 6 Commissioning

### 6.1 Inspection before Commissioning

Check the following items before starting the inverter:

- The inverter DC switch and external circuit breaker are disconnected.
- The inverter should be accessible for operation, maintenance and service.
- Nothing is left on the top of the inverter.
- The inverter is correctly connected to the external devices, and the cables are routed in a safe place or protected against mechanical damage.
- The selection of the AC circuit breaker is in accordance with this manual and all applicable local standards.
- All unused terminals at the bottom of the inverter are properly sealed.
- Warning signs & labels are intact and legible.

### 6.2 Commissioning Procedure

If all of the items mentioned above meet the requirements, proceed as follows to start up the inverter for the first time.

**Step 1** Rotate the DC switch of the inverter to "ON" position.

**Step 2** Connect the AC switch (if applicable) between the inverter and the grid.

**Step 3** Connect the DC switch (if applicable) between the inverter and the PV string.

**Step 4** Set initial protection parameters via the iSolarCloud App. For details, please refer to "[7.3.2 Login Steps](#)". If the irradiation and grid conditions meet requirements, the inverter will operate normally.

**Step 5** Observe the LED indicator to ensure that the inverter operates normally. (Refer to "[Table 2-2 State description of the LED indicator panel](#)").

-- End



# 7 iSolarCloud App

## 7.1 Brief Introduction

The iSolarCloud App can establish communication connection to the inverter via the WLAN, providing remote monitoring, data logging and near-end maintenance on the inverter. Users can also view inverter information and set parameters through the App.

\* To achieve direct login via WLAN, the WiFi wireless communication module developed and manufactured by SUNGROW is required. The iSolarCloud App can also establish communication connection to the inverter via the base station or Bluetooth.



- This manual describes only how to achieve near end maintenance via WLAN direct connection.
- Screenshots in this manual are based on the V2.1.6 App for Android system, and the actual interfaces may differ.

## 7.2 Download and Install

### Method 1

Download and install the App through the following application stores:

- MyApp (Android, mainland China users)
- Google Play (Android, users other than mainland China ones)
- App store (iOS)

### Method 2

Scan the following QR code to download and install the App according to the prompt information.



The App icon appears on the home screen after installation.



iSolarCloud

## 7.3 Login

### 7.3.1 Requirements

The following items should meet requirements:

- The AC and DC sides or the AC side of the inverter is powered-on.
- The WLAN function of the mobile phone is enabled.
- The mobile phone is within the coverage of the wireless network produced by the of the WiFi module.

### 7.3.2 Login Steps

**Step 1** Connect the mobile phone to the WLAN network named as "SG-WiFi Module Serial Number" (the serial number is on the side of the WiFi module). The communication indicator flashes blue once the connection is established.

**Step 2** Open the App to enter the login screen, and tap "Local Access" to enter the next screen.

**Step 3** Select "WLAN", enter the password, and tap "LOGIN".



The default account is "user" and the initial password is "pw1111" which should be changed for the consideration of account security.

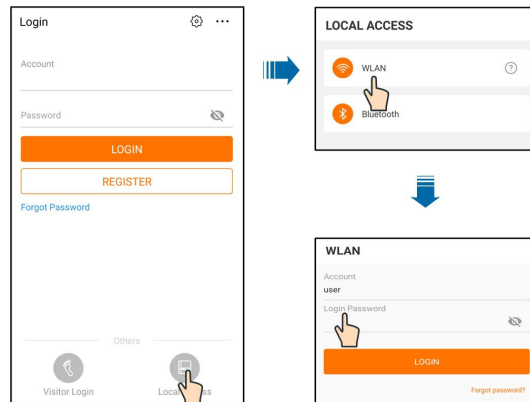

Figure 7-1 WLAN Direct

**Step 4** If the inverter is not initialized, navigate to the quick setting screen to initialize protection parameter. After finishing settings, tap “Boot” at the top right corner and the device will be initialized. The App will send start instructions and the device will start and operate.



Figure 7-2 Initialization protection parameter

#### NOTICE

The "Country (region)" must be set to the country where the inverter is installed. Otherwise, the inverter may report errors.

**Step 5** After initialization settings, the App will return automatically to the home page.

-- End

## 7.4 Function Overview

The App provides parameter viewing and setting functions, as shown in the following figure.

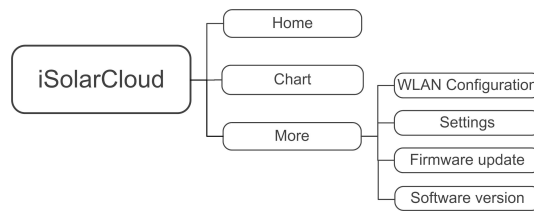

Figure 7-3 App function tree map

## 7.5 Home

Home page of the App is shown in the following figure.

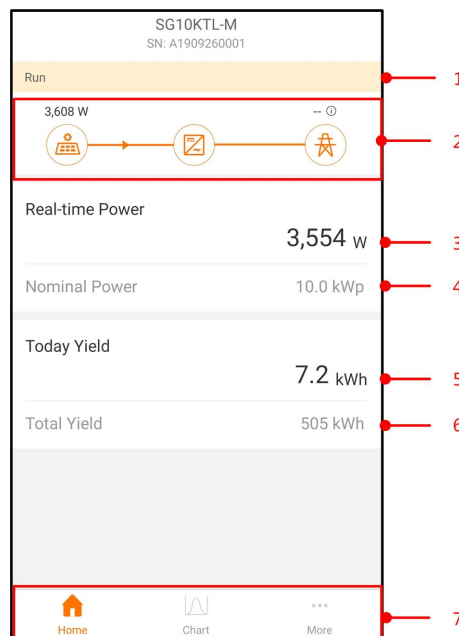



Figure 7-4 Home

Table 7-1 Home page description

No.	Name	Description
1	Inverter state	Present operation state of the inverter
2	Load flow chart	Shows the PV power generation power, feed-in power, etc. The line with an arrow indicates energy flow between connected devices, and the arrow pointing indicates energy flow direction.
3	Real-time power	Shows the present output power of the inverter.
4	Nominal power	Shows the installed power of the inverter.

No.	Name	Description
5	Today yield	Shows today power generation of the inverter
6	Total yield	Shows accumulative power generation of the inverter
7	Navigation bar	Includes menus of "Home", "Chart", and "More".

If the inverter runs abnormally, the fault icon  appears on the upper left corner of the screen. Users can tap the icon to view detailed fault information and corrective measures.

## 7.6 Chart

The App displays power generation records in a variety of forms, including daily power generation graph, monthly power generation histogram, annual power generation histogram, and total power generation histogram.

**Table 7-2** Description of power generation records

Item	Description
Daily power generation graph	The curve that shows change of power between 5 AM and 23 PM every day.(Each point on the curve corresponds to a power value).
Monthly power generation histogram	Shows information such as monthly power generation and month equivalent hours.
Annual power generation histogram	Shows information such as total E-annual and year equivalent hours.
Total power generation histogram	Shows information such as total power generation and total equivalent hours.

**Step 1** Tap "Chart" on the navigation bar to enter the screen showing daily power generation, as shown in the following figure.

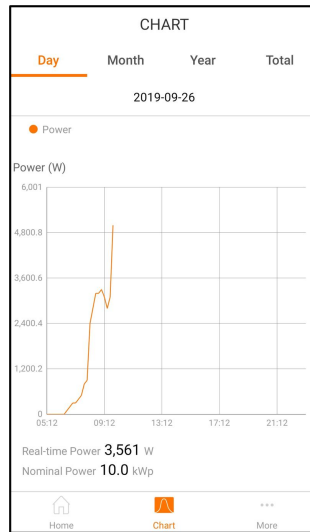

Figure 7-5 Power curve

**Step 2** Slide the screen left to view monthly power generation histogram, annual power generation histogram, and total power generation histogram.

-- End

## 7.7 More

Tap "More" on the navigation bar to enter the "More" screen, as shown in the following figure.

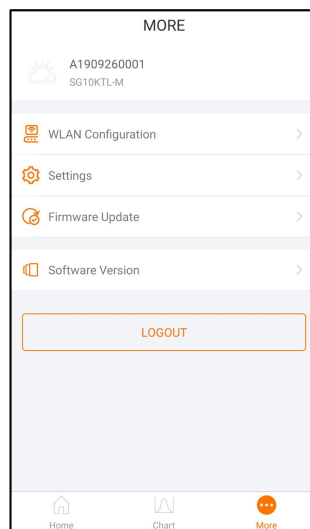
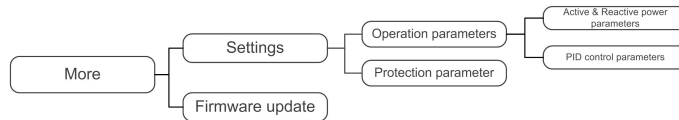

Figure 7-6 More



The "More" screen supports the following operations:

- Set parameters including inverter operation parameters, protection parameters, and power regulation.
- Upgrade inverter firmware (ARM/DSP/PVD/CPLD).

## 7.7.1 Operation Parameters

### Active & reactive power parameters

Table 7-3 Description of Active & reactive power parameters

Parameter	Description	Default	Range
Pac Limit	Inverter active power limitation	110.0%*	0~110%
Speed control	Set whether to enable speed control	[OFF]	[OFF]/ [ON]
Active power ascent speed	-	100%/min	8~6000%/min
Active power descent speed	-	6000%/min	8~6000%/min
Fault slow start	Set whether to enable fault slow start	[OFF]	[OFF]/ [ON]
Power increase speed	-	100%/min	8~100%/min
Reactive adjusting switch	-	[OFF]	[OFF]/ [Pf] [Qt] [Q(p)] [Q(u)]
PF	-	1.000	-1000~-800/ 800~1000(Unit 0.001)
Reactive power limit	Inverter reactive power limitation	0.0%	-100%~100%
Active setting keep	Set up whether to perpetually save the active power settings or not	[OFF]	[OFF]/ [ON]
Limited power	-	[ON]	[OFF]/ [ON]
Reactive setting keep	Set up whether to perpetually save the reactive power settings or not	[ON]	[OFF]/ [ON]

\* The default value for some devices is 100.0%.

### Reactive power regulation

The inverter provides a reactive power regulation function. Use the “Reactive adjusting switch” parameter to activate this function and select proper regulation mode.

**Table 7-4** Descriptions of reactive power regulation modes:

Mode	Descriptions
OFF	The PF is limited to +1.000, and the “Q-Var limits” is limited to 0.0%.
Pf	The reactive power can be regulated by the parameter PF (Power Factor).
Qt	The reactive power can be regulated by the parameter Q-Var limits (in %).
Q(P)	The PF changes with the output power of the inverter.
Q(U)	The reactive power changes with the grid voltage.

#### “OFF” Mode

Reactive power cannot be regulated. The PF is limited to +1.000, and the Q-Var limit is limited to 0.0%.

#### “Pf” Mode

The reactive power can be regulated by the parameter PF on the Run-param screen.

#### “Qt” Mode

The reactive power can be regulated by the parameter Q-Var limits (in %) on the Run-parameter screen.

#### “Q(P)” Mode

PF changes with the inverter output power.

**Table 7-5** Q(P) Mode Parameter Descriptions:

Parameter	Description	Default	Range
Lower Power*	Output power of point P1 in the Q(P) mode curve (in %)	50%	0%~50%
Upper Power*	Output power of point P2 in the Q(P) mode curve (in %)	100%	50%~100%
Upper limit_PF (Cap)	Power factor of point P1 in the Q(P) mode curve	1.000	0.900~1
Lower limit_PF (Ind)	Power factor of point P2 in the Q(P) mode curve	0.900	0.900~1

\* Lower Power < Upper Power

Note: According to the regulations and standards of different countries or regions, the default values will be different.



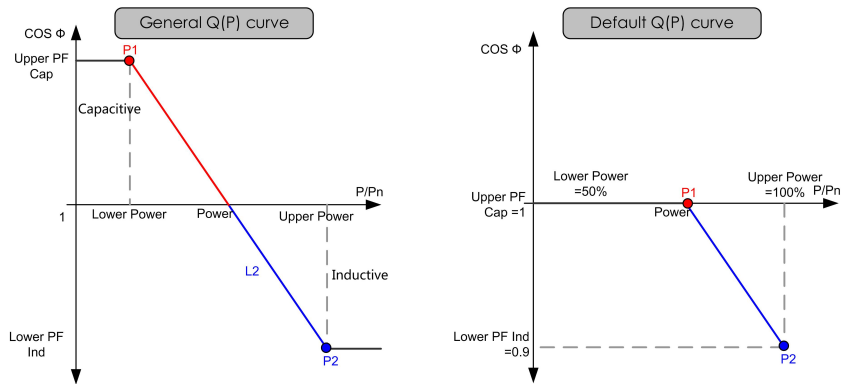

Figure 7-7 Reactive Power Regulation Curve in Q(P) Mode

### “Q(U) ” Mode

The reactive power ratio changes with the grid voltage.

Table 7-6 “Q(U) ” Mode Parameter Descriptions:

Parameter	Description	Default		Range	
		General region	Australia	General region	Australia
Lower U Limit	Grid voltage limit (in %) of point P1 in the Q(U) mode curve	80%	90%	80%~100%	-
U1 Limit*	Grid voltage limit (in %) of point P2 in the Q(U) mode curve	95%	95.6%	90% ~ 109.9%	93.9% ~ 100%
U2 Limit*	Grid voltage limit (in %) of point P3 in the Q(U) mode curve	105%	108.7%	100% ~ 110%	102% ~ 110.9%
Upper U Limit	Grid voltage limit (in %) of point P4 in the Q(U) mode curve	115%	115%	100% ~ 120%	106% ~ 115%
Hysteresis*	Hysteresis voltage width (in %)	3%	3%	0% ~ 5%	0% ~ 5%

Parameter	Description	Default		Range	
		General region	Australia	General region	Australia
Lower Q/Sn	Inductive Q/Sn value of point P4 in the Q(U) mode curve	25%	30% lagging	0% ~ 50%	0~ 60% lagging
	Capacitive Q/Sn value of point P1 in the Q(U) mode curve	25%	30%	0% ~ 50%	0~ 60%

\*  $U1 \text{ Limit} + \text{Hysteresis} < U2 \text{ Limit} - \text{Hysteresis}$

Note: According to the regulations and standards of different countries or regions, the default values will be different.

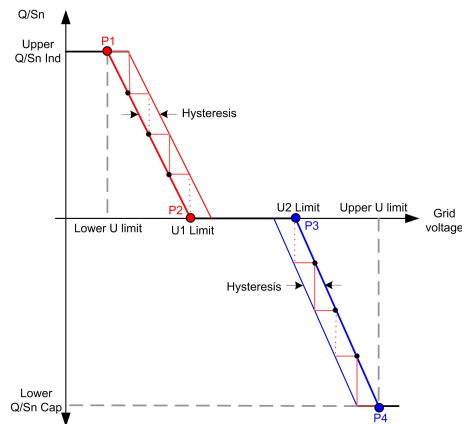

Figure 7-8 Reactive Power Regulation Curve in Q(U) Mode

### PID control parameters

Table 7-7 PID control parameters

Parameter	Description
PID Recovery (Night)	Set enabling/disabling of the PID night recovery function. PID night recovery functions between 22:00 pm and 5:00 am by default.
PID alarm cleared	If ISO impedance abnormality or PID function exception is detected during running of the PID function, the inverter reports a PID false alarm and reminds the user to take corresponding measures. After processing, the alarm information can be cleared via the function.



After the PID night recovery function is enabled, the fault indicator on the inverter main panel turns green.

## 7.7.2 Protection Parameter



- User with this account can only view protection parameters, and default values of these protection parameters have been set according to corresponding grid standards.
- To modify protection parameters, contact SUNGROW to obtain the advanced account and corresponding password.

Table 7-8 Protection parameter description

Parameter	Definition/Setting description
Country(region)	Depends on the location of the plant
Grid type*	Depends on the grid standards
Protection level	The level of protection of over/under-voltage and over/under-frequency
Single-level protection value	See " <a href="#">Table 7-9 Single-level Protection Parameters Explanation</a> "
Multi-level protection values	See " <a href="#">Table 7-10 Multi-level Protection Parameters Explanation</a> "
Protection recovery value	See " <a href="#">Table 7-11 Description of protection recovery parameters</a> "

\*If the country code is "China", the grid type can be set to power plant/non-power plant.

### ⚠ CAUTION

Set the grid type to correct value according to definitions of power plant scenario and non-power plant scenario. Otherwise, the inverter will run abnormally or even be damaged, and SUNGROW shall not be held liable for any damage caused.

- Power plant scenario: The inverter is applied to a power plant whose capacity is greater than 1 MW, or to a power plant that feeds power into the grid at the voltage greater than 35KV and connects to the public power grid at the voltage of 10KV.
- Non-power plant scenario: application scenarios other than the power plant scenario.

The definitions come from the national code "NB/T 32004", "GB-T19964".

Table 7-9 Single-level Protection Parameters Explanation

Parameter	Default	Range
AC under-voltage single stage protection value	110.0V	23V ~ 230V
AC over-voltage single stage protection value	276.0V	220V ~ 322V

Parameter	Default	Range
AC under-frequency single stage protection value	49.5Hz	45Hz ~ 49.89Hz
AC over-frequency single stage protection value	50.20Hz	50.11Hz ~ 55Hz

Table 7-10 Multi-level Protection Parameters Explanation

Parameter	Default	Range
AC under-voltage level one protection value	195.5V	23V ~ 230V
AC over-voltage level one protection value	253.0V	220V ~ 322V
AC under-frequency level one protection value	49.50Hz	45Hz ~ 49.89Hz
AC over-frequency level one protection value	50.20Hz	50.11Hz ~ 55Hz
AC under-voltage level one protection time	2.00s	0 ~ 600s
AC over-voltage level one protection time	2.00s	0 ~ 600s
AC under-frequency level one protection time	600s	0 ~ 600s
AC over-frequency level one protection time	120s	0 ~ 600s
AC under-voltage level two protection value	115.0V	23V ~ 230V
AC over-voltage level two protection value	310.5V	220V ~ 322V
AC under-frequency level two protection value	48.00Hz	45Hz ~ 49.89Hz
AC over-frequency level two protection value	50.50Hz	50.11Hz ~ 55Hz
AC under-voltage level two protection time	0.10s	0 ~ 600s
AC over-voltage level two protection time	0.05s	0 ~ 600s
AC under-frequency level two protection time	0.20s	0 ~ 600s
AC over-frequency level two protection time	0.20s	0 ~ 600s

Table 7-11 Description of protection recovery parameters

Parameter	Explanation
Vmax-recover	Max. protection recovery voltage
Vmin-recover	Min. protection recovery voltage
Fmax-recover	Max. protection recovery frequency
Fmin-recover	Min. protection recovery frequency

### 7.7.3 Firmware Update

#### Preparation of firmware upgrade package

Contact the supplier or SUNGROW to get the upgrade package (.sgu file) and store the package in the specified path.

- Path (Android system): root directory /iscFiles
- Storage method (iOS system): Connect the mobile phone to the computer through a data cable, find the folder iSolarCloud application via iTunes, iMazing, or iTools, and copy the upgrade package to the folder "Document".

## Upgrade

Tap "Firmware upgrade" to enter the corresponding screen, as shown in the following figure.

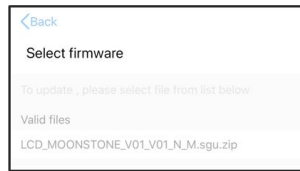

Figure 7-9 Firmware upgrade

Select the desired upgrade package to upgrade the firmware.

### 7.7.4 Feed-in Limitation (Optional)

The feed-in limitation function requires the using of Smart Energy Meter. Without the Smart Energy Meter, the feed-in limitation function will be unavailable. The function of the feed-in limitation is to control the amount of power injected in the grid by the plant. Contact SUNGROW to obtain the username and password before setting the feed-in limitation parameters.



Unauthorized personnel are not allowed to log in with this account. Otherwise, SUNGROW shall not be held liable for any damages caused.

Tap "More" -> "Advanced setting" -> "Feed-in Limitation (Zero-export)" to enter the corresponding screen.

Table 7-12 Description of feed-in limitation parameters

Parameter	Default value		Range	
	Germany	Others	Germany	Others
PV Installation Power	Rated power	-	Rated power ~ 300.00	-
Feed-in limitation	[ON]	[OFF]	[OFF]/[ON]	
Feed-in Limitation Value	PV Installation Power × 70%	Rated power	0 ~ PV Installation Power	0 ~ Rated power
Feed-in Limitation Ratio	70.0%	100.0%	0 ~ 100%	
Current transformer *	External		Built-in/ External	

Note:\* only for DTSD1352-C/10(80)A, DTSD1352-C/1 (6)A or DTSU666 Smart Energy Meter.

In case the Smart Energy Meter DTSD1352-C/10 (80) A is used, set the current transformer to "Built-in".

In case the Smart Energy Meter DTSD1352-C/1 (6)A is used, set the current transformer to "External".

When the current transformer is set to "External", set current transformer parameters according to the following ["Table 7-13 Parameter description of external current transformer"](#).

**Table 7-13** Parameter description of external current transformer

Parameter	Default value	Range
Current transformer output current	5A	-
Current transformer measuring range	200A	1 ~ 10000A



If an Smart Energy Meter equipped with external current transformer is applied, the measurement range (primary current) of the current transformer should be selected according to actual maximum current at the grid-connected point, and the maximum secondary current (output current) of the current transformer should be 5A.

The current transformer 's primary current should be equal to or greater than the maximum expected AC current from the grid, per phase. Important: The closer the expected AC current is to the chosen primary current value, the more precise the measurement will be.

## 8 System Decommissioning

### 8.1 Disconnecting the Inverter

For maintenance or other service work, the inverter must be switched off.

Proceed as follows to disconnect the inverter from the AC and DC power sources. Lethal voltages or damage to the inverter will follow if otherwise.

**Step 1** Disconnect the external AC circuit breaker and secure it against reconnection.

**Step 2** Rotate the DC switch to the “OFF” position and then disconnect all of the PV string inputs.



Skip performing step 2 when the actual device is not equipped with DC switch.

**Step 3** Wait about ten minutes until the capacitors inside the inverter completely discharge.

**Step 4** Ensure that the DC cable is current-free via a current clamp.

**Step 5** Insert a MC4 wrench into the notch and press the wrench with an appropriate force to remove the DC connector.

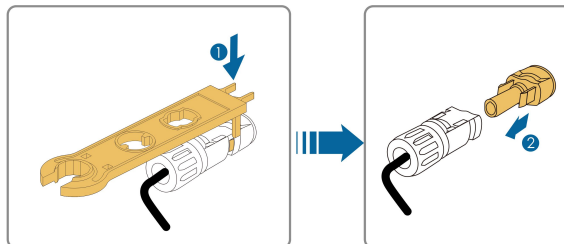

**Step 6 (Optional)** Remove the protection block with a Phillips screwdriver.

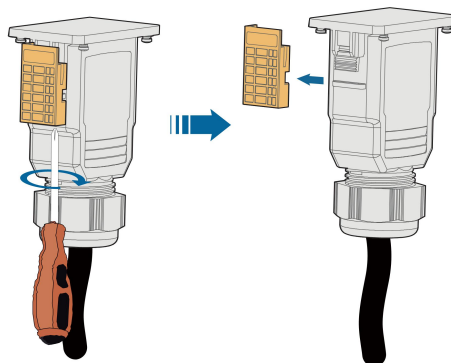

**Step 7** Lay the tool in the location of snap and press the tool down. Remove the AC connector, ensure that the AC wiring terminals are voltage-free via a multimeter, and remove the AC wires.

**Step 8** Install the MC4 waterproof plugs and AC waterproof cover.



For further disconnection and reconnection instructions, please visit the webpage of respective component manufacturer.

-- End

## 8.2 Dismantling the Inverter

### **⚠ CAUTION**

**Risk of burn injuries and electric shock!**

**Do not touch any inner live parts for 10 minutes after disconnecting the inverter from the utility grid and the PV inputs.**

**Step 1** Refer to "Electrical Connection" for the inverter disconnection of all cables in reverse steps.

**Step 2** Dismantle the inverter referring to "Mechanical Mounting" in reverse steps.

**Step 3** If necessary, remove the wall-mounting bracket from the wall.

**Step 4** If the inverter will be reinstalled in the future, please refer to "Inverter Storage" for a proper conservation.

-- End

## 8.3 Disposal of the Inverter

Users take the responsibility for the disposal of the inverter.

### **NOTICE**

Some parts and devices of the inverter, such as the capacitors, may cause environment pollution.

Do not dispose of the product together with household waste but in accordance with the disposal regulations for electronic waste applicable at the installation site.



# 9 Troubleshooting and Maintenance

## 9.1 Troubleshooting

When an alarm occurs, the alarm information can be viewed through the App.

Alarm ID and corrective measures are as follows:

Alarm ID	Description	Corrective Measures
002	Grid overvoltage The grid voltage exceeds the specified protection value.	Generally, the inverter will be reconnected to the grid after the grid recovers. If the alarm occurs frequently: <ol style="list-style-type: none"><li>1. Measure the grid voltage, and contact the local utility grid company for solutions if the grid voltage exceeds the specified value.</li><li>2. Check, through the App, whether the protection parameters are appropriately set.</li><li>3. Check whether the cross-sectional area of the AC cable meets the requirement.</li><li>4. If the alarm persists, contact SUNGROW.</li></ol>
003	Grid transient overvoltage The transient grid voltage exceeds the specified protection value.	Generally, the inverter will be reconnected to the grid after the grid recovers. If the alarm occurs frequently, contact SUNGROW.
004	Grid undervoltage The grid voltage is below the specified protection value	Generally, the inverter will be reconnected to the grid after the grid recovers. If the alarm occurs frequently: <ol style="list-style-type: none"><li>1. Measure the grid voltage, and contact the local utility grid company for solutions if the grid voltage is below the specified value.</li><li>2. Check, through the App, whether the protection parameters are appropriately set.</li><li>3. Check whether the AC cable is firmly in place.</li><li>4. If the alarm persists, contact SUNGROW.</li></ol>

Alarm ID	Description	Corrective Measures
005	Grid low voltage The grid voltage is below the specified protection value, lower than grid undervoltage	Generally, the inverter will be reconnected to the grid after the grid recovers. If the alarm occurs frequently:  1. Measure the grid voltage, and contact the local utility grid company for solutions if the grid voltage is below the specified value. 2. Check, through the App, whether the protection parameters are appropriately set. 3. Check whether the AC cable is firmly in place. 4. If the alarm persists, contact SUNGROW.
007	AC instantaneous overcurrent AC output current exceeds the upper limit of the inverter.	Generally, the inverter will be reconnected to the grid after the grid recovers. If the alarm occurs frequently, contact SUNGROW.
008	Grid overfrequency Grid frequency exceeds the upper limit of the inverter.	Generally, the inverter will be reconnected to the grid after the grid recovers. If the alarm occurs frequently:  1. Measure the grid frequency, and contact the local utility grid company for solutions if the grid frequency is beyond the specified range.
009	Grid underfrequency Grid frequency is below the lower limit of the inverter.	2. Check, through the App, whether the protection parameters are appropriately set. 3. If the alarm persists, contact SUNGROW.
010	No Grid AC switch or circuit breaker is disconnected.	Generally, the inverter will be reconnected to the grid after the grid recovers. If the alarm occurs frequently:  1. Check whether the grid supplies power reliably. 2. Check whether the AC cable is firmly in place. 3. Check whether the AC cable is correctly connected (whether the live wire and the N wire are in correct place). 4. Check whether the AC switch or circuit breaker is disconnected. 5. If the alarm persists, contact SUNGROW.

Alarm ID	Description	Corrective Measures
011	Device abnormal	<ol style="list-style-type: none"> <li>1. Wait for the inverter to recover.</li> <li>2. Disconnect the AC and DC switches or circuit breakers, and connect them again after 15 minutes.</li> <li>3. If the alarm persists, contact SUNGROW.</li> </ol>
012	Overhigh leakage current	<ol style="list-style-type: none"> <li>1. The alarm can be caused by poor sunlight or damp environment, and the inverter will be reconnected to the grid after the environment is improved.</li> <li>2. If the environment is normal, check whether the AC and DC cables are well insulated.</li> <li>3. If the alarm persists, contact SUNGROW.</li> </ol>
013	Grid abnormal The grid voltage or frequency is out of the permissible range, and therefore the inverter cannot be connected to the grid.	<p>Generally, the inverter will be reconnected to the grid after the grid recovers. If the alarm occurs frequently:</p> <ol style="list-style-type: none"> <li>1. Measure the grid frequency, and contact the local utility grid company for solutions if the grid frequency exceeds the specified value.</li> <li>2. If the alarm persists, contact SUNGROW.</li> </ol>
014	10-minute grid overvoltage The grid voltage exceeds the specified AC voltage for a long time.	<ol style="list-style-type: none"> <li>1. Wait for the inverter to recover.</li> <li>2. If the alarm occurs frequently, contact SUNGROW.</li> </ol>
015	Grid high voltage The grid voltage exceeds the specified protection value, higher than Grid overvoltage	<p>Generally, the inverter will be reconnected to the grid after the grid recovers. If the alarm occurs frequently:</p> <ol style="list-style-type: none"> <li>1. Measure the grid voltage, and contact the local utility grid company for solutions if the grid voltage exceeds the specified value.</li> <li>2. Check, through the App, whether the protection parameters are appropriately set.</li> <li>3. If the alarm persists, contact SUNGROW.</li> </ol>

Alarm ID	Description	Corrective Measures
016	Output overload The PV modules power is extremely large and out of the normal operation range of the inverter.	<ol style="list-style-type: none"> <li>1. Wait for the inverter to recover.</li> <li>2. If the alarm persists, contact SUNGROW.</li> </ol>
017	Grid voltage unbalance Unbalanced three-phase grid voltage is detected.	<p>Generally, the inverter will be reconnected to the grid after the grid recovers. If the alarm occurs frequently:</p> <ol style="list-style-type: none"> <li>1. Measure the grid voltage. If grid phase voltage differs greatly, contact the utility grid company for solutions.</li> <li>2. If the voltage difference between the three phases is within the permissible range of the local utility grid company, modify the parameter setting through the App.</li> <li>3. If the alarm persists, contact SUNGROW.</li> </ol>
019-022 024-025 030-034	Device abnormal	<ol style="list-style-type: none"> <li>1. Wait for the inverter to recover.</li> <li>2. Disconnect the AC and DC switches or circuit breakers, and connect them again after 15 minutes.</li> <li>3. If the alarm persists, contact SUNGROW.</li> </ol>
036	Overtemperature The temperature inside the inverter is extremely high and out of the permissible range.	<ol style="list-style-type: none"> <li>1. Check whether the inverter is directly exposed to sunlight. If so, take some shading measures.</li> <li>2. Check and clean the air ducts.</li> <li>3. Check whether the alarm 070 (fan alarm) occurs through the App. If so, replace the faulty fan.</li> </ol>
037	High ambient temperature The ambient temperature is extremely high and out of the permissible range.	<ol style="list-style-type: none"> <li>1. Check whether the inverter is directly exposed to sunlight. If so, take some shading measures.</li> <li>2. Check and clean the air ducts.</li> <li>3. Check whether the alarm 070 (fan alarm) occurs through the App. If so, replace the faulty fan.</li> </ol>

Alarm ID	Description	Corrective Measures
038	Device abnormal	<ol style="list-style-type: none"> <li>1. Wait for the inverter to recover.</li> <li>2. Disconnect the AC and DC switches or circuit breakers, and connect them again after 15 minutes.</li> <li>3. If the alarm persists, contact SUNGROW.</li> </ol>
039	<p>Low ISO resistance</p> <p>The alarm is generally caused by poor insulation to ground from the PV module/cable or by rainy and damp environment.</p>	<p>Wait for the inverter to recover. If the fault occurs frequently:</p> <ol style="list-style-type: none"> <li>1. Check whether the insulation resistance protection value is extremely large through the App, and ensure that it complies with the local regulations.</li> <li>2. Check the resistance to ground from the PV module/cable. Take corrective measures in case of leading to short circuit or damaged insulation layer.</li> <li>3. If the cable is normal and the alarm occurs on rainy days, check it again when the weather turns fine.</li> <li>4. If the alarm persists, contact SUNGROW.</li> </ol>
040-042	Device abnormal	<ol style="list-style-type: none"> <li>1. Wait for the inverter to recover.</li> <li>2. Disconnect the AC and DC switches or circuit, and connect them after 15 minutes.</li> <li>3. If the alarm persists, contact SUNGROW.</li> </ol>
043	<p>Low ambient temperature</p> <p>The ambient temperature is below the normal operation temperature of the inverter.</p>	<p>Stop and disconnect the inverter. Restart the inverter when the ambient temperature is within the permissible range.</p>
044-046	Device abnormal	<ol style="list-style-type: none"> <li>1. Wait for the inverter to recover.</li> <li>2. Disconnect the AC and DC switches or circuit, and connect them after 15 minutes.</li> <li>3. If the alarm persists, contact SUNGROW.</li> </ol>
047	<p>PV input s error</p> <p>The PV inputs order is incorrect.</p>	<p>Stop and disconnect the inverter. Reset the PV inputs order.</p>

Alarm ID	Description	Corrective Measures
048-050	Device abnormal	1. Wait for the inverter to recover.
053-056		2. Disconnect the AC and DC switches or circuit, and connect them after 15 minutes.
059-060		3. If the alarm persists, contact SUNGROW.
070	Fan alarm	1. Check whether the fan operates normally and whether it is blocked. If so, clean it. 2. If a fan does not operate normally, stop and disconnect the inverter to replace the fan.
071	SPD alarm (AC)	Check the SPD, and replace it or the whole inverter if necessary.
072	SPD alarm (DC)	
076	Device abnormal	1. Wait for the inverter to recover. 2. Disconnect the AC and DC switches or circuit breakers, and connect them again after 15 minutes. 3. If the alarm persists, contact SUNGROW.
078-079	PV string abnormal	1. Check if the corresponding PV string needs to be connected first. If not, ignore the alarm. If so, check whether it is connected reliably. 2. Check if the DC fuse, if necessary, belonging to the PV string is damaged. If so, replace the fuse. 3. If the alarm persists, contact SUNGROW. *The alarm ID 078 and ID 079 are corresponding to PV 1 to PV 2 respectively.
087	AFCI abnormal: Arc fault detection module abnormal	The inverter can operate normally. 1. Check whether the related cable connection and terminals are abnormal, and check whether the ambient environment is abnormal. If so, take corrective measures. 2. If the alarm persists, contact SUNGROW.

Alarm ID	Description	Corrective Measures
088	Arc fault	<ol style="list-style-type: none"> <li>1. Disconnect the DC inputs and check whether DC cables are damaged, whether the wiring terminals or fuses, if necessary, are loose or in poor contact, and whether there is PV module burnt. If so, take corresponding corrective measures.</li> <li>2. After taking corresponding measures in step 1, reconnect the DC inputs. Remove the arc fault through the App, and therefore the inverter will recover.</li> <li>3. If the alarm persists, contact SUNGROW.</li> </ol>
089	AFCI function disabled	<ol style="list-style-type: none"> <li>1. Enable the AFCI function through the App, and therefore the inverter will recover.</li> <li>2. If the alarm persists, contact SUNGROW.</li> </ol>
105	Gird protection self-check failure	<ol style="list-style-type: none"> <li>1. Restart the inverter or remove the fault through the App.</li> <li>2. If the alarm persists, contact SUNGROW.</li> </ol>
106	Grounding cable fault	<ol style="list-style-type: none"> <li>1. Check whether the AC cable is correctly connected.</li> <li>2. Check whether the grounding cable and wire cores are wrongly insulated.</li> <li>3. If the alarm persists, contact SUNGROW.</li> </ol>
116-117	Device abnormal	<ol style="list-style-type: none"> <li>1. Wait for the inverter to recover.</li> <li>2. Disconnect the AC and DC switches or circuit breakers, and connect them again after 15 minutes.</li> <li>3. If the alarm persists, contact SUNGROW.</li> </ol>
514	Smart Energy Meter communication error	<ol style="list-style-type: none"> <li>1. Check whether the Smart Energy Meter communication cable and terminal are abnormal. If so, remove the corresponding abnormality.</li> <li>2. Reconnect the Smart Energy Meterr communication cable.</li> <li>3. If the alarm persists, contact SUNGROW.</li> </ol>

Alarm ID	Description	Corrective Measures
532-535	String x reverse connection	<ol style="list-style-type: none"> <li>1. Check whether the corresponding string is of reverse polarity. If so, disconnect the DC switch and adjust the polarity when the solar radiation is low and the string current drops below 0.5A.</li> <li>2. If the fault persists, contact SUNGROW.</li> </ol> <p>*The ID 532 to ID 535 is corresponding to string 1 to string 4 respectively.</p>
548-551	Abnormal PV string current	<ol style="list-style-type: none"> <li>1. Check whether there is PV module shaded. If so, remove the shade and ensure the PV module is clean.</li> <li>2. Check the whether the PV module is in abnormal aging.</li> <li>3. If the alarm persists, contact SUNGROW.</li> </ol> <p>*The alarm ID 548 to ID 551 is corresponding to string 1 to string 4, if necessary, respectively.</p>

## 9.2 Maintenance

### DANGER

Risk of inverter damage or personal injury due to incorrect service!

Always keep in mind that the inverter is powered by dual sources: PV strings and utility grid.

Before any service work, observe the following procedure.

- Disconnect the AC circuit breaker and then set the DC load-break switch of the inverter to OFF;
- Wait at least 10 minutes for inner capacitors to discharge completely;
- Verify that there is no voltage or current before pulling any connector.

### CAUTION

Keep non-related persons away!

A temporary warning sign or barrier must be posted to keep non-related persons away while performing electrical connection and service work.



**NOTICE**

- Restart the inverter only after removing the fault that impairs safety performance.
- As the inverter contains no component parts that can be maintained, never arbitrarily replace any internal components.
- For any maintenance need, please contact SUNGROW. Otherwise, SUNGROW shall not be held liable for any damage caused.

Item	Method	Period
System clean	Check the temperature and dust of the inverter. Clean the inverter enclosure if necessary. Check if the air inlet and outlet are normal. Clean the air inlet and outlet, if necessary.	Six months to a year (- depend on the dust contents in air.)

# 10 Appendix

## 10.1 Technical Data

Parameters	SG5KTL-MT	SG6KTL-MT	SG8KTL-M
<b>Input (DC)</b>			
Max. PV input voltage		1100 V	
Min. PV input voltage / Startup input voltage		200 V / 250 V	
Nominal input voltage		600 V	
MPP voltage range		200 ~ 1000 V	
MPP voltage range for nominal power	240 ~ 850 V	290 ~ 850 V	380 ~ 850 V
No. of independent MPP inputs		2	
Max. number of PV strings per MPPT		1	
Max. PV input current		22 A ( 11 A / 11 A )	
Max. current for input connector		15 A	
Max. DC short-circuit current		30 A ( 15 A / 15 A )	
Max. inverter backfeed current to the array		0 A	
<b>Output (AC)</b>			
AC output power	5500 W @ 35 °C / 5000 W @ 45 °C	6600 W @ 35 °C / 6000 W @ 45 °C	8800 W @ 35 °C / 8000 W @ 45 °C
Max. AC output current	8.5 A	10.0 A	13.3 A
Nominal AC voltage		3 / N / PE, 230 / 400 V	
AC voltage range		270 ~ 480 V	
Nominal grid frequency		50 Hz / 60 Hz	
Grid frequency range		45 ~ 55 Hz / 55 ~ 65 Hz	
THD		< 3 % (at nominal power)	
DC current injection		< 0.5% I <sub>n</sub>	

Parameters	SG5KTL-MT	SG6KTL-MT	SG8KTL-M
Power factor at nominal power		> 0.99	
Adjustable power factor		0.8 leading ~ 0.8 lagging	
Feed-in phases / Connection phases		3/3	
<b>Efficiency</b>			
Max. efficiency	98.40%	98.40%	98.60%
Euro. efficiency	97.60%	97.70%	98.00%
<b>Protection</b>			
LVRT		Yes	
Islanding protection		Yes	
DC reverse connection protection		Yes	
AC short-circuit protection		Yes	
Leakage current protection		Yes	
Grid monitoring		Yes	
DC switch/AC switch		Yes / No	
PV string current monitoring		Yes	
PID recovery function		Optional	
Overvoltage protection		DC Type II / AC Type II	
<b>General Data</b>			
Dimensions (W x H x D)		370 × 485 × 160 mm	
Weight		20 kg	
Isolation method		Transformerless	
Degree of protection		IP65	
Night power consumption*		< 1 W	
Operating ambient temperature range		-25 ~ + 60 °C (> 45 °C derating)	
Allowable relative humidity range (non-condensing)		0 ~100 %	
Cooling method		Natural cooling	
Max. operating altitude		4000 m (> 3000 m derating)	

Parameters	SG5KTL-MT	SG6KTL-MT	SG8KTL-M
Display	LED, Bluetooth , App		
Communication	RS485 (WiFi, E-Net optional)		
DC connection type	MC4 (Max. 6 mm <sup>2</sup> )		
AC connection type	Plug and play connector (Max. 10 mm <sup>2</sup> )		

\* Devices without PID recovery function and AC power supply.

Parameters	SG10KTL-M	SG12KTL-M
<b>Input (DC)</b>		
Max. PV input voltage	1100 V	
Min. PV input voltage / Startup input voltage	200 V / 250 V	
Nominal input voltage	600 V	
MPP voltage range	200 ~ 1000 V	
MPP voltage range for nominal power	470 ~ 850 V	550 ~ 850 V
No. of independent MPP inputs	2	
Max. number of PV strings per MPPT	1	
Max. PV input current	22A ( 11A / 11 A )	
Max. current for input connector	15 A	
Max. DC short-circuit current	30 A ( 15 A / 15 A )	
Max. inverter backfeed current to the array	0 A	
<b>Output (AC)</b>		
AC output power	10000VA*/11000 VA @35 °C/ 10000 VA @ 45 °C	13200VA @ 35 °C/12000 VA @ 45 °C
Max. AC output current	16.5 A	20 A
Nominal AC voltage	3 / N / PE, 230 / 400 V	
AC voltage range	270 ~480 V	
Nominal grid frequency	50 Hz / 60 Hz	
Grid frequency range	45 ~ 55 Hz / 55 ~ 65 Hz	

Parameters	SG10KTL-M	SG12KTL-M
THD	< 3 % (at nominal power)	
DC current injection	< 0.5% I <sub>n</sub>	
Power factor at nominal power	> 0.99	
Adjustable power factor	0.8 leading ~ 0.8 lagging	
Feed-in phases / Connection phases	3 / 3	
<b>Efficiency</b>		
Max. efficiency	98.60%	
Euro. efficiency	98.10%	
<b>Protection</b>		
LVRT	Yes	
Islanding protection	Yes	
DC reverse connection protection	Yes	
AC short-circuit protection	Yes	
Leakage current protection	Yes	
Grid monitoring	Yes	
DC switch/AC switch	Yes / No	
PV string current monitoring	Yes	
PID recovery function	Optional	
Overvoltage protection	DC Type II / AC Type II	
<b>General Data</b>		
Dimensions (W x H x D)	370 × 485 × 160mm	
Weight	20 kg	
Isolation method	Transformerless	
Degree of protection	IP65	
Night power consumption**	< 1 W	
Operating ambient temperature range	-25 ~ + 60 °C (> 45 °C derating)	

Parameters	SG10KTL-M	SG12KTL-M
Allowable relative humidity range (non-condensing)	0 ~ 100 %	
Cooling method	Natural cooling	
Max. operating altitude	4000 m (> 3000 m derating)	
Display	LED, Bluetooth , App	
Communication	RS485 (WiFi, E-Net optional)	
DC connection type	MC4 (Max. 6 mm <sup>2</sup> )	
AC connection type	Plug and play connector (Max. 10 mm <sup>2</sup> )	

\* Applicable to German.

\*\* Devices without PID recovery function and AC power supply.

## 10.2 Quality Assurance

When product faults occur during the warranty period, SUNGROW will provide free service or replace the product with a new one.

### Evidence

During the warranty period, the customer shall provide the product purchase invoice and date. In addition, the trademark on the product shall be undamaged and legible. Otherwise, SUNGROW has the right to refuse to honor the quality guarantee.

### Conditions

- After replacement, unqualified products shall be processed by SUNGROW.
- The customer shall give SUNGROW a reasonable period to repair the faulty device.

### Exclusion of Liability

In the following circumstances, SUNGROW has the right to refuse to honor the quality guarantee:

- The free warranty period for the whole machine/components has expired.
- The device is damaged during transport.
- The device is incorrectly installed, refitted, or used.
- The device operates in harsh environment, as described in this manual.
- The fault or damage is caused by installation, repairs, modification, or disassembly performed by a service provider or personnel not from SUNGROW.
- The fault or damage is caused by the use of non-standard or non-SUNGROW components or software.
- The installation and use range are beyond stipulations of relevant international standards.

- The damage is caused by unexpected natural factors.

For faulty products in any of above cases, if the customer requests maintenance, paid maintenance service may be provided based on the judgment of SUNGROW.

## 10.3 Contact Information

Should you have any question about this product, please contact us.

We need the following information to provide you the best assistance:

- Type of the device
- Serial number of the device
- Fault code/name
- Brief description of the problem

### China (HQ)

Sungrow Power Supply Co., Ltd  
Hefei  
+86 551 65327834  
[service@sungrowpower.com](mailto:service@sungrowpower.com)

### Australia

Sungrow Australia Group Pty. Ltd.  
Sydney  
+61 2 9922 1522  
[service@sungrowpower.com.au](mailto:service@sungrowpower.com.au)

### Brazil

Sungrow Do Brasil  
Sao Paulo  
+55 11 2366 1957  
[latam.service@sa.sungrowpower.com](mailto:latam.service@sa.sungrowpower.com)

### France

Sungrow France  
Lyon  
+33420102107  
[service@sungrow-emea.com](mailto:service@sungrow-emea.com)

### Germany, Austria, Switzerland

Sungrow Deutschland GmbH  
Munich  
+49 0800 4327 9289  
[service@sungrow-emea.com](mailto:service@sungrow-emea.com)

### Greece

Service Partner – Survey Digital  
+30 2106044212  
[service@sungrow-emea.com](mailto:service@sungrow-emea.com)

### India

Sungrow (India) Private Limited  
Gurgaon  
+91 080 41201350  
[service@in.sungrowpower.com](mailto:service@in.sungrowpower.com)

### Italy

Sungrow Italy  
Verona  
+39 0800 974739 (Residential)  
+39 045 4752117 (Others)  
[service@sungrow-emea.com](mailto:service@sungrow-emea.com)

<p><b>Japan</b></p> <p>Sungrow Japan K.K. Tokyo + 81 3 6262 9917 <a href="mailto:service@jp.sungrowpower.com">service@jp.sungrowpower.com</a></p>	<p><b>Korea</b></p> <p>Sungrow Power Korea Limited Seoul +82 70 7719 1889 <a href="mailto:service@kr.sungrowpower.com">service@kr.sungrowpower.com</a></p>
<p><b>Malaysia</b></p> <p>Sungrow SEA Selangor Darul Ehsan +60 19 897 3360 <a href="mailto:service@my.sungrowpower.com">service@my.sungrowpower.com</a></p>	<p><b>Philippines</b></p> <p>Sungrow Power Supply Co., Ltd Mandaluyong City +63 91 73022769 <a href="mailto:service@ph.sungrowpower.com">service@ph.sungrowpower.com</a></p>
<p><b>Thailand</b></p> <p>Sungrow Thailand Co., Ltd. Bangkok +66 891246053 <a href="mailto:service@th.sungrowpower.com">service@th.sungrowpower.com</a></p>	<p><b>Spain</b></p> <p>Sungrow Ib é rica S.A.U. Mutilva +34 948 05 22 04 <a href="mailto:service@sungrow-emea.com">service@sungrow-emea.com</a></p>
<p><b>Romania</b></p> <p>Service Partner - Elerex +40 241 762250 <a href="mailto:service@sungrow-emea.com">service@sungrow-emea.com</a></p>	<p><b>Turkey</b></p> <p>Sungrow Deutschland GmbH Turkey Istanbul +90 216 663 61 80 <a href="mailto:service@sungrow-emea.com">service@sungrow-emea.com</a></p>
<p><b>UK</b></p> <p>Sungrow Power UK Ltd. Milton Keynes +44 (0) 01908 414127 <a href="mailto:service@sungrow-emea.com">service@sungrow-emea.com</a></p>	<p><b>U.S.A, Mexico</b></p> <p>Sungrow USA Corporation Phoenix +1 833 747 6937 <a href="mailto:techsupport@sungrow-na.com">techsupport@sungrow-na.com</a></p>
<p><b>Vietnam</b></p> <p>Sungrow Vietnam Hanoi +84 918 402 140 <a href="mailto:service@vn.sungrowpower.com">service@vn.sungrowpower.com</a></p>	<p><b>Belgium, Netherlands and Luxembourg (Benelus)</b></p> <p>Service (only NL): +31 08000227012 <a href="mailto:service@sungrow-emea.com">service@sungrow-emea.com</a></p>
<p><b>Poland</b></p> <p>+48 221530484 <a href="mailto:service@sungrow-emea.com">service@sungrow-emea.com</a></p>	-