

**You want to
change the world?**
Seems like you should
get to know us!



We are a green tech company unlike any other green tech company. We are a team of lateral thinkers, young professionals and creative minds.

We are **Sungrow**.
We are changing the world.
Clean Power For All!



Jeremy Powell
Director Distribution
Sungrow Europe



With our “Yes we can” attitude we make the impossible happen. We are fast and powerful, this is our Chinese DNA. We have a massive R&D task force to **push innovation and develop the most intuitive and persuasive products** of the whole industry. In our European team we count on

motivated talents. We aim for **new perspectives**, to **do things differently**, and to **make photovoltaics fun**. With our powerful roots in China and the continuous striving for more of our European team, we are unstoppable. We will accomplish our mission: **Clean Power For All – It’s a promise!**

Solar farm near Hefei, China:
Step by step into a clean future -
SG250HX inverters in action.

+182 GIGAWATT

You want to revolutionize the energy market, but are **still looking for the perfect match**? No worries, we got you covered!

With more than 182 gigawatts shipped, Sungrow is the global leading inverter solution supplier for renewables and the first inverter company ever to hit this particular record.

We are proud to look back to a success story that already began in 1997, but we never stopped striving for more. We want to give **fresh impulses**,

inspire and contribute to a sustainable development of our planet, that's why we constantly improve our portfolio. From floating solar plants to large-scale utility projects and to small residential products we always offer the best and most suitable solution for you.

Simply said, we are the partner for all – who want more.

Founded in 1997, Sungrow has become the world's leading inverter supplier with + \$ 2.9 billion revenue in 2020.

100%

BANKABLE

Hard work pays off – Sungrow has been ranked to be **the most bankable inverter brand** by BloombergNEF.

The survey highlights the **creditworthiness and reliability** of partnering with Sungrow considering comprehensive dimensions of evaluation, in particular, long-term warranties and insurance, local support and superior product quality. Notably, Sungrow has an **industry-leading**

testing centre certified by all major international certification bodies including TÜV Rheinland, TÜV SÜD, CSA, UL and CNAS.

Sungrow inverters have passed over **one thousand independent quality and reliability tests**, a feat unmatched by the majority of inverter manufacturers.

Biggest existing solar farm in Benelux:

Engie Fabricon realized the 100 MW solar park in Belgium with the most reliable solution - Sungrow inverters.

Bloomberg's test criteria



Reliability of warranties and insurance



Availability of local support



Product quality

+40% R&D

WORKFORCE

How did Sungrow become the global leading inverter supplier? **We focused on what we are good at!**

Sungrow was founded back in 1997 by Prof Cao Renxian – a professor at the Hefei University of Technology.

Along the way of growth, we always stick to the roots of our founder – being innovative and never stop learning. Most of our product developers come directly from the university, **they think big and want to make the impossible happen.** You will rediscover this spirit in our products!

At Sungrow **we hold more than 1500 patents** – no wonder as we employ the **biggest research and development team of the whole industry.** 40% of all Sungrow workforce is continuously investigating on how to further improve the existing portfolio – for you.

Joining one of the biggest inverter suppliers directly after university? Yes, that's exactly what we want! A fresh spirit and creative thinking are the key drivers to find innovative solutions and develop the best products. David Li, Product Developer for Residential products summarizes our corporate culture very well: *"I love the spirit at Sungrow. Extraordinary ideas are always encouraged, even if you're only an intern like I was, when I started my career at this unique company."*



Sungrow Headquarter Hefei, China:
Biggest EMC chamber in the solar industry

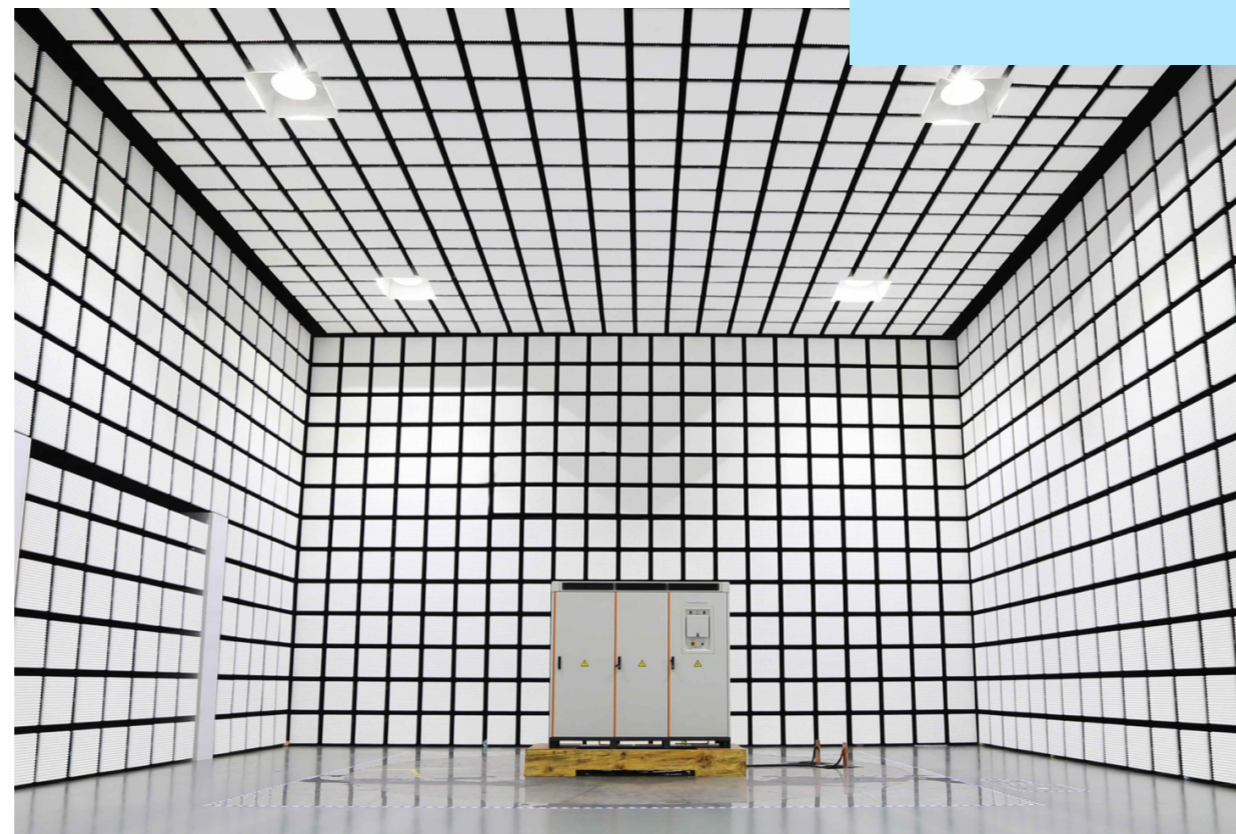

Extraordinary ideas are always encouraged.



David Li
R&D Engineer for Residential Products

INNOVATIVE & FAST - THAT'S US!

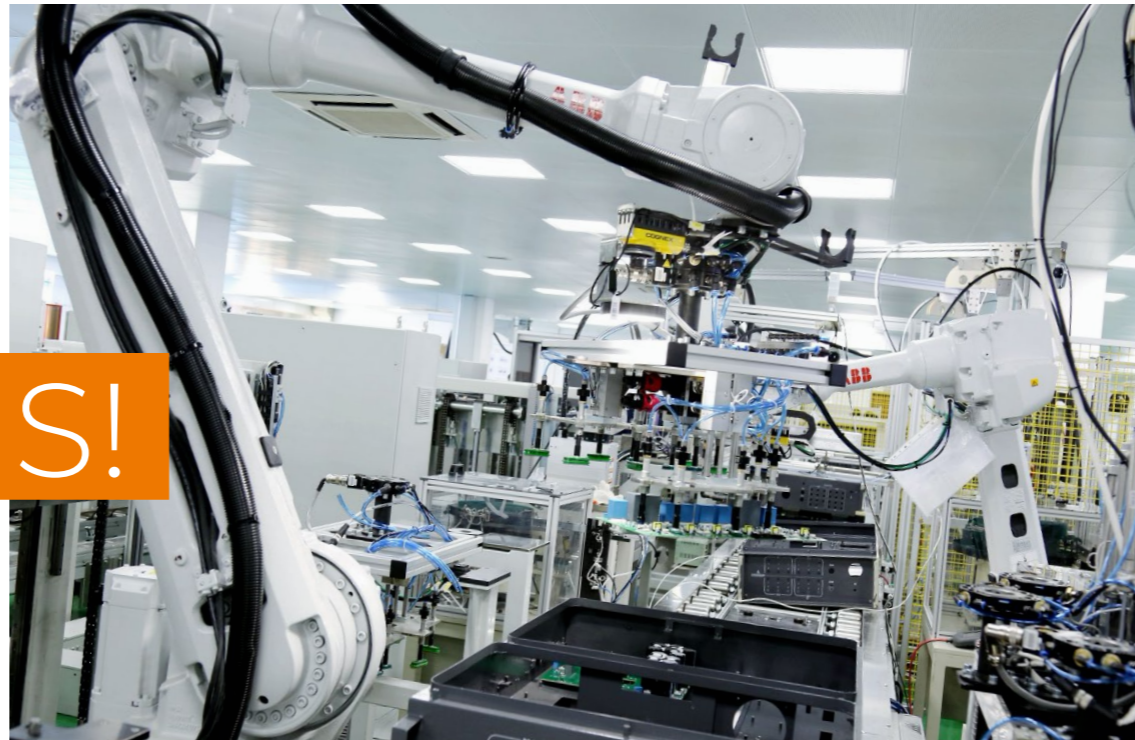

Hefei, China:
Sungrow's newly opened production site

We always strive for more – the highest standards, the most innovative products, the best availability. So you won't have anything to worry about!

Our new production site in Hefei opened its doors end of 2018. The area encompasses more than 300,000 m² and has been **built according to the latest technological standards.** All products Residential, Commercial, Utility and even Floating Systems are being produced there. The **annual production capacity of Sungrow amounts to 90 GW.**

And of course we never lose sight of our big picture – Clean Power For All. That's why we installed a nearly 11 MW solar system on the roofs of our production site and all offices in Hefei. Like this we are able to reduce carbon

dioxide emissions by approximately 11,000 tons every year.

**You want more?
So do we!**

We can scale our production up to 1000 inverters per shift, with three shifts per day.

But what's the point of thousands of inverters, as long as they are in China? No worries, we've thought about that as well. That's why we have our **large-scale warehouse in Europe.**

This enables us to ensure short term deliveries and make sure that you will get your product whenever you need it.

35 working days from production to distributor? Yes, we can!

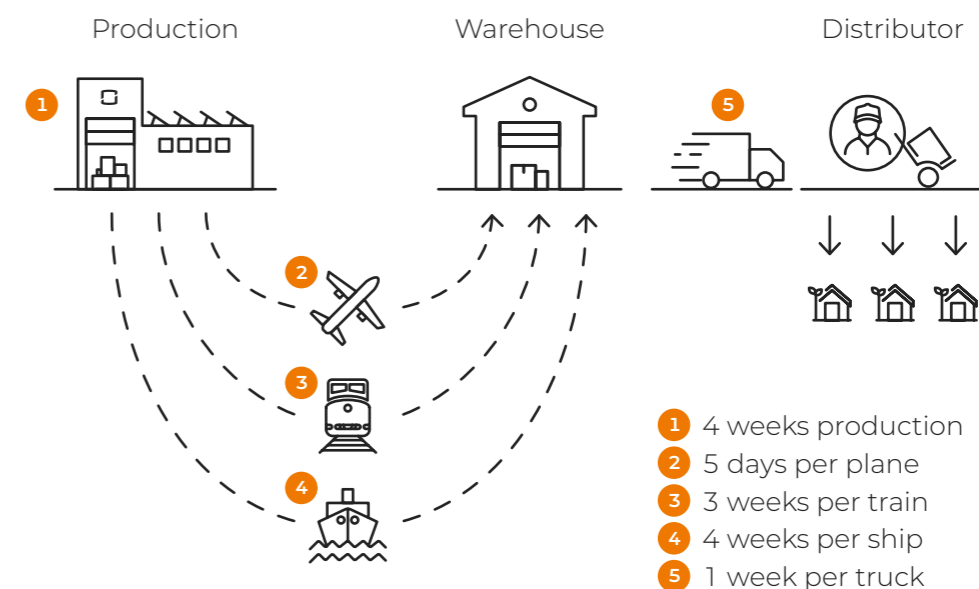

10 YEARS WARRANTY

FEAR OF BREAKDOWN?
NO WORRIES, **WE GOT
YOU COVERED!**

It's time to think bigger – that's why we **extended our warranty to 10 years** for all inverters from **2,5 kW to 20 kW** in Europe. The best thing about it? It's free and valid retroactively **for all products purchased since 01.01.2020.**

With more than two decades of experience, Sungrow stands for quality and consistency. **Only the best is good enough for our products.** Even if you can't see them – it's the inner values that count. We team up with the best and benefit from long lasting partnerships with industry leaders like Infineon, NMB and many more.

For your **carefree start** into a clean future.



RESIDENTIAL HEROES

For all.
Who want more.



The 1-Phase Hybrid

3–6 kW

The Pioneer

The 1-phase hybrid inverter has proven its functionality and quality since 2015. The new generation offers seamless transition to backup mode, PID Recovery and is still light and easy to install - innovation at its best.

SH3.0RS, SH3.6RS, SH4.0RS, SH5.0RS, SH6.0RS

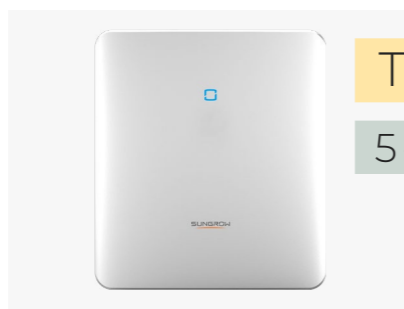

The 3-Phase Hybrid

5–10 kW

The Futurist

The 3-phase hybrid is ready for the future: smart energy management, emergency power function, SG-Ready interface and unique in its fast installation - what else you could wish for?

SH5.0RT, SH6.0RT, SH8.0RT, SH10RT



The 1-Phase

2–6 kW

The Original

The 1-phase inverter - original since its launch. The display and the push - click - go connector make this product as easy as possible to handle. The perfect solution for houses with limited rooftop size.

SG2.0RS-S, SG2.5RS-S, SG3.0RS-S, SG3.0RS, SG3.6RS, SG4.0RS, SG5.0RS, SG6.0RS



The 3-Phase

3–20 kW

The Advanced

More power, more functions, less needed space. Compared to its functions the 3-phase PV inverter is very compact and easy to install. The perfect solution for bigger rooftops.

SG3.0RT*, SG4.0RT*, SG5.0RT, SG6.0RT, SG7.0RT, SG8.0RT, SG10RT, SG12RT, SG15RT, SG17RT, SG20RT (* will only be available in Poland)

DETAILS THAT MATTER

Everybody knows them, these days when you have the feeling that you can't manage all the tasks that sum up on your to-do list.

No worries, with Sungrow inverters you will easily manage all of them. All our products are designed and developed to **make your life as easy as possible**.

Smart.

iSolarCloud – Guided off-line commissioning and free monitoring wherever you are.

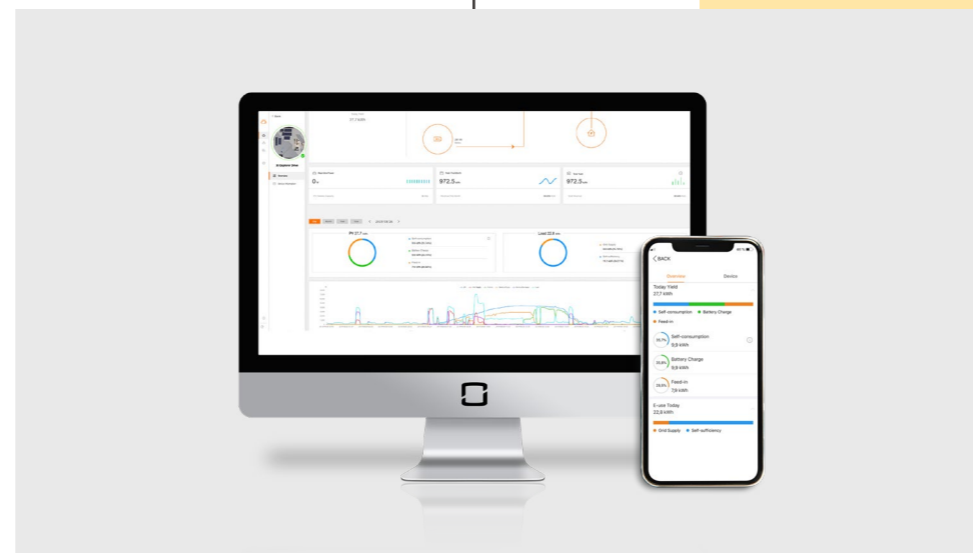

Easy.

The unique **Push - Click - Go connectors** make the installation as convenient as never before.



Fast.

No need to open the inverter, resulting in a **less time consuming installation**.



Fun.

Mounting the inverter on the wall with an **integrated water level**. Always in balance, making a good impression.

THE NEXT BIG THING



Certified with the most updated safety standards like the strict VDE2510-50.

SUNGROW'S RESIDENTIAL BATTERY - BEYOND THE EXPECTED!

The new Residential Battery is **compatible with the 1-phase and 3-phase Hybrid from Sungrow**. Together, they form the carefree solution of the market, with **10 years warranty**. The high voltage design and peak current **output enable higher self-consumption and backup performance**.



Beyond flexible

From 3 to 8 modules per battery: Like this you can scale capacity from 9.6 kWh up to 25.6 kWh.

Beyond effortless

Light weight and practical design: Light weight and practical design: With only 33 kg per module and comfortable handles, the installation can easily be realized by one person.



Beyond easy

Time saving at its best: No wiring between the individual modules required. Simple plug & play.



HEROES

EXTREME

High power but less installation effort?
Yes we can!



Commercial Extreme

36.3 – 55 kW

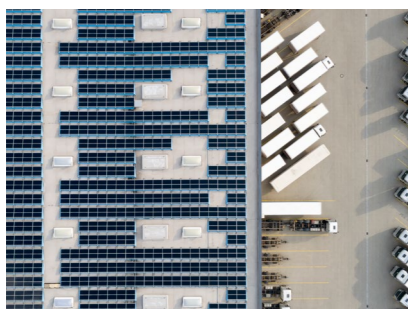

Commercial Extreme

110 kW

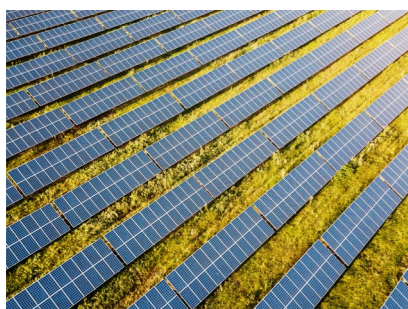

High Extreme

250 kW



Sungrow in a few words? Innovative, reliable and always by our side.



André Rosenbusch
Project manager
Medium voltage & grid
Münch Energie

The All-rounder

This inverter comes in three different performance classes. The integrated NS-protection and the patented external AC-connector make this inverter extremely easy to install and therefore unique in it's class.

SG33CX, SG40CX, SG50CX

The Powerful

The most powerful inverter of the Commercial Extreme Series - with 110 kW it's the perfect solution for big roof installations. As its smaller brother it has a smart active cooling function integrated and can be mounted almost flat on the roof.

SG110CX

The Invincible

More solar panels need more power. This 1500 V inverter is the perfect solution for your ground-mounted projects. Benefit from the space-saving design and the highest power density on the market.

SG250HX

WE OFFER MORE

More power, more features but still easy and fun to handle? Yes, that describes our series of powerful inverters quite well.

No matter if mounted on the roof or on the ground, we offer the perfect solution with smart product features to **make your life as easy as possible.**

Durable.

Smart active cooling – Durable, high-quality fans ensure the perfect operating temperature at any time. Longevity engineered.



Easy.

Patented AC-Connector – No need to open the inverter for commissioning. Solutions that stand out!

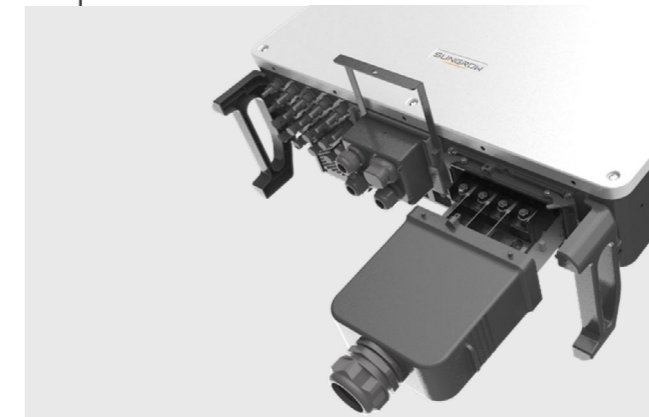

Safe.

IP66, C5 and NS-protection – Safety is our top priority. Our integrated NS-protection isn't just safe, but also saves you a lot of money.

Profitable.

DC/AC ratio up to 1.5 – Sometimes less is more. With Sungrow you need less inverters for the same amount of PV.



STAY UP TO DATE

With our communication devices and smart meters you are perfectly equipped for every scenario.



Wi-Net

The best of both worlds combined: WiFi and Ethernet in one port. Accurate and reliable data with 10 sec. refresh rate.

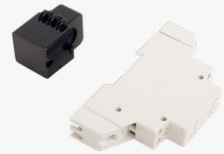

1-phase meter

More energy transparency for single phase homes. The 1-phase meter helps to optimize your consumption.



3-phase meter

Precise determination of electrical measured values. Keep track on feed-in & consumption. The 3-phase grid solution.



Com100e

Plant maintenance as simple as it can be! Easy to install, night light for maintenance & robust enclosure. Logger1000 inside.



Logger1000

The heart piece of COM100E. Supports RS485, Ethernet, WLAN communication. Built-in server for monitoring and configuration.



The 3-phase with connected Wi-Net module. One click - that's it!

FREE, SMART AND EASY TO USE

Stay tuned, no matter where you are!

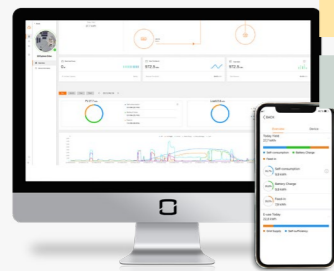
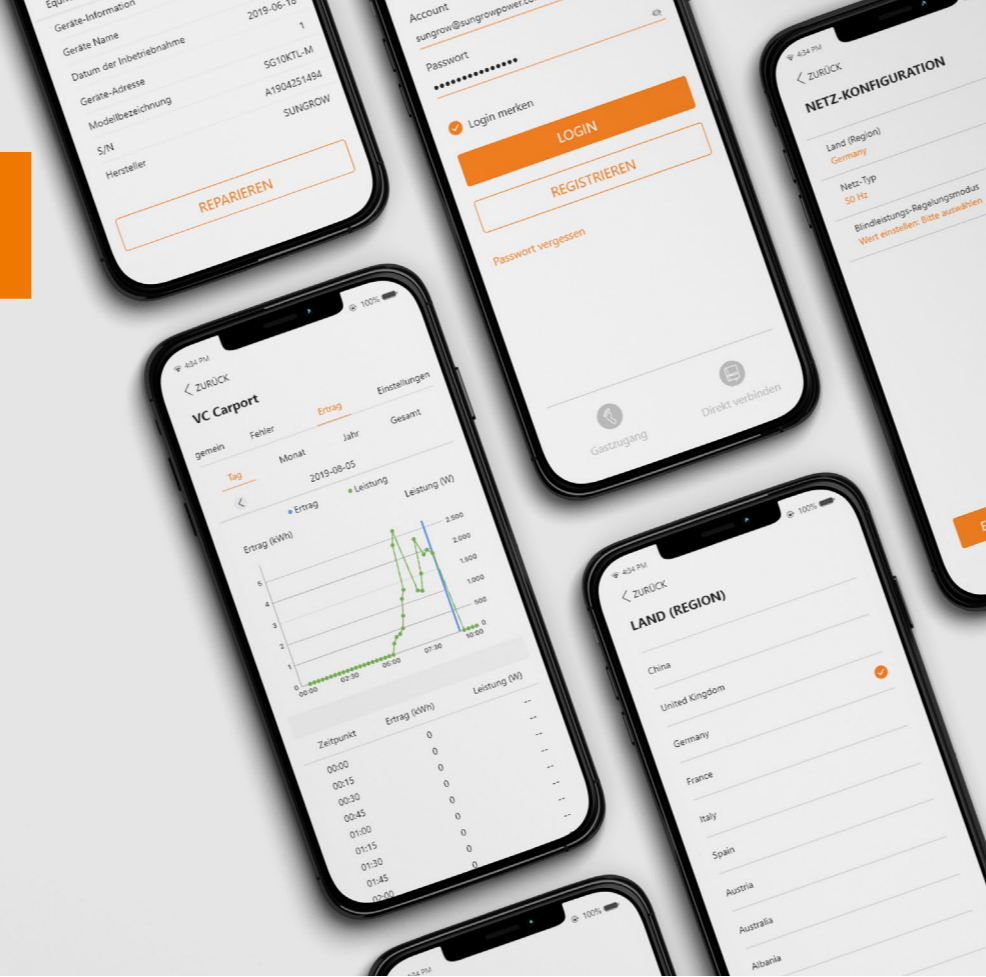

iSolarCloud

Web & App

Superior Monitoring, higher yield. Get the most out of your PV installations with our free of charge platform. No matter if App or for desktop, we care about data security. All data is stored on European servers.

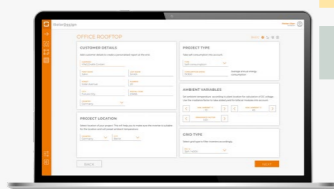

iSolarDesign

Web

The next generation of string sizing. Validate your plant design or generate a harmonics report in the blink of an eye.



iSolarCloud

Superior monitoring.
Higher yield.

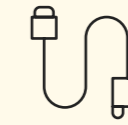

Fast

The iSolarCloud wizard guides you through commissioning in a breeze.



Safe

Your data is secured on a European server; 100% GDPR compliant.



Smart

Benefit from remote parameter setting and troubleshooting from wherever you are.



Easy

Enjoy the most user-friendly monitoring with lucid tables and automated reports.

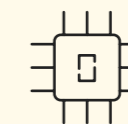

Future-proof

Be always up to speed and get new features and frequent updates.



Connected

Share your solar plants with colleagues and your family..

FLOATING, UTILITY & MORE



With more than 70 patents, we are the leading supplier for floating systems.

Upper picture: Huainan Former coal mine, China

With our floating solutions we open up completely new fields for solar parks. We built the world's largest floating PV plant which reduces Carbon Dioxide emissions by 150,000 tons every year. **We live green energy,** no matter the size or the location, it's deeply anchored in our DNA.

At **Sungrow Clean Power** is made to fit any size.

Our turn-key container solutions come with versatile application possibilities and integrated features to meet the requirements of the grid. Due to its standard design (10- or 20-foot container size), our central inverters are **easy to transport and easy to install.**

We know that the PV inverter may not be the only thing you need for your solar park – with our **Sungrow storage solutions** you will have power whenever you need it. All in all a care-free package.

SG2500 in Uden, Netherlands: Main initiative for the goal of an energy-neutral Uden. Built in 2018 this 10 MW plant provides energy for 3.500 households.





CUSTOMER CARE

Things don't stop with the product purchase. What matters most is you!

Some companies may consider **in-depth service** to be nothing but a cost factor. We like to think of it as a **welcome chance to reconnect** and build a long-lasting and mutually beneficial relationship with you.

With numerous **Sungrow service outlets** worldwide we have a massive manpower ready to

tackle all the challenges that you may face.

We built regional **spare part warehouses fully stocked** with original parts for fast delivery. We will train you in all aspects of operation, maintenance and project management required for your installation. So don't worry whatever it may be – **we are here for you!**

- 
+ 50 Service Outlets
- 
+ 35 Local Languages
- 
+ 30 Regional Warehouses

We believe in absolute **reliability, top quality** and the **long-term success** of renewable energies.

Sungrow is the perfect partner for that mission. During the past **5 years of our strong partnership**, Sungrow has more than proven that we can fully rely on their expertise and support.



Stefan Müller
COO Enerparc



WE CREATE MEMORIES

It's time to get to know each other and have some fun together!

With the **Sungrow Power Day** we want to give you the possibility to get to know us in an inspiring and fun way. A day packed with excellent conversations and great people is waiting for you.

- Product Hands-On
- R&D Experts
- Social Drinks & Snacks
- Networking
- Experience Tour

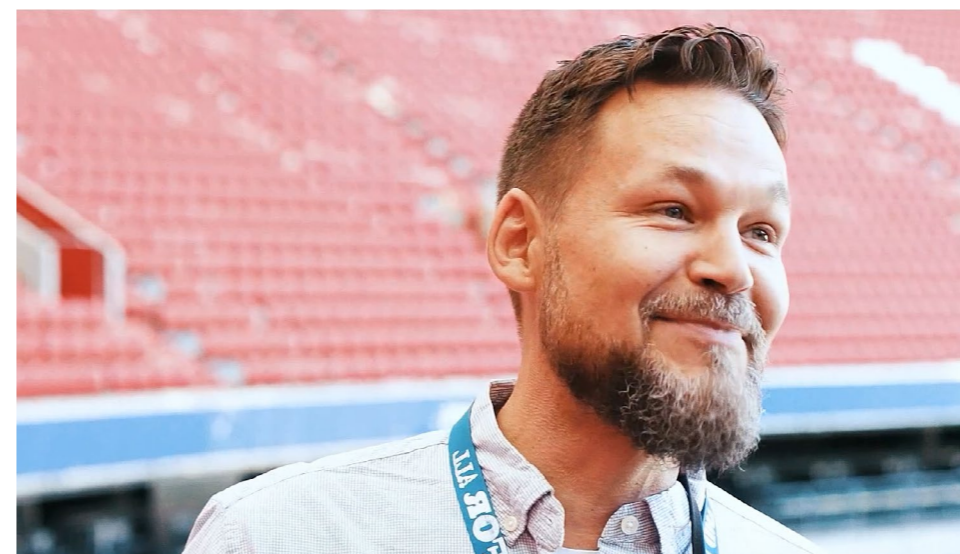

That's spectacular, outstanding!



Erasmus Lob
Founder | Lob Solar



Visit a Sungrow Power Day and become **Sungrow Power Partner**.



HOP ON BOARD AND JOIN OUR MISSION: CLEAN POWER FOR ALL

We offer the highest value for the most competitive pricing.
We work with the best.
We are ready – are you?

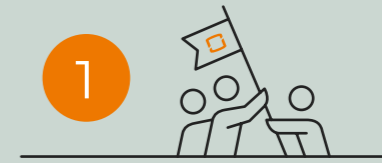

Get your personal Partner Success Manager to boost your business.



Enjoy an exciting onboarding experience and get latest industry insights.



Get access to the Sungrow Power Kit with cutting-edge info material for professionals and end users.



Experience hands-on workshops, a factory visit and Chinese culture in the Sungrow Headquarter.

36 pages of Sungrow but you still want more? **So do we!**

Let's join forces and conquer the world.

We are sure, together nobody can stop us.

We can't wait to get to know you!

Learn more on

www.sungrowpower.com