User Manual

SH3K6 / SH4K6

**Grid-Connected Hybrid
Inverter**



About This Manual

Applicability

This manual is applicable to the inverter types:

- SH3K6
- SH4K6

Target Group

This manual is intended for:

- qualified personnel who are responsible for the installation and commissioning of the inverter; and
- inverter owners who will have the ability to interact with the inverter via the LCD menu.

How to Use the Manual



Read the manual and other related documents before any work on the inverter is carried out. Documents must be stored carefully and be available at all times.



All rights to the content of this manual are owned by Sungrow Power Supply Co., Ltd. (hereinafter "SUNGROW"). No part of this document can be modified, distributed, reproduced or published in any form or by any means without prior written permission from SUNGROW.

Content may be periodically updated or revised due to product development. The information in this manual is subject to change without notice. The latest manual can be acquired at <http://support.sungrowpower.com/>.

Symbols

Safety instructions will be highlighted with the following symbols.

Symbol	Explanation
	Indicates a hazard with a high level of risk that, if not avoided, will result in death or serious injury.
	Indicates a hazard with a medium level of risk that, if not avoided, could result in death or serious injury.

Symbol	Explanation
 CAUTION	Indicates a hazard with a low level of risk that, if not avoided, could result in minor or moderate injury.
NOTICE	Indicates a situation that, if not avoided, could result in equipment or property damage.
	Indicates additional information, emphasized contents or tips that may be helpful, e.g. to help you solve problems or save time.

Contents

About This Manual	I
1 Safety.....	1
2 System Solution	6
2.1 PV Energy Storage System (PV ESS)	11
2.2 Retrofitting the Existing PV System.....	13
3 Function Description	15
3.1 Safety Function	15
3.1.1 Protection	15
3.1.2 Earth Fault Alarm.....	15
3.1.3 SPI and Auto Test (Italy only)	15
3.2 Energy Conversion and Management	16
3.2.1 Power Derating.....	16
3.2.2 Regular Operational Voltage Range	17
3.2.3 Regular Operational Frequency Range	19
3.2.4 Active Power Regulation.....	20
3.2.5 Reactive Power Regulation	21
3.2.6 Load Control.....	22
3.3 Battery Management	22
3.3.1 Charge Management.....	23
3.3.2 Discharge Management	24
3.3.3 Maintenance Management	24
3.3.4 Battery Temperature Sensor (PT1000)	25
3.4 Communication and Configuration	25
4 Unpacking and Storing.....	26
4.1 Unpacking and Inspecting	26
4.2 Delivery Contents	27
4.3 Storing the Inverter	28
5 Mechanical Mounting.....	29

5.1	Safety during Mounting	29
5.2	Location Requirements	29
5.3	Tools	31
5.4	Installing the Inverter.....	33
5.5	Grounding the Inverter	34
5.6	Installing the Energy Meter	35
6	Electrical Connection	36
6.1	Terminal Description	36
6.2	Energy Meter Connection	38
6.3	Grid Connection	41
	6.3.2 Assembling the AC Connector.....	42
	6.3.3 Installing the AC Connector	43
6.4	PV Connection	44
	6.4.1 PV Input Configuration	44
	6.4.2 Connecting the Inverter to the PV Array	45
6.5	Communication Connection.....	48
	6.5.1 Ethernet Connection	48
	6.5.2 Wi-Fi Connection.....	50
6.6	Battery Connection	51
	6.6.1 Connecting the Power Cable.....	52
	6.6.2 Connecting the CAN Cable	53
	6.6.3 Connecting the Temperature Sensor	54
6.7	DO Connection	55
7	Commissioning	58
7.1	Inspection before Commissioning	58
7.2	Button Introduction.....	58
7.3	Commissioning Procedure.....	59
7.4	Result Verification	64
	7.4.1 Energy Meter Installation and Connection	64
	7.4.2 Battery Information	66
	7.4.3 System Time	67
8	Troubleshooting and Maintenance.....	68

8.1	Troubleshooting.....	68
8.1.1	LED Indicator	68
8.1.2	Errors on the App or LCD Screen	68
8.2	Maintenance.....	77
8.2.1	Routine Maintenance	77
8.2.2	Replacing the Button Cell.....	77
9	System Decommissioning	78
9.1	Decommissioning the Inverter.....	78
9.2	Decommissioning the Battery.....	79
10	Appendix II: LCD Operation	80
10.1	Main Screen.....	80
10.2	LCD Menu Structure.....	81
10.3	Starting and Stopping the Inverter.....	83
10.4	Advanced Settings	83
10.4.1	Inputting Password.....	83
10.4.2	Adding the Existing System.....	83
10.4.3	Setting the Battery Type	84
10.4.4	Setting the Battery Usage Time.....	85
10.4.5	Setting Forced Charge	85
10.4.6	Setting the Protective Parameters.....	85
10.4.7	Setting Reactive Power Regulation	86
10.4.8	Setting Active Power Response.....	87
10.4.9	Setting Load Control.....	87
10.4.10	Setting the Communication Parameters	89
10.4.11	Testing Earth Fault.....	89
10.4.12	PT1000 Switch Setting.....	90
10.4.13	Factory Reset.....	90
10.5	Setting the Time	90
10.6	Setting the Country.....	91
10.7	Viewing the Error Codes	92
10.8	Auto Test (Italy)	92
11	Appendix IV: Power Response	96

11.1	For Countries except Italy	96
11.1.1	“Q” Mode	96
11.1.2	“Q(P)” Mode	96
11.1.3	“Q(U)” Mode	97
11.1.4	Over-frequency Response	98
11.2	For Italy (“IT”)	99
11.2.1	“Q” Mode	99
11.2.2	“Q(P)” Mode	100
11.2.3	“Q(U)” Mode	100
11.2.4	Volt-watt Response	101
11.2.5	Frq-watt Response	102
11.2.6	Interface Protection System (SPI)	103
12	Appendix V: Technical Data	107
12.1	Inverter	107
12.2	Energy Meter	109
12.3	Quality Assurance	109

1 Safety

General Safety

The inverter has been designed and tested strictly according to international safety regulations. Read all safety instructions carefully prior to any work and observe them at all times when working on or with the inverter.

Incorrect operation or work may cause:

- injury or death to the operator or a third party;
- damage to the inverter or other properties.

DANGER

Lethal voltage!

- PV strings will produce electrical power when exposed to sunlight and can cause a lethal voltage and an electric shock.
- Only qualified personnel can perform the wiring of the PV panels.

NOTICE



All electrical connections must be in accordance with local and national standards.







Only with the permission of the local utility grid company, the inverter can be connected to the utility grid.

Inverter

A warning label and a nameplate are pasted on the side of the inverter.

Tab. 1-1 Symbols on the Inverter

Symbol	Explanation
	Disconnect the inverter from all the external power sources before maintenance!
	Do not touch live parts for 10 minutes after disconnection from the power sources.

Symbol	Explanation
	Burn danger due to hot surface that may exceed 60 °C.
	Danger to life due to high voltages! Only qualified personnel can open and maintain the inverter.
	Read the user manual before maintenance!
	Do not dispose of the inverter together with household wastes.
	The inverter does not have a transformer.
	TUV mark of conformity.
	CE mark of conformity.

* The warning label in English is applied before delivery. Labels in other languages are included in the delivery scope may be applied if necessary.

DANGER

Danger to life from electric shock due to live voltage

- Do not open the enclosure when the inverter is running. Unauthorized opening will void warranty and warranty claims and in most cases terminate the operating license.
- When the enclosure lid is removed, live components can be touched which can result in death or serious injury due to electric shock.

Lethal danger from electric shock due to possibly damaged inverter

- Only operate the inverter when it is technically faultless and in a safe state.
- Operating a damaged inverter can lead to hazardous situations that can result in death or serious injuries due to electric shock.

 **WARNING****Risk of inverter damage or personal injury**

Do not disconnect PV connectors, AC connector or battery connectors while the inverter is running. De-energize from all multiple power sources. Wait 10 minutes for the internal capacitors to discharge. Verify that there is no voltage or current before disconnecting any connectors.

All the warning labels and nameplate on the inverter body:

- must be clearly visible;
- must not be removed, covered or pasted.

 **CAUTION****Risk of burns due to hot components**

Do not touch any hot parts (such as the heat sink) during operation. Only the LCD panel and the DC switch can safely be touched at any time.

NOTICE

Only qualified personnel can change the country setting. Unauthorized alteration may cause a breach of the type-certificate marking.

Risk of inverter damage due to electrostatic discharge (ESD)!

By touching the electronic components, you may damage the inverter. For inverter handling, be sure to:

- avoid any unnecessary touching; and
- wear a grounding wristband before touching any connectors.

Batteries **DANGER**

Batteries deliver electric power, resulting in burns or a fire hazard when they are short circuited, or wrongly installed.

Lethal voltages are present at the battery terminals and cables connecting to the inverter. Severe injuries or death may occur if the cables and terminals in the inverter are touched.

⚠ WARNING

Provide sufficient ventilation for lead-acid battery systems to prevent flames and sparks from the explosive hydrogen gas that the batteries release.

Due to the dangers of hydrogen gas and battery electrolyte:

- locate batteries in a designated area, complying with the local regulations;
- protect the enclosure against destruction;
- do not open or deform the battery module;
- whenever working on the battery, wear suitable personal protective equipment (PPE) such as rubber gloves, rubber boots and goggles;
- rinse acid splashes thoroughly with clear water for a long time and consider consulting a doctor.

NOTICE

Improper settings or maintenance can permanently damage the battery.

Incorrect inverter parameters will lead to the premature aging of battery.

Energy Meter**⚠ DANGER**

Lethal voltages and danger to life due to electric shock!

- Only use the Energy Meter in a dry environment and keep it away from liquids.
- Install the Energy Meter in the switch cabinet only and ensure that the connection areas for the line and the neutral conductors are behind an insulting cover or have contact protection.
- Install an external disconnect switch between the Energy Meter and the grid-connected point. The external disconnect must be close to the Energy Meter and easily accessible.
- Disconnect the Energy Meter from voltage sources before cleaning. The Energy Meter must be cleaned with a dry cloth only.

 **WARNING****Fire hazard**

If a fuse is missing or incorrect, a fire may be caused when a fault occurs. This can result in death or serious injury.

Protect the line conductors of the Energy Meter with a fuse or a main/selective circuit breaker, max. 100 A for single-phase meter and max. 65 A for three-phase meter.

Skills of Qualified Personnel

All installations must be performed by qualified personnel who should have:

- Training for installation and commissioning of electrical system, as well as dealing with hazards;
- knowledge of the manual and other related documents; and
- knowledge of the local regulations and directives.

2 System Solution

WARNING

The inverter must only be operated with PV strings of protection class II in accordance with IEC 61730, application class A. It is not permitted for the positive pole or the negative pole of the PV strings to be grounded. This can cause the inverter to be destroyed.

Damages to the product due to a faulty or damaged PV installation are not covered by warranty.

Any use other than that described in this document is not permitted.

NOTICE

For the TT utility grid, the N line voltage to ground must be 30 V or less.

SH3K6/SH4K6 is a single-phase hybrid inverter applicable to on-grid PV systems. With the integrated Energy Management System (EMS), they can control and optimize the energy flow in order to increase the self-consumption of the system.

Inverter

The type description is as follows:

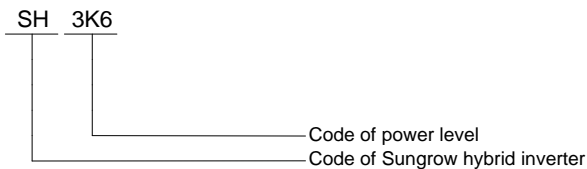

Tab. 2-1 Power Level Description

Type	Nominal Output Power	Nominal Grid Voltage
SH3K6	3680 W	230 Vac (single phase)
SH4K6	4600 W	

The following figure shows the inverter appearance, which is for reference only. The actual product that you receive may differ.

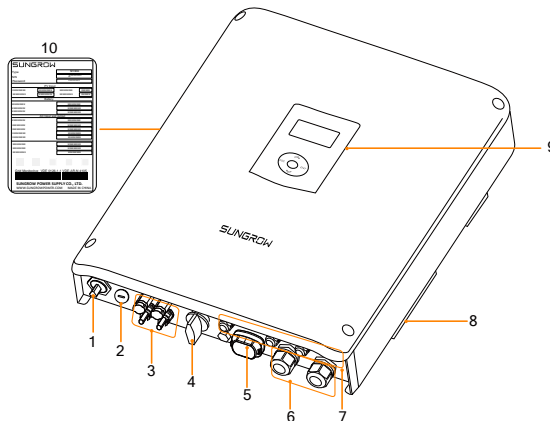

Fig. 2-1 Inverter Appearance

No.	Name	Description
1	AC-Grid	AC terminal to the utility grid.
2	Backup ctrl	Reserved.
3	PV terminals	Positive and negative DC input connectors.
4	DC switch	To safely disconnect the DC circuit.
5	Wi-Fi terminal	To connect the Wi-Fi module (optional).
6	Battery connection	BAT+ and BAT-
7	Communication connection	RS485, Ethernet, CAN, AI, DI and DO.
8	Second PE terminal	For reliable grounding.
9	LCD panel	The display and four buttons can be used to access current operating data or change inverter settings.
10	Nameplate	Clearly identify the product, including the SN, password, technical data, certifications, etc.

The following figure shows the dimensions of the inverter.

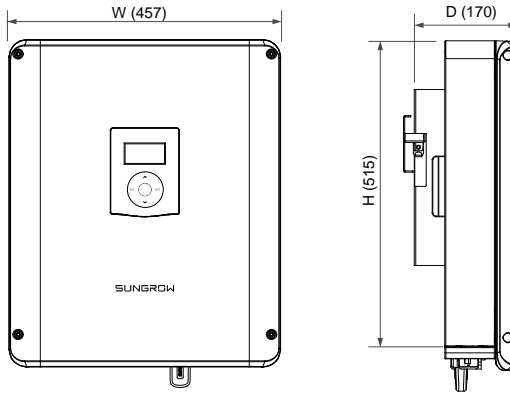

Fig. 2-2 Outline Dimensions (unit: mm)

The LCD panel with an indicator and four buttons is on the front of the inverter.

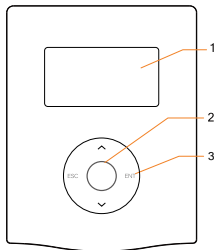

Fig. 2-3 LCD Panel

No.	Name	Description
1	LCD screen	Display and access current operating data or change inverter settings.
2	Indicator	Green and red can be indicated via the indicator, from which user can know the current status. For detailed definition, see Tab. 7-3 .
3	Buttons	View or set parameters via the buttons. For detailed functions, see Tab. 7-1 .

Energy Meter

The Sungrow Energy Meter is installed next to the main switch to detect the electrical measured values at the grid-connected point. It communicates with the inverter via an RS485 connection.

Single-phase Energy Meter and its terminals are shown in the following figure.

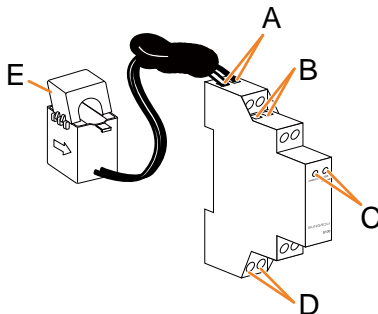

Designation	Description
A 1, 4	For the 1-phase sensor
B 2, 5	2 is for RS485-A 5 is for RS485-B
C	Stead on: the Energy Meter is powered on. Flashing: the Energy Meter is communicating with the inverter. Off: no power supply to the meter.
D 3, 6	3 is for the line conductor 6 is for the neutral conductor
E /	CT clamp for the 1-phase sensor

The dimensions of single-phase Energy Meter are shown as below.

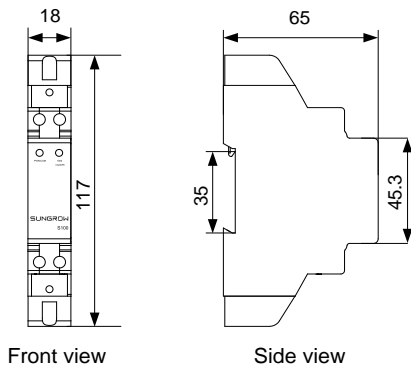
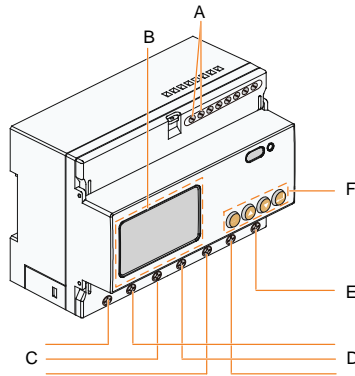

Fig. 2-4 Single-phase Energy Meter Dimensions (unit: mm)

Three-phase Energy Meter and its terminals are shown in the following figure.



Designation		Specification
A	21, 22	RS485 communication terminals
B	LCD screen	Display active energy and reactive energy, etc.
C	L1, L2, L3	Input terminals from grid side
D	L1', L2', L3'	Output terminals to load side
E	N	Neutral terminal
F	Keys	Set key, up key, down key and enter key

The dimensions of three-phase Energy Meter are shown as below.

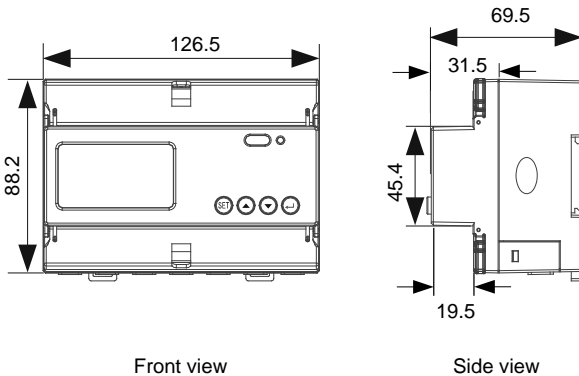

Fig. 2-5 Three-phase Energy Meter Dimensions (unit: mm)



- The single-phase Energy Meter and the three-phase Energy Meter are alternative in the delivery. The Energy Meter figures in this document have been created for the three-phase Energy Meter unless otherwise specified.
- More detailed information on the Energy Meter can be found in the respective Quick Installation Guide.

2.1 PV Energy Storage System (PV ESS)

With a battery module for the immediate storage of energy, the conventional PV system can be upgraded to be a PV ESS.

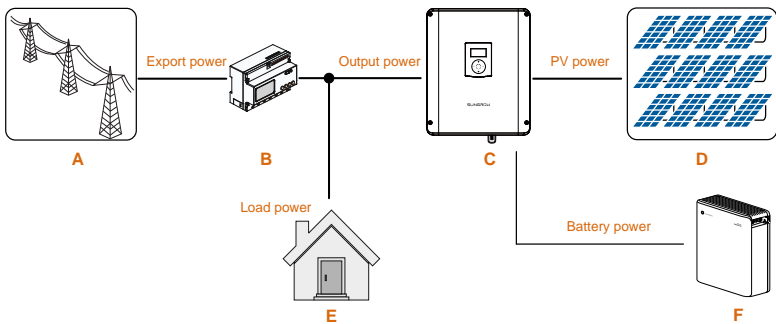

Fig. 2-6 PV Energy Storage System (PV ESS)

Tab. 2-2 System Compositions

Item	Description	Remark
A	Utility grid	Grid grounding system types: TT, TN
B	Sungrow single-phase or three-phase Energy Meter	Measures the export power and communicates with the inverter via the RS485 port.
C	Inverter	SH3K6 / SH4K6.
D	PV strings	Compatible with monocrystalline silicon, polycrystalline silicon, and thin-film without grounding.
E	Household load	Devices that consume energy.
F	Battery (optional)	A Li-ion battery or a lead-acid battery.

Energy Management during Daytime

The energy management system (EMS) works in self-consumption by default. The PV power will go to the house first, then the battery. Then if the battery is fully charged the excess will go to the grid, the export power should not be more than the limit value set in commissioning.

If the PV power is less than the load power, the battery will discharge and provide the energy shortfall. The inverter will draw power from the mains if the power from the PV and battery is less than the load power.

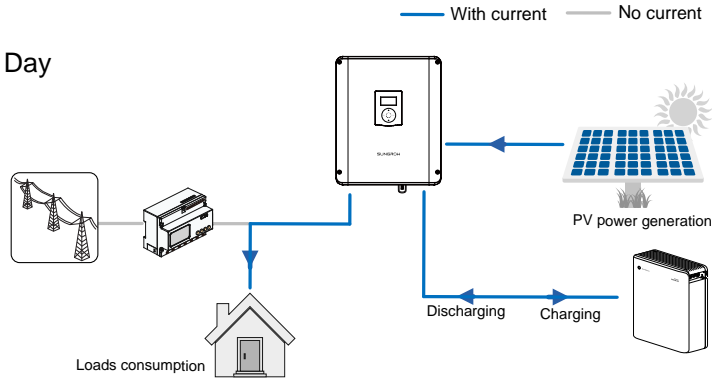

Energy Management during Night

The battery discharges to provide energy to loads. If the battery is empty or there is not enough power from the battery system to supply active loads, the unmet power will be supplied by the grid.

If the Energy Meter is abnormal or not equipped:

- the inverter can run normally;
 - the battery can be charged, but not allowed to discharge;
 - the export power setting on the LCD screen will be ineffective;
- the DO function of optimized mode will be disabled.

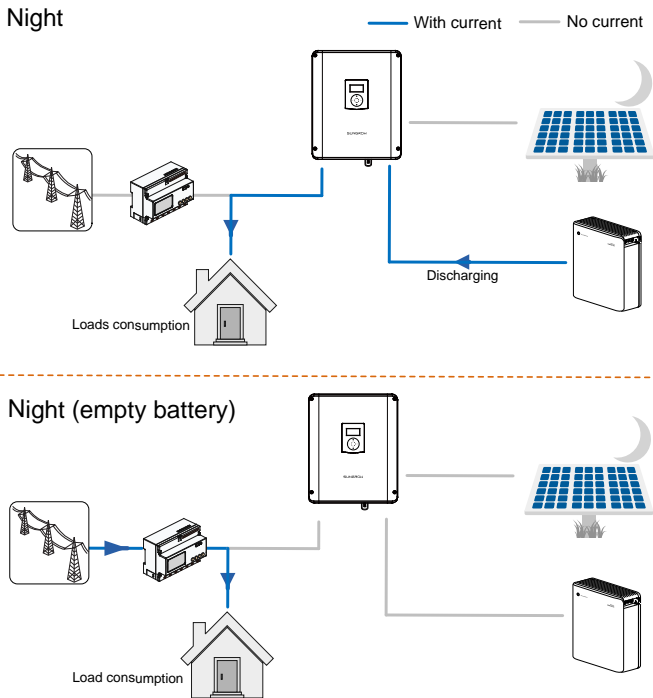

2.2 Retrofitting the Existing PV System

The SH3K6/SH4K6 hybrid inverter is compatible with any single-phase PV grid-connected inverters. An existing PV system can be retrofitted to be a PV ESS with the addition of SH3K6 / SH4K6.

The power generation from the existing PV inverter will be firstly provided to the loads and then charge the battery. With the energy management function of the SH3K6 / SH4K6, the self-consumption of the new system will be greatly improved.

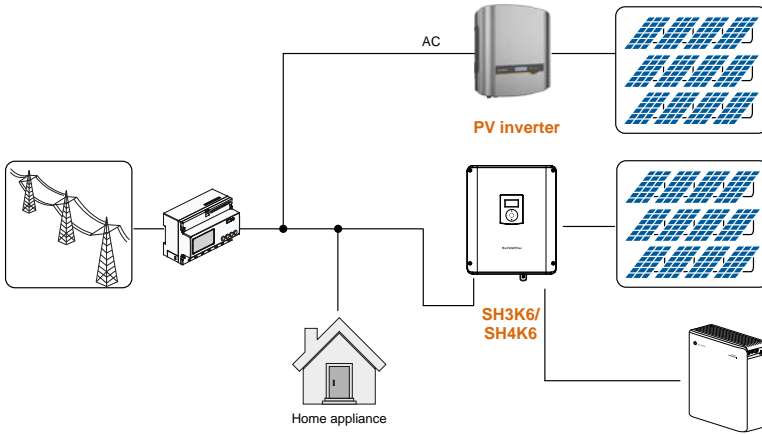
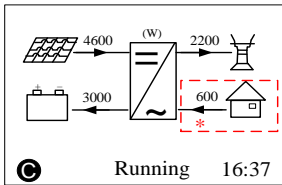

Fig. 2-7 Retrofitting the Existing PV System



* The existing PV inverter works as a load in the whole system but supply PV power to the energy storage system, as the power flow shown on the main screen. Refer to “10.4.2 Adding the Existing System” to set the rated power of the existing PV inverter.

The output power of the existing PV inverter should be taken into consideration for export power setting. For detailed settings, see the zero-export setting in commissioning.

3 Function Description

3.1 Safety Function

3.1.1 Protection

Several protective functions are integrated in the inverter, including short circuit protection, grounding insulation resistance surveillance, residual current protection, anti-islanding protection, DC overvoltage / over-current protection, etc.

3.1.2 Earth Fault Alarm

The inverter has integrated an earth fault dry-contact (DO2 relay) for the local alarm. The external alarm needs to be powered by the grid.

The additional equipment required is a light indicator and/or a buzzer. The recommended cross-section of the DO cable is 1 mm².

If an earth fault occurs:

- the DO2 dry-contact will switch on automatically to signal the earth fault alarm;
- the buzzer inside the inverter will also beep;
- the Ethernet communication port can be used for transmitting the alarm remotely.

3.1.3 SPI and Auto Test (Italy only)

The auto test system will check the maximum/minimum frequency and voltage provided in the interface protection system (SPI). For each frequency and voltage protection function, the tripping threshold varies linearly upward or downward with a slope of ≤ 0.05 Hz/s or ≤ 0.05 V/s respectively for the frequency and voltage protection. For details, see “**10.8 Auto Test (Italy)**”.

The integrated SPI is capable to receive the signals aimed at changing the frequency protection thresholds or the command of remote shutdown. For details, see “**11.2.6 Interface Protection System (SPI)**”.

3.2 Energy Conversion and Management

The inverter converts the DC power from the PV array or the battery to the AC power, in conformity with the grid requirements. It also transmits the DC power from the PV panel to the battery.

With the bidirectional converter integrated inside, the inverter can charge or discharge the battery.

Two string MPP trackers can be used to maximize the power from PV strings with different orientations, tilts, or module structures.

3.2.1 Power Derating

Power derating is a way to protect the inverter from overload or potential faults. In addition, the derating function can also be activated following the requirements of the utility grid. Situations requiring inverter power derating are:

- grid dispatching
- over-temperature (including ambient temperature and module temperature)
- grid under-voltage
- export power limit setting
- power factor (when values out of the rated values)

Grid Dispatching Derating

Adjust the output power according to the remote scheduling instructions and the inverter operates with the power derating.

Over-temperature Derating

A high ambient temperature or poor ventilation will lead to a power derating of the inverter.

When the internal temperature or module temperature exceeds the upper limit, the inverter will reduce the power output until the temperature drops within the permissible range.

Grid Under-voltage Derating

When the grid voltage is too low, the inverter will reduce the output power to make sure that the output current is within the permissible range, as calculated by the following equation.

When $V_{min} < V < 230 \text{ V}$, $P = P_n \times (V_{grid} / 230 \text{ V})$

The following figure shows the under-voltage derating curve.

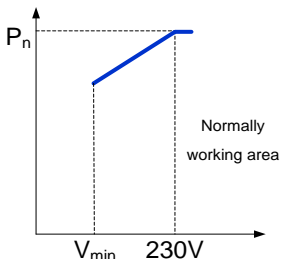

Fig. 3-1 Grid Under-voltage Derating

Export Power Limit Derating

When the Energy Meter detects that the export power is greater than the limit value on the LCD, the inverter will reduce the output power within the specified range.

Power Factor Derating

When the power factor $PF < 1.0$, the inverter will reduce the output power within a specified range. The following figure shows the power factor derating curve.

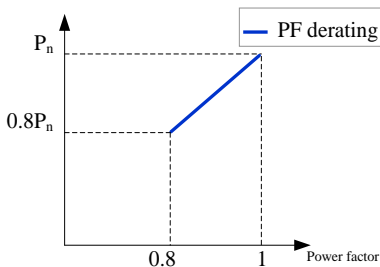

Fig. 3-2 Power Factor Derating

3.2.2 Regular Operational Voltage Range

The inverters can operate within the allowable voltage range for at least the specified observation time. The setting of the conditions depends on whether the connection is due to a normal operational start-up or an automatic reconnection after tripping of the interface protection.

When the voltage level is out of the operational levels, the inverter will disconnect from the grid within the protection time. If a disturbance lasts less than the required protection time, the inverter can reconnect to the grid once the

voltage level goes back to normal levels after the disturbance.

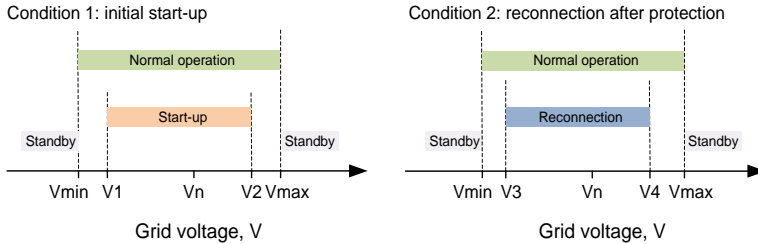

Fig. 3-3 Inverter Action related to Grid Voltage (“DE” for example)

Tab. 3-1 Operational Voltage Parameter Description

Parameter	Explanation
Grid-connection	
V1	Lower voltage limit for initial start-up
V2	Upper voltage limit for initial start-up
V3	Lower voltage limit for reconnection
V4	Upper voltage limit for reconnection
t_v	Minimum observation time
k_v	Connection or recovery gradient
Protection	
V_{min}	Under-voltage protection value
V_{max}	Over-voltage protection value
T_{min}	Under-voltage protection time
T_{max}	Over-voltage protection time

Tab. 3-2 Default Values of Operational Voltage Parameter

Parameter	DE	BE	LUX	NL	IT
V1 (V)	195.5	195.5	195.5	195.5	195.5
V2 (V)	253.0	253.0	253.0	253.0	253.0
V3 (V)	195.5	195.5	195.5	195.5	195.5
V4 (V)	253.0	253.0	253.0	253.0	253.0
t_v (s)	60	60	60	60	30 or 300 ⁽³⁾
k_v	25 % Pn/min or 10 % Pn/min ⁽¹⁾	Not applicable or Pn/min ⁽²⁾		10 %	20 % Pn/min
V_{min} (V)	184.0 for stage I 103.5 for stage II,	184.0	184.0	184.0	184.0 for stage I 34.5 for stage II
V_{max} (V)	287.5	264.5	264.5	253.0	264.5
T_{min} (s)	3.0 for stage I, 0.3 for stage II	0.2	1.35	2.0	1.5 for stage I, 0.2 for stage II
T_{max} (s)	0.1	0.2	0.15	2.0	0.2

- (1) 25 % Pn/min for initial connection and 10 % Pn/min for reconnection.
- (2) Not applicable for initial connection and 10 % Pn/min for reconnection.
- (3) 30 s for initial connection and 300 s for reconnection.

3.2.3 Regular Operational Frequency Range

The inverter can operate within its frequency range for at least the specified observation time. The setting of conditions depends on whether the connection is due to a normal operational start-up or an automatic reconnection after tripping of the interface protection.

When the frequency level is outside the operational levels, the inverter will disconnect from the grid. If a disturbance lasts less than the required protection time, the inverter can reconnect to the grid once the frequency level goes back to normal levels after the disturbance.

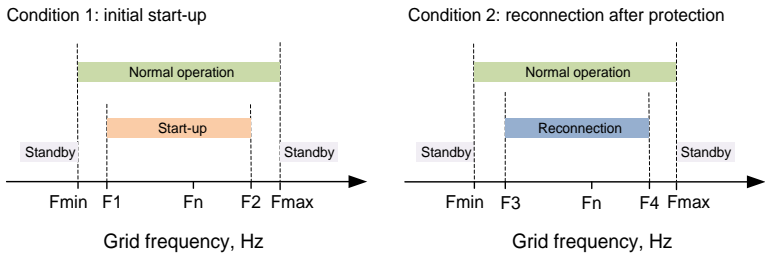

Fig. 3-4 Inverter Action related to Grid Frequency (“DE” for example)

Tab. 3-3 Operational Frequency Parameter Description

Parameter	Description
Grid-connection	
F1	Lower frequency limit for initial start-up
F2	Upper frequency limit for initial start-up
F3	Lower frequency limit for reconnection
F4	Upper frequency limit for reconnection
t_f	Minimum observation time
k_f	Connection gradient
Protection	
F_{min}	Under-frequency protection value
F_{max}	Over-frequency protection value
T_{min}	Under-frequency protection time
T_{max}	Over-frequency protection time

Tab. 3-4 Default Values of Operational Frequency Parameter

Parameter	DE	BE	LUX	NL	IT (1)	IT (0)
F1 (Hz)	47.50	47.50	47.50	48.00	49.90	49.90

Parameter	DE	BE	LUX	NL	IT (1)	IT (0)
F2 (Hz)	50.10	50.10	50.10	50.10	50.10	50.10
F3 (Hz)	47.50	47.50	47.50	48.00	49.50	47.50
F4 (Hz)	50.10	50.05	50.05	50.05	50.50	51.50
t _r (s)	60	60	60	60	30 or 300 ⁽³⁾	
k _r	25 % Pn/min or 10 % Pn/min ⁽¹⁾	Not applicable or Pn/min ⁽²⁾		10 %	20 % Pn/min	
F _{min} (Hz)	47.50	47.50	47.50	48.00		
F _{max} (Hz)	51.50	51.50	52.00	51.00	See Tab. 11-7 ⁽⁴⁾	
T _{min} (s)	0.1	0.2	0.4	2.0		
T _{max} (s)	0.1	0.2	0.4	2.0		

(1) 25 % Pn/min for initial connection and 10 % Pn/min for reconnection.

(2) Not applicable for initial connection and 10 % Pn/min for reconnection.

(3) 30 s for initial connection and 300 s for reconnection.

(4) For Italy, the over- / under- frequency protection value and time can be controlled by the SPI function or a remote command via RS485 communication. Please refer to “**11.2.6 Interface Protection System (SPI)**” for details.

3.2.4 Active Power Regulation

Over- / Under- Voltage Response

Only applicable to Italy. The power response to the grid voltage variations can be set via the LCD, the details are described in “**11.2.4 Volt-watt Response**”.

Over-Frequency Response

The over-frequency response for the country Italy is described in “**11.2.5 Frq-watt Response**”.

The over-frequency response for the other countries is described in “**11.1.4 Over-frequency Response**”.

Under-Frequency Response

For the country Germany, when there is a decrease in grid frequency which exceeds the Start value, the inverter will increase the power output linearly with a decrease of frequency until the End value is reached.

Tab. 3-5 Definition of Under-frequency Response Parameters

Parameter	Description	Default Value
UnderFrq Start	Start frequency value for under-frequency response	49.80 Hz
UnderFrq End	Stop frequency value for under-frequency response	47.50 Hz

Parameter	Description	Default Value
P _m	Actual AC output power at the instance when the frequency reaches the Start frequency	-
Gradient	Active power increase rate relative to the actual power P _m per Hz	100% P _m /Hz

The following figure shows the under-frequency response.

Between the Start value and the End value, all adjustable power generation systems shall reduce (for frequency increase) or increase (for frequency decrease) the active power P_m generated instantaneously.

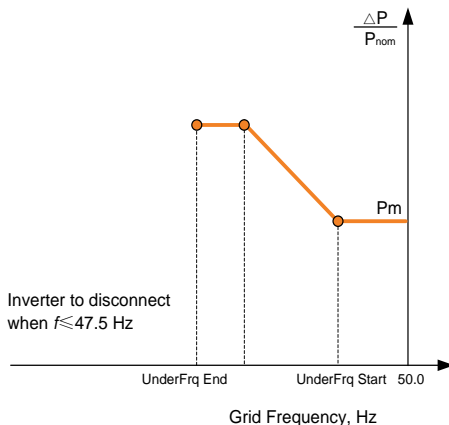

Fig. 3-5 Active Power Response at Under-frequency

If the grid frequency increases and is between 49.80 Hz and 50.20 Hz, the active power supplied to the grid will recover with a gradient not exceeding 10 % of the maximum active power per minute.

For the country Italy, the under-frequency response is described in “11.2.5 Frq-watt Response”.

3.2.5 Reactive Power Regulation

The inverter is capable of operating in reactive power regulation modes for the purpose of providing support to the grid.

For the country Italy, the Q(U) mode can only be set via the iSolarCloud App or the iSolarCloud server. The other modes can be set via the LCD menu.

For the countries except Italy, the Q(U) and Q(P) modes can only be set via the iSolarCloud App or the iSolarCloud server. The other modes can be set via the LCD menu. For details, see “11 Appendix IV: Power Response”.

- **PF:** Fixed power factor mode. The PF mode controls the active power factor of the inverter's output according to a set-point set via the LCD. The PF ranges from 0.8 leading (+) to 0.8 lagging (-), with the default value of +1.0.
- **Qt:** Fixed reactive power mode.
- **Q(P):** Power related control mode. The displacement power factor of the inverter output varies in response to the output power of the inverter.
- **Q(U):** Voltage related control mode. The reactive power output of the inverter varies in response to the grid voltage.

3.2.6 Load Control

The inverter provides a load control dry-contact (DO1 relay), which can control the load via a contactor. Refer to “**6.7 DO Connection**” for the cable connection.

User may set the control mode according to individual demand. Refer to “**10.4.9 Setting Load Control**” for LCD settings.

Timer: Set the starting time and end time. The DO function will be enabled during the time interval.

ON/OFF: The DO function can be enabled if **ON** or disabled if **OFF**.

Optimized: Set the starting time, end time, and the optimized power. During the interval, when the export power reaches to the optimized power, the DO function will be enabled.

3.3 Battery Management

The batteries compatible with the PV ESS must meet the IEC 62109 certification. The battery kinds are as follows. Further battery models will be made compatible in the future.

- Li-ion battery from SUNGROW, LG Chem, GCL, Pylon, BYD and TAWAKI.
- Lead-acid battery which require manual configuration.

To maximize the battery life, the inverter will perform battery charge, discharge, and battery maintenance based on the battery status communicated by the BMS.

NOTICE

The recommended parameters listed in this section may be updated or revised due to product development. Please refer to the manual supplied by the battery manufacturer for the latest information.

State Definition

In order to avoid overcharging or deep discharging of the battery, distinguish four battery statuses according to different voltage ranges, as shown in the following table.

Tab. 3-6 Battery Status Definition

Type	Port Voltage / SOC			
	Damaged	Empty	Normal	Full
SUNGROW (new system)	< 28 V	SOC < 5 %	5 %...100 %	SOC = 100 %
SUNGROW (retrofitting system or with the forced charge function enabled)	< 28 V	SOC < 10 %	10 %...100 %	SOC = 100 %
LG (RESU G1/G2)	< 30 V	SOC < 5 %	5 %...100 % (by default)	SOC > 95 %
GCL	< 30 V	SOC < 15 %	15 %...95 % (by default)	SOC > 95 %
Pylon (US2000B), TAWAKI	< 30 V	SOC < 20 %	20 %...100 % (by default)	SOC = 100 %
BYD	< 30 V	SOC < 10 %	10 %...100 % (by default)	SOC = 100 %
Other lead-acid	< 30 V	Configured by the customer		

* The SOC limits of Li-ion batteries except Sungrow batteries can be modified via the iSolarCloud App or the iSolarCloud server by qualified personnel.

3.3.1 Charge Management

Emergency Charge Management

To avoid the damage caused by long time excessive discharge,

- For lead-acid battery, if the battery voltage is under the lower limit, the system will enter emergency charge management.
- For Li-ion battery, if the battery SOC is under the lower limit, the system will enter emergency charge management.

The inverter cannot respond to the discharge command during emergency charge. The following table describes the emergency charge of different types of batteries.

Tab. 3-7 Emergency Charge Description

Type	Trigger Condition	Finishing Condition
SUNGROW (new system)	Not applicable	Not applicable

Type	Trigger Condition	Finishing Condition
SUNGROW (retrofitting system)	SOC \leq 2 %	SOC \geq 4 %
LG (RESU G1/G2)	SOC \leq 2 %	SOC \geq 4 %
GCL	SOC \leq 12 %	SOC \geq 14 %
Pylon (US2000B)	SOC \leq 17 %	SOC \geq 19 %
TAWAKI	SOC \leq 15 %	SOC \geq 17 %
BYD	SOC \leq 7 %	SOC \geq 9 %
Lead-acid	The battery voltage is lower than the lower limit of under-voltage. (42 V by default)	The battery voltage rises to the setting value of under-voltage protection value.

Normal Charge Management

When the battery voltage is within the normal range, the inverter could charge the battery if the PV power is higher than the load power and could ensure that the battery is never over-charged.

The maximum allowable charge current of battery is mainly limited to the maximum charge current of the inverter 65A and the maximum / recommended charge current from the battery manufacturer.



- If the PV voltage is higher than the upper limit value of MPP voltage 560 V, the battery cannot charge.
- The hybrid system will start to charge the battery when the export power value exceeds a threshold value of 70 W.

3.3.2 Discharge Management

Discharge management can effectively protect the battery from deep discharging.

The maximum allowable discharge current of battery is mainly limited to the maximum discharge current of the inverter 65A and the maximum / recommended discharge current from the battery manufacturer.



- If the PV voltage is higher than the upper limit value of MPP voltage 560 V, the battery cannot discharge.
- The hybrid system will start to discharge the battery when the import power value exceeds a threshold value of 70 W.

3.3.3 Maintenance Management

To maximize the lead-acid battery life, the inverter will maintain the lead-acid battery every six months, no matter whether the PV power is sufficient or not. Generally, the maintenance management is only suitable for a lead-acid battery.

The maintenance process is as follows.

1. Charge the battery with a constant current according to a C-rate of 0.165 C. C is the nominal capacity specified by the manufacturer and is indicated in Ah.
2. Charge the battery with a trickle current when the battery voltage is stabilized at the average charge voltage.
3. When the trickle current decreases to 3 A, end the maintenance.

3.3.4 Battery Temperature Sensor (PT1000)

The inverter has integrated a PT1000 temperature sampling port for lead-acid batteries. With the external PT1000 installed, inverter can sample the temperatures of the external environment or the battery cabinet. The system uses the sensor input to perform power derating, battery over-temperature and under-temperature protection.

The sampling temperature of PT1000 ranges from -25°C to +60°C, with the accuracy of $\pm 2^\circ\text{C}$. The protective temperature of lead-acid battery ranges from -25°C to +60°C and the values could be set on the LCD or the iSolarCloud App or the iSolarCloud server.

The temperature sampling function of the sensor PT1000 for lead-acid batteries is disabled by default. Refer to “**10.4.12 PT1000 Switch Setting**” to enable the function via LCD menu.

3.4 Communication and Configuration

- Communication interfaces

The inverter provides various ports for device and system monitoring, including RS485, Ethernet, Wi-Fi, and CAN.

- Parameter configuration

The inverter provides various parameter configurations for optimal operation.

- Data storage and display

The inverter records running information and error information. They are displayed on the LCD screen.

4 Unpacking and Storing

4.1 Unpacking and Inspecting

The inverter is thoroughly tested and strictly inspected before delivery. Damage may still occur during shipping. Therefore, the first thing you should do after receiving the device is to conduct a thorough inspection.

1. Check the packaging for any visible damage.
2. Check the delivery contents for completeness according to the packaging list.
3. Check the inner contents for any visible damage.

Contact SUNGROW or the distributor in case of any damaged or missing components.

It is the best choice to store the inverter in the original packaging. So, do not dispose of it.

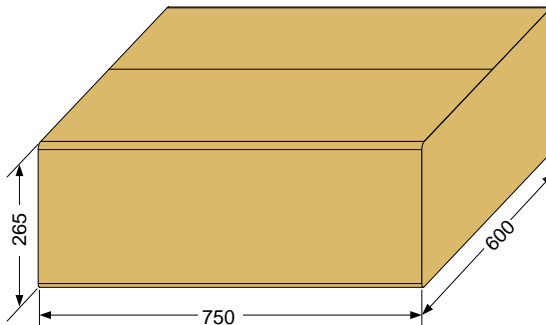

Fig. 4-1 Single Inverter in Original Packaging Carton (unit: mm)

4.2 Delivery Contents

Standard Delivery

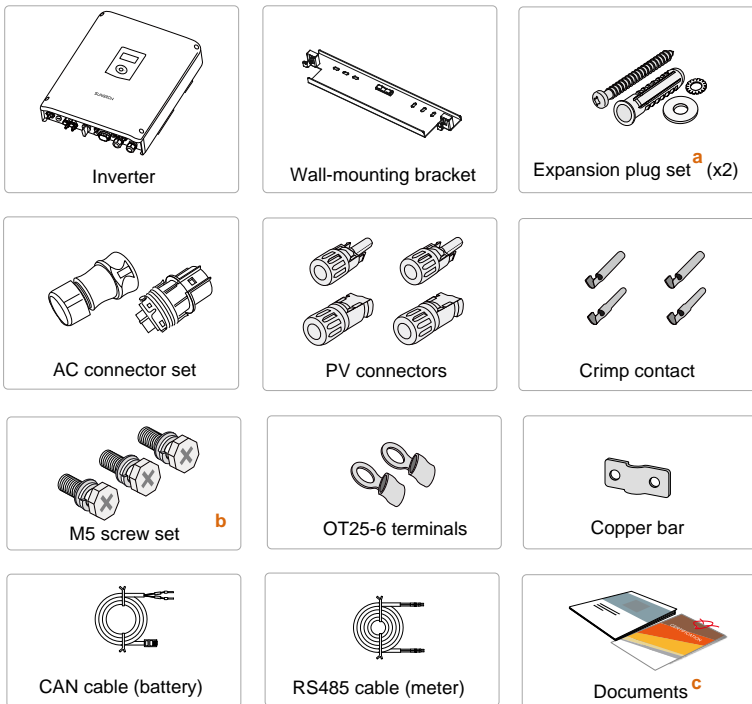
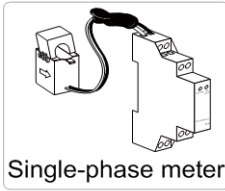

Fig. 4-2 Delivery Contents

- Each set includes a self-tapping screw, a spring washer, a fender washer, and an expansion tube.
- One is for external grounding and the other two are for securing the inverter.
- The documents include a Quick Installation Guide for the inverter, a Quick Installation Guide for the Energy Meter, a packaging list, warning labels, quality certificates and product test reports.

Optional Accessory

The optional accessory is not included in the inverter packaging but, if ordered, delivered separately.



Single-phase meter

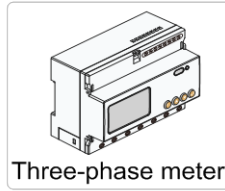

Three-phase meter



Wi-Fi module

4.3 Storing the Inverter

If you do not install the inverter immediately, choose an appropriate location to store it. Instructions for storage are:

- The inverter must be stored in the original packaging.
- The storage temperature should be always between -30°C and $+70^{\circ}\text{C}$, and the storage relative humidity should be always between 0 and 100 %, non-condensing.

The following figure shows the storage of the inverter.

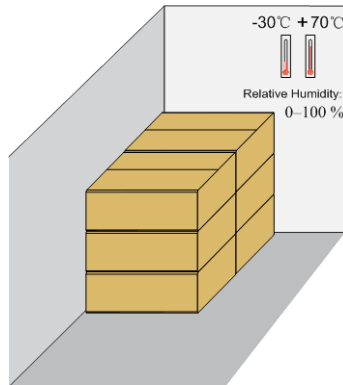

Fig. 4-3 Example of Inverter Storage

NOTICE

The packaging should be upright.

When storing inverters, do not stack more than 5 inverter packages on top of each other.

5 Mechanical Mounting

5.1 Safety during Mounting

DANGER

In order to avoid electric shock or other injury, be sure there is no electricity or plumbing installations before drilling holes.

CAUTION

Risk of injury due to improper handling

- The weight can cause injuries, serious wounds, or bruise.
- Always follow the instructions when moving and positioning the inverter.

System performance loss due to bad ventilation

- The inverter requires good ventilation during operation. Keep it upright and nothing covering the heat sink.

NOTICE

Wear gloves to avoid scratches when mounting the inverter.

5.2 Location Requirements

The inverter with IP65 can be installed indoors or outdoors.

Selecting an optimal location for the inverter is critical for its operating safety as well as the expected efficiency and service life. Considerations for the location include:

1. The structure should be capable of withstanding a force of four times the weight of the inverter.
2. Install the inverter where it is convenient for installation, cable connection and service.
3. The location should be not accessible to children.

4. The max. power output will reduce when the ambient temperature exceeds 45°C. The following figure shows the ambient temperature and relative humidity limits.



5. Only mount the inverter on a non-flammable surface or a wooden structure. Keep away from flammable materials or gas. Do not enclose the inverter into a tight confinement.

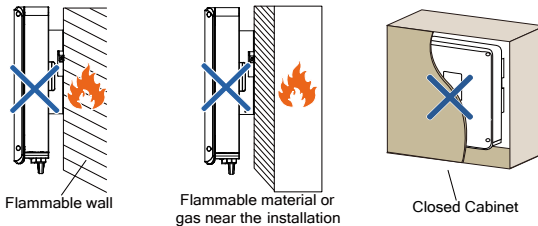

6. Prevent the inverter from direct exposure to sun, rain and snow.
7. Install at eye level for easy inspection.
8. Install vertically for good heat dissipation.

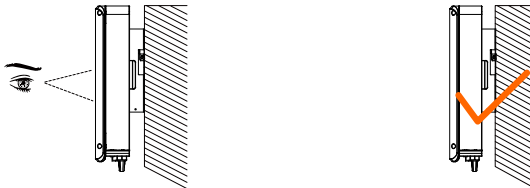



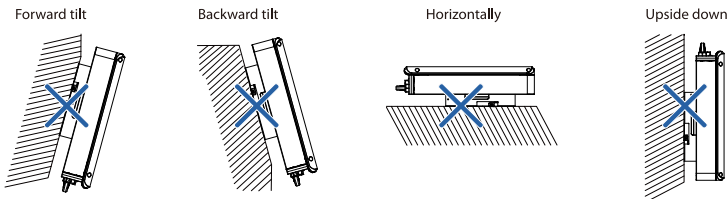



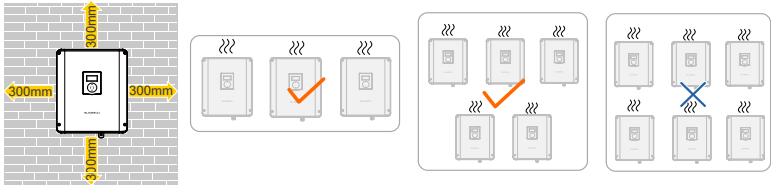



9. Never install the inverter horizontally, or with a forward tilt or with a backward tilt or even with upside down. The horizontal installation can result in damage to the inverter.

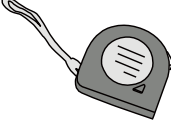
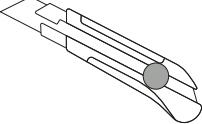
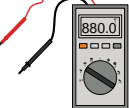



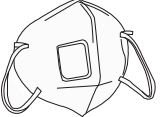



10. Clearance requirement and multiple installation:

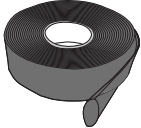

5.3 Tools

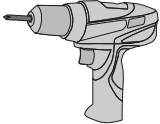
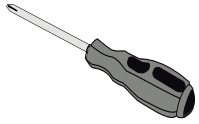
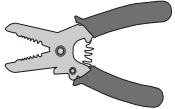
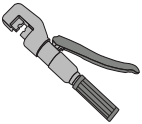
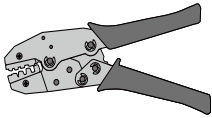
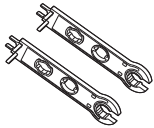
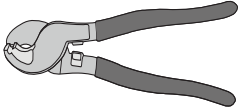
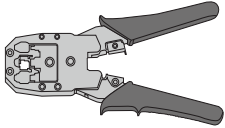
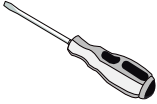
General tools (recommended)		
Packaging tape 	Marker 	Measuring tape 
Utility knife 	Multimeter Measurement range: $\geq 1100\text{Vdc}$ 	Protective clothing 
Wrist strap 	Protective gloves 	Dust mask 
Earplugs 	Goggles 	Insulated shoes 

<p>Vacuum cleaner</p> 	<p>Heat shrink tubing</p> 	<p>-</p>
<p>Installation tools (recommended)</p>		
<p>Heat gun</p> 	<p>Hammer drill Drill bit: $\Phi 10$</p> 	<p>Rubber mallet</p> 
<p>Electric screwdriver Tool bit: M5</p> 	<p>Phillips screwdriver Specification: M5</p> 	<p>Wire stripper</p> 
<p>Hydraulic plier</p> 	<p>Crimping tool Crimping range: 2.5-6mm²</p> 	<p>Wrench for MC4 terminal</p> 
<p>Wire clipper</p> 	<p>RJ45 crimping tool</p> 	<p>Flat-blade screwdriver M2</p> 

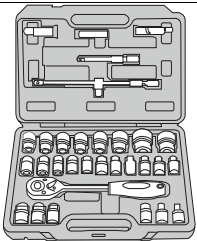
<p>Torx screwdriver TX30</p> 	<p>Socket wrench Open end: 10mm (for M6 bolts) 13mm (for M8 bolts) 16mm (for M10 bolts)</p> 
--	---

5.4 Installing the Inverter

Install the inverter on the wall by means of the wall-mounting bracket and expansion plug sets.

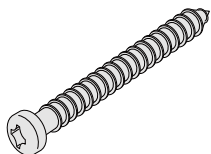

Self-tapping screw M6

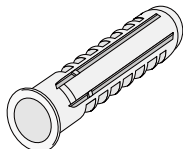

Expansion tube



Fender washer



Spring washer

1. Install the wall-mounting bracket with a torque of 9.0 N·m.

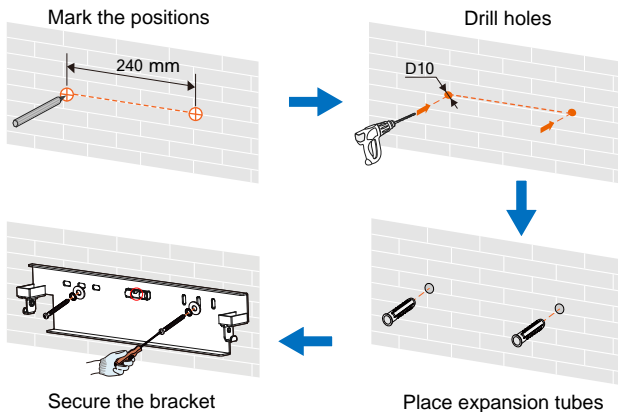

Note:

- (1) The depth of the holes should be about 70 mm.

(2) Be sure to adhere to the following screw assembly sequence: self-tapping screw, spring washer, fender washer and bracket.

(3) The air bubble in the bracket must be between the two lines in the red circles to ensure the horizontal level.

2. Mount the inverter to the bracket.

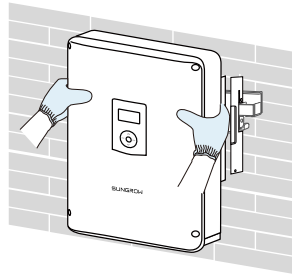

3. Secure the inverter with two M5 screws and washers. (3.0 N·m)

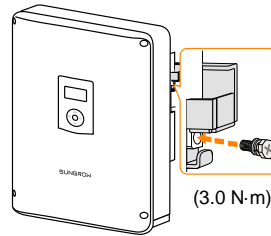

5.5 Grounding the Inverter

A second protective earth (PE) terminal is equipped at the side of the inverter. Be sure to connect this PE terminal to the PE bar for reliable grounding and ensure that the grounding resistance should be less than 10 Ohm.

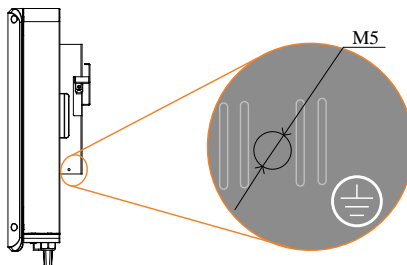
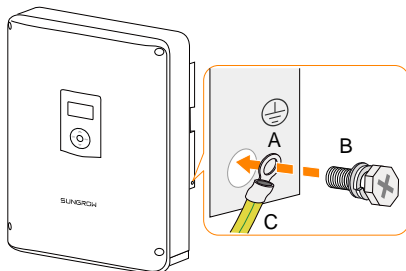

Fig. 5-1 Second PE Terminal

WARNING

Correct connection of both PE terminals is mandatory. Not properly connecting both PE will void any or all product warranty.

Second PE Connection



Item	Description	Specification
A	Cable socket	Not included in the delivery scope.
B	Screw	M5×12 mm (3.0 N·m)
C	Yellow-green cable	The second PE conductor must be of the same cross-sectional area as the original PE conductor in the AC connector. The cable is not included in the delivery scope.

5.6 Installing the Energy Meter

The Sungrow Energy Meter should be installed between the grid and the load. It supports a 35 mm DIN-rail installation, as shown in the following figure.

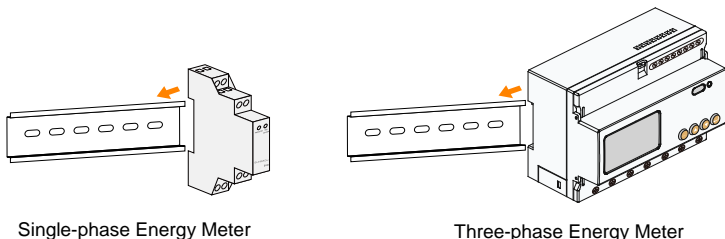

Fig. 5-2 Installing the Energy Meter to the Rail

6 Electrical Connection

This chapter mainly describes the cable connections of the system.

DANGER

Danger to life due to a high voltage inside the inverter

- Make sure that the cables are not live before electrical connection.
- Do not turn on the AC circuit breaker until all the electrical connections are completed.

WARNING

All cables must be firmly attached, undamaged, properly insulated and adequately dimensioned.

NOTICE

All electrical connections must be in accordance with local and national standards.

Before fastening the lid, be sure that:

- seal the unused terminals with waterproof plugs.
- the rubber strip is fully filled with air.

6.1 Terminal Description

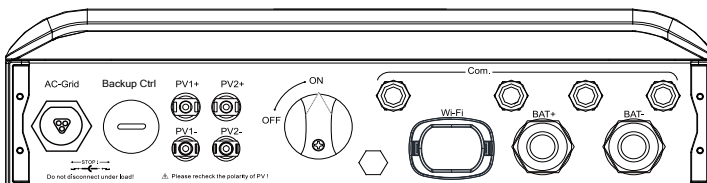
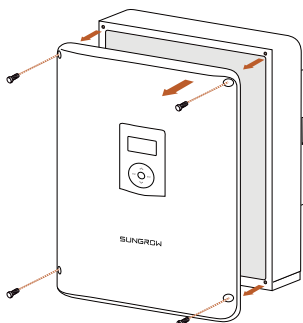

Fig. 6-1 Terminals at the Bottom of the Inverter

Label	Description	Decisive Voltage Classification
AC-Grid	AC terminal to the utility grid.	DVC-C
Backup Ctrl	Reserved.	Not applicable
PV1+, PV1-, PV2+, PV2-	Terminals for the DC cables.	DVC-C
ON, OFF	DC switch.	Not applicable
Com.	Cable glands for Ethernet, RS485, CAN, AI, DI and DO.	DVC-A
Wi-Fi	Terminal for the Wi-Fi module.	DVC-A
BAT+ , BAT-	Cable glands for the battery power cables.	DVC-C

Unscrew four screws and remove the enclosure lid. Retain the screws for later installation (torque 4.2 N·m).



Connection terminals on the inner configuration circuit board are shown below:

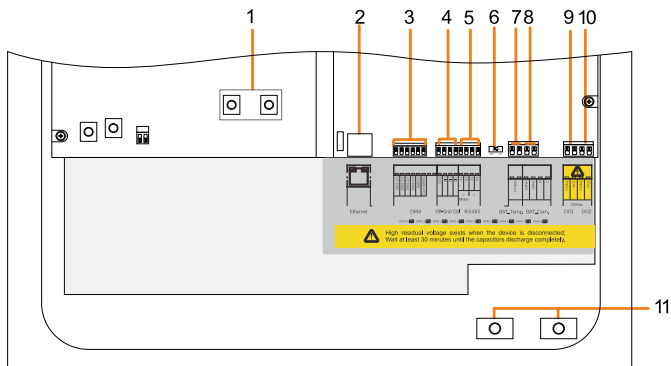

Fig. 6-2 Configuration Circuit Board Inside the Inverter

No.	Label	Connection	Tool Requirements	Decisive Voltage Classification
1	Copper	PV (Parallel mode)	Phillips screwdriver	DVC-C
2	Ethernet	Communication	-	DVC-A
3	DRM	Local control for SPI (Italy)	Flat-head screwdriver with an open end of 2 mm	DVC-A
4	DI	Reserved	-	DVC-A
5	RS485	A1, B1 for external device, A2, B2 for the meter	Flat-head screwdriver with an open end of 2 mm	DVC-A
6	120 Ohm	RS485	-	Not applicable
7	BAT_Temp.	Temperature sensor PT1000		
8	BAT_Com. (CANH, CANL)	Battery communication	Flat-head screwdriver with an open end of 3 mm	DVC-A
9	DO1	Power management		
10	DO2	Earth fault alarm		
11	BAT+, BAT-	Battery	Phillips screwdriver	DVC-C

6.2 Energy Meter Connection

If the RS485 cable is prepared by the customer, we recommend a shielded twisted pair cable or shielded Ethernet cable.

The Energy Meter must only be connected to the distribution board of household loads next to the main switch, as shown in the following figure.

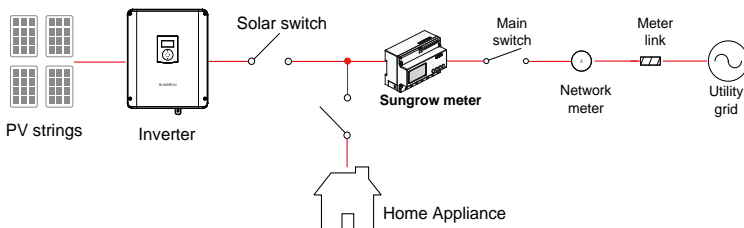

For Three-phase Energy Meter

1. Take out the meter and RS485 cable from the packaging.

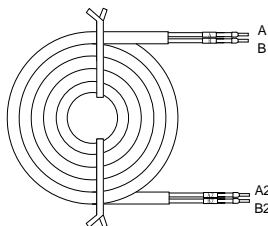

2. Connect the plugs A and B to terminals 21 and 22 on the Energy Meter.

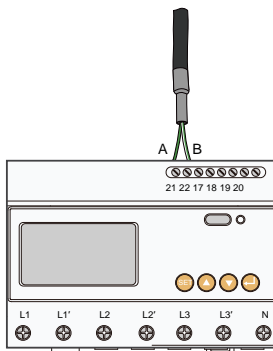

3. Strip the insulation from the power wires by 10 mm. Then connect the wires to the terminals on the Smart Energy Meter, as shown below. (Cross-section: 10 mm² to 25 mm²)

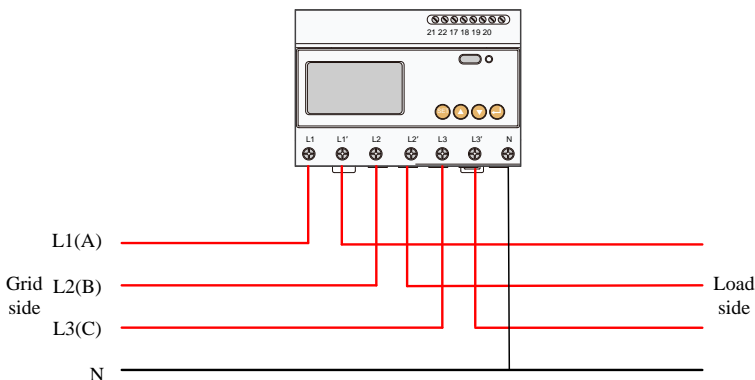



- The line conductor L1 supplies power to the Energy Meter. At least the line conductor L1 and the neutral conductor must be connected to the Energy Meter.
- Just connect the line conductors L1, L1' and the neutral conductor, then the three-phase Energy Meter can be used as a single-phase Energy Meter.

For Single-phase Energy Meter

1. Take out the Energy Meter (with 1-phase sensor) and the cables from the packaging.

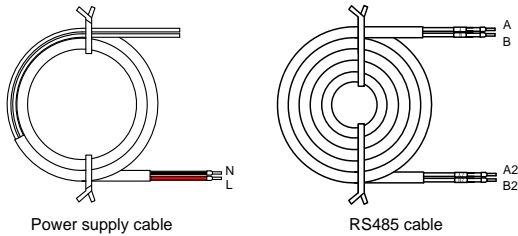

2. Connect the cables to the Energy Meter.

NOTICE
Make sure that the 1-phase sensor is installed in the right direction: the arrow on the sensor must point away from the grid towards the load.

- (a) Tighten the power supply wires to terminal **3 (L)** and terminal **6 (N)**.
- (b) Tighten the RS485 wires to terminal **2** and terminal **5**.
- (c) Place the CT clamp of 1-phase sensor before or after the main switch.

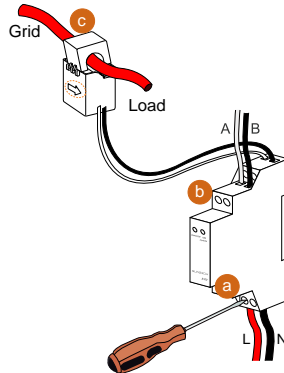

On the Inverter Side

Proceed as follows to connect the RS485 wires to the inverter.

1. Unscrew the swivel nut from any **Com.** Port.

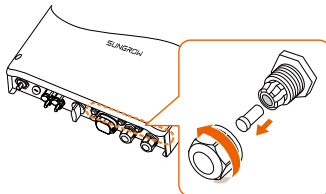

2. Lead the cable through the cable gland. Plug the wires to terminals **A2** and **B2** on the inverter without tool tightening.

Note:

For reconnection, press the part as shown in the red circle so as to pull out the cable.

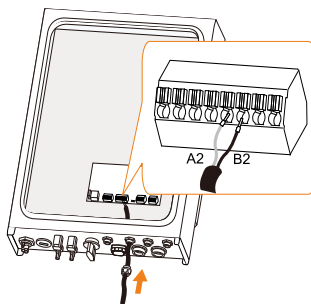

3. When the length of RS485 cable is longer than 100 m, push the 120 Ohm (**2**) switch to "ON" to ensure stable communication, as shown below.

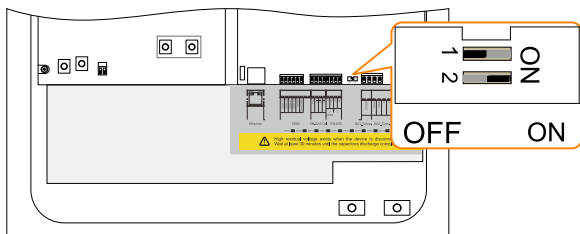

6.3 Grid Connection

Residual Current Device

With an integrated universal current-sensitive residual current monitoring unit inside, the inverter will disconnect immediately from the mains power as soon as a fault current with a value exceeding the limit has been detected.

However if an external residual current device (RCD) is mandatory, the switch must be triggered at a residual current of 300 mA (recommended), or it can be set to other values according to local regulations.

Cable Requirements

Cross-section: 4 mm², cable diameter: 11 mm to 14 mm

All the AC cables should be equipped with correctly colored cables for distinguishing. Please refer to related standards about the wiring color.

6.3.2 Assembling the AC Connector

Take out the AC connector parts from the packaging.

1. Lead the AC cable through the cable gland and the housing.

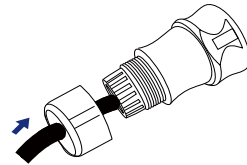

2. Remove the cable jacket by 40 mm, and strip the wire insulation by 8 mm–15 mm.

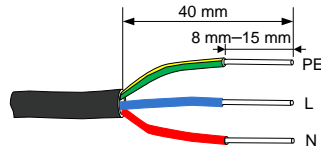

3. Fully insert the conductors to the corresponding terminal and tighten the screws with the torque 0.8 N·m. Pull cables outward to check whether they are firmly installed.

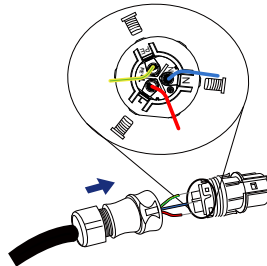

NOTICE

Observe the terminal layout of terminal block.

Do not connect the phase lines to “PE” terminal, otherwise the inverter will not function properly.

- Assemble the housing, the terminal block and cable gland (torque 4 N·m–5 N·m). Make sure that the rib of the terminal block and the groove on the housing engage perfectly until a “Click” is heard or felt.

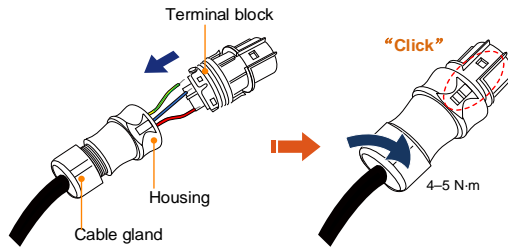

6.3.3 Installing the AC Connector

Procedure:

- Install an AC circuit breaker next to the AC output of the inverter.

Inverter Type	Specification for AC Circuit Breaker
SH3K6	20 A
SH4K6	32 A

- Disconnect the AC circuit breaker and secure it against reconnection.
- Align the AC connector and the AC terminal and mate them together by hand until a “Click” is heard or felt.

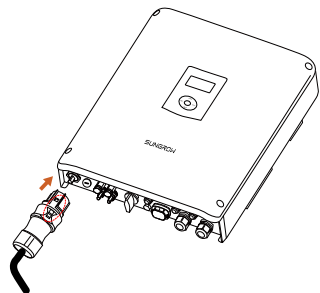

- Connect the other ends. Connect “PE” conductor to the grounding electrode. Connect “L” and “N” conductors to the AC circuit breaker.
- Pull all the lines outward to check whether they are firmly installed.

6.4 PV Connection

WARNING

Before connecting the PV array to the inverter, ensure that the impedances between the positive terminals of the PV string and Earth, and between the negative terminals of the PV string and Earth are larger than 200 kOhm.

6.4.1 PV Input Configuration

Independent Mode

The two PV inputs work independently, each with its own MPPT. The two PV inputs can be different from each other in PV module types, numbers of PV panels in PV strings, tilt angles and orientation angles of PV modules. The following figure details the need for a homogenous PV string structure for maximum power.

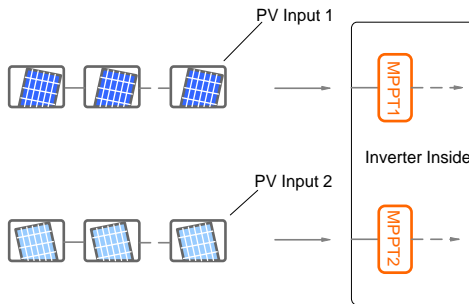

Prior to connecting the inverter to PV inputs, the specifications in the following table should be met:

Area	DC Limit Power for Each Input	Total Power Limit	DC Limit	Open-circuit Voltage Limit for Each Input	Short circuit Current Limit for Each Input
DC1	5600 W	6500 W	600 V	12 A	
DC2					

Parallel Mode

Both PV strings should have the same type, the same number of PV panels, identical tilt and identical orientation. Two trackers are configured in parallel to handle power and/or current levels higher than those a single tracker can handle.

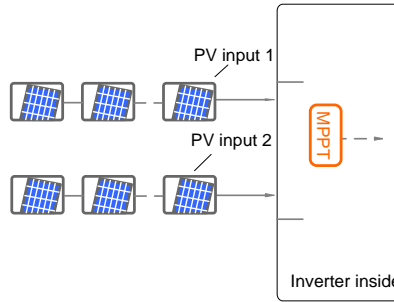

Prior to connecting the inverter to PV inputs, the specifications in the following table should be met:

Total DC Power Limit for Inverter	Open-circuit Voltage Limit for Each Input	Short circuit Current Limit for Total Input
6500 W	600 V	24 A



To avoid the power unbalance of two inputs or input load-restriction, ensure the two PV input cables are of the same type.

6.4.2 Connecting the Inverter to the PV Array

All DC cables are equipped with water-proof direct plug-in connectors, which match the DC terminals at the bottom of the inverter.

Cable Requirements

Cross-Section	Cable Diameter	Max. Withstand Voltage	Max. Withstand Current
4 mm ² ...6 mm ² AWG12...AWG10	6 mm...9 mm	600 V	Same as short circuit current.

Assembling the PV Connector

- Strip the insulation from the cables by 7 mm–8 mm.

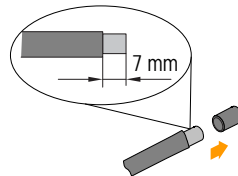

- Assemble the cable ends by crimping pliers.

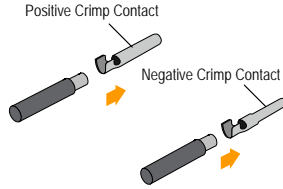

- Lead the cable through the cable gland to insert into the insulator until it snaps into place. Then tighten the cable gland (torque 2.5 N·m–3 N·m).

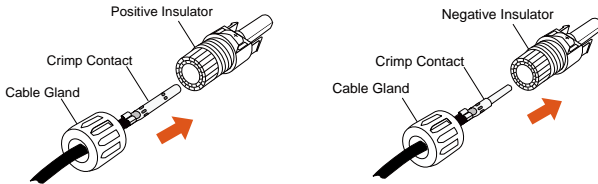

Installing the PV Connector

- Rotate the DC switch at the bottom to the “OFF” position.

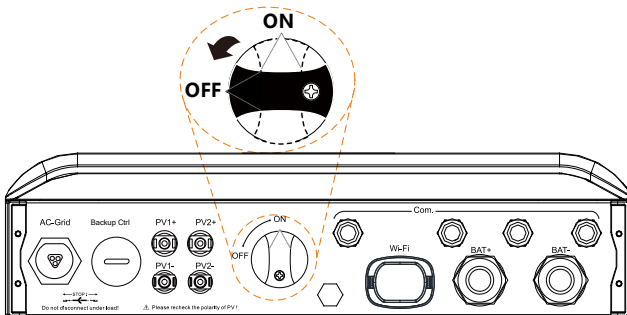

- Check the cable connection of the PV strings for the correct polarity and that the open circuit voltage does not exceed the inverter input limit of 600 V_i even under the lowest operating temperature. Refer to the module specification supplied by the module manufacturer for detailed information.

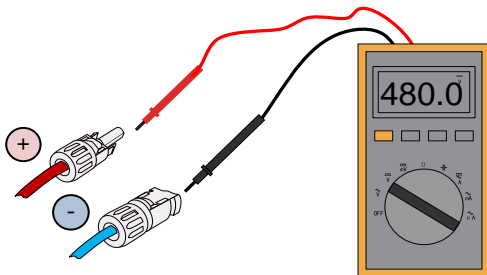

NOTICE

The inverter will not function properly if any PV polarity is reversed. If the PV connectors are not assembled into place, it may cause an arc or overheat. The loss caused by this issue will void the warranty.

3. **(Optional)** Install the copper for the parallel mode with a torque of 1.5 N·m.

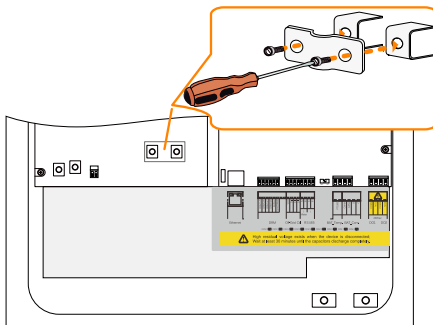

4. Plug the connectors into corresponding terminals.

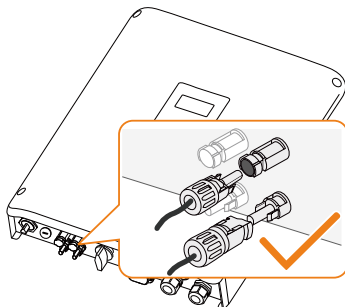

5. Seal unused DC terminals with the terminal caps.

6.5 Communication Connection

There are four ports and a Wi-Fi terminal on the bottom of the inverter, as shown in the following figure.

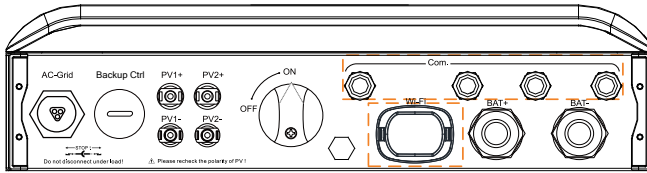

Fig. 6-3 Communication Ports and Terminal

Ethernet function:

- Through the Modbus TCP/IP protocol, the EMS or the Control Box from the third party can fully control the on/off, derating, charging and discharging of the inverter.
- The inverter operation information can be transferred via **Ethernet** port to the iSolarCloud Web. Use the iSolarCloud App or the iSolarCloud Web to access the information.
- Users can also visit Webserver to view the inverter operation information

Wi-Fi function:

With the Wi-Fi module installed, use iSolarCloud App or iSolarCloud Web to view the information.

NOTICE

The Ethernet and Wi-Fi communication can be used at the same time. However, they will be treated as two different systems by iSolarCloud server. It is recommended to use only one method in actual configuration.

6.5.1 Ethernet Connection

Connect the inverter to the PC through the **Ethernet** port to set up the Ethernet communication. The following figure shows the Ethernet connection without a router using the Browser.

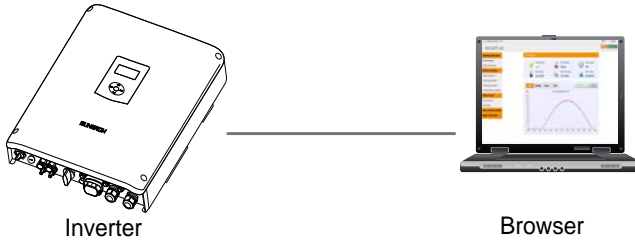

Fig. 6-4 Ethernet Connection without a Router

The following figure shows how the Ethernet connection may work with a router.

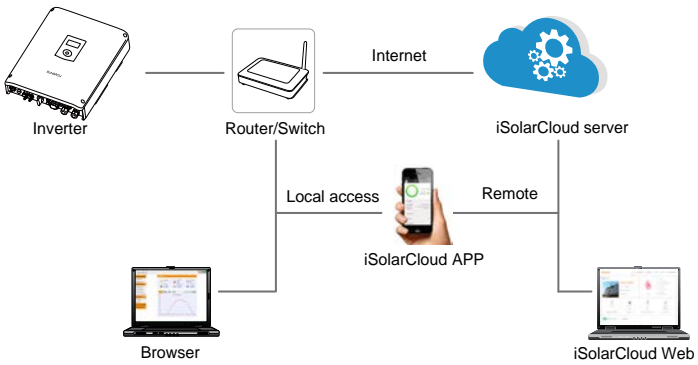

Fig. 6-5 Ethernet Connection with a Router

Cable Requirements

Use a TIA/EIA 568B standard network cable with a diameter of 3 mm–5.3 mm.

Refer to the switch/router’s manual for the definition of the communication port.

Procedure:

1. Unscrew the swivel nut from any **Com.** port.

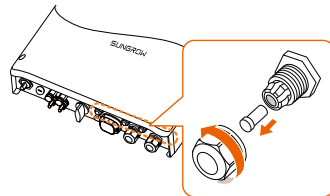

2. Lead the cable through the cable gland and remove the cable jacket by 8 mm–15 mm.

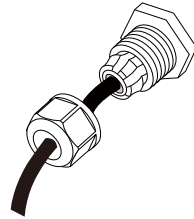

3. Use the Ethernet crimper to crimp the cable and connect the cable to RJ45 plug according to TIA/EIA 568B, as shown below.

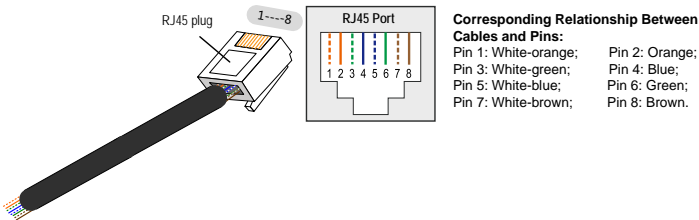

4. Install the RJ45 plug to the **Ethernet** port.
5. Fasten the swivel nut with a torque of 1 N·m–2 N·m and connect the other end to the socket of the switch or the router.

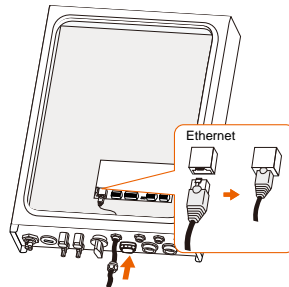

6. Set the server to [CLOUD] via the LCD menu according to the instructions in “**10.4.10 Setting the Communication Parameters**” the data will be uploaded to www.isolarcloud.com.

6.5.2 Wi-Fi Connection

1. Remove the waterproof lid from the Wi-Fi terminal.
2. Install the Wi-Fi module. Slightly shake it by hand to determine whether it is installed firmly, as shown below.

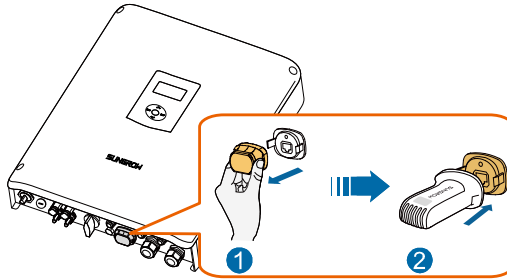

3. Refer to the quick guide for the Wi-Fi module to configure the Wi-Fi.
4. If the inverter on site has a different Wi-Fi terminal that should be compatible with the corresponding Wi-Fi module, install the Wi-Fi module as shown below.

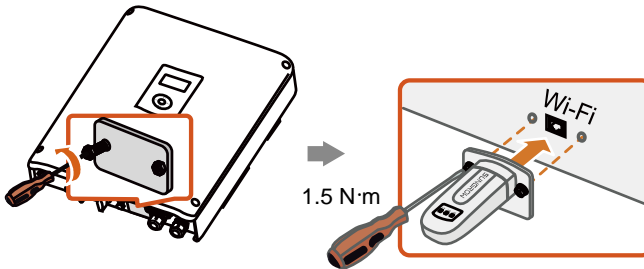

6.6 Battery Connection

This section mainly describes the cable connections on the inverter side. Refer to the instructions supplied by the battery manufacturer for the connections on the battery side.

⚠ WARNING

Only use properly insulated tools to prevent accidental electric shock or short circuits. If insulated tools are not available, use electrical tape to cover the entire exposed metal surfaces of the available tools except their tips.

6.6.1 Connecting the Power Cable

A fuse with the specification of 150 V/125 A (type: Bussmann BS88 125LET) is integrated to the **BAT-** terminal.

NOTICE

A two-pole DC circuit breaker with over-current protection (voltage rating not less than 100 V and current rating not less than 100 A) should be installed between the inverter and the battery module.

Cable Requirements

Cross-section: 16 mm²...25 mm², OT25-6, cable diameter: 13 mm...16 mm.

Procedure:

1. Remove the battery cable jacket.

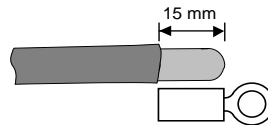

2. Crimp the OT terminal and install the heat shrinkable casing.

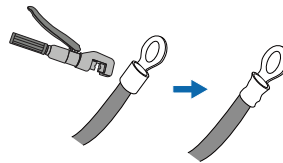

3. Unscrew the swivel nut from the **BAT+** and **BAT-** ports.

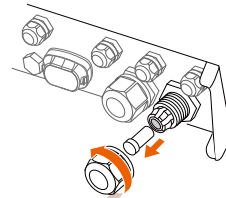

4. Lead the cable through the cable gland.

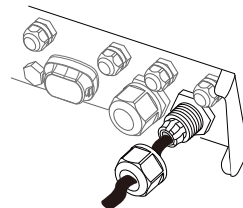

- Loosen and remove the screw sets on the **BAT+** and **BAT-** terminal blocks.
- Fasten the cables to the corresponding terminals (torque 2.6 N·m). Be sure to adhere to the following screw assembly sequence: screw head, spring washer, fender washer, OT terminal.

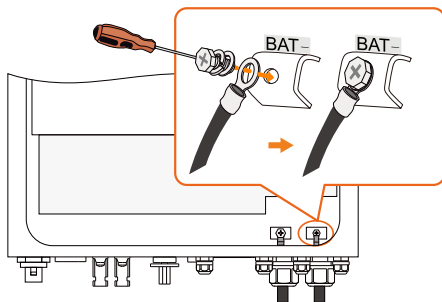

6.6.2 Connecting the CAN Cable

The CAN cable enables the communication between the inverter and the Li-ion battery from LG, GCL, Pylon (US2000B), BYD, SUNGROW or TAWAKI.

Procedure:

- Take out the CAN cable (terminal marks **CANH** and **CANL**) and the magnetic ring from the packaging.
- Unscrew the swivel nut from any **Com.** port.

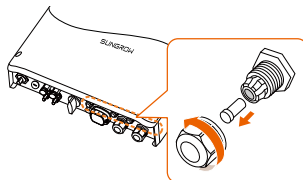

- Lead the cable through the cable gland.



4. Plug the wires into the corresponding terminals according to the marks without tool tightening.

Note:

For reconnection, press the part as shown in the red circle so as to pull out the cable.

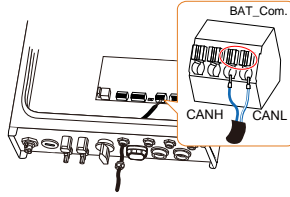

5. Fasten the swivel nut with a torque of 1 N·m–2 N·m and connect the other end to the battery.

NOTICE

For GCL and BYD batteries, if there are four wires, please cut through the green (pin 6) and white-green (pin 3) wires from the CANH and CANL terminals to set up successful communication.

6.6.3 Connecting the Temperature Sensor

When the system is equipped with a lead-acid battery, it is recommended to connect the PT1000 temperature sensor to the inverter. This is to sample the battery temperature or the external environment temperature of the battery.

Cable Requirements

Cross-section: 1.0 mm², cable diameter: 3 mm...5.3 mm

Procedure:

1. Unscrew the swivel nut from any **Com.** port.

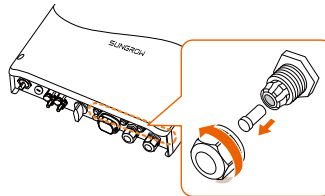

2. Lead the cable through the cable gland.

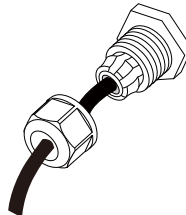

- Remove the cable jacket and strip the wire insulation.

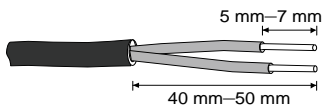

- Plug the wires into **BAT_Temp.** terminal without tool tightening.

Note:

For reconnection, press the part as shown in the red circle so as to pull out the cable.

- Fasten the swivel nut with a torque of 1 N·m–2 N·m and place the temperature sensor next to the lead-acid battery.

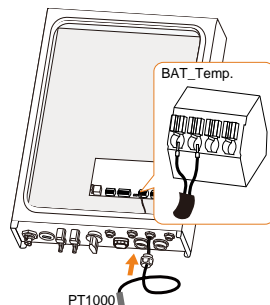

6.7 DO Connection

The inverter has two DO relays with different functions as follows:

- DO1: Consumer load control. Please choose the appropriate contactor according to the load power, e.g. the contactor types of the 3TF30 series from SIEMENS (3TF30 01-0X).
- DO2: Earth fault alarm

Relay	Trigger condition	Description
Consumer load control	The load control mode has been set via the LCD menu.	The relay is activated once the conditions of the control mode are satisfied. See “10.4.9 Setting Load Control”.
Earth fault alarm	The earth fault occurs.	Once the inverter receives the earth fault signal, the relay closes the contact. The relay remains triggered until the fault is removed.

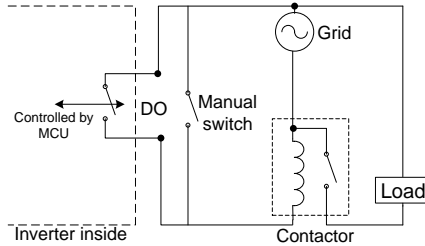

NOTICE

- An AC contactor must be installed between the inverter and appliances. It is forbidden to connect the load directly to the DO port.
- The current of the DO dry contact should not be larger than 3 A.
- The DO node is not controlled once the inverter is powered off. Connect the AC contactor by the manual switch, so as to control the loads.

Cable Requirements

Cross-section: 1.0 mm², cable diameter: 3 mm...5.3 mm

Procedure:

1. Unscrew the swivel nut from any **Com.** port.

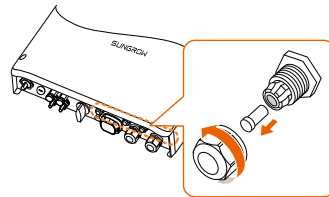

2. Lead the cable through the cable gland.

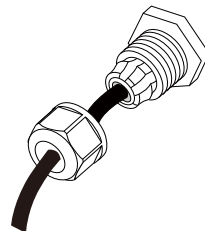

3. Remove the cable jacket and strip the wire insulation.

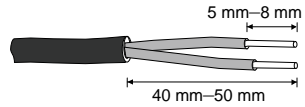

4. Plug the wires into **DO** terminals without tool tightening.
5. Note:
6. For reconnection, press the part as shown in the red circle so as to pull out the cable.

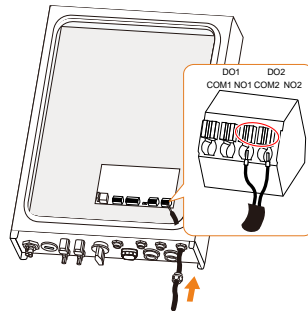

7. Fasten the swivel nut with a torque of 1 N·m—2 N·m and connect the other end of the cable to the original edge of the AC contactor.

7 Commissioning

Proper commissioning is essential for the system to protect it against fires, injury and electric shock.

7.1 Inspection before Commissioning

Check the following items before starting the system:

1. All the installation sites are convenient for operation, maintenance and service.
2. Check and confirm that the inverter is firmly installed.
3. Space for ventilation is sufficient for one inverter or multiple inverters.
4. Nothing is left on the top of the inverter or battery pack.
5. The inverter and accessories are correctly connected.
6. Cables are routed in a safe place or protected against mechanical damage.
7. The selection of the AC circuit breaker is in accordance to this manual and all applicable local standards.
8. All unused terminals at the bottom of the inverter are properly sealed.
9. Warning signs and labels are suitably affixed and durable.

7.2 Button Introduction

The inverter offers four buttons for operation. Please refer to the following table before any operation of the inverter.

Tab. 7-1 Button Functions

Button	Description
▲	For navigating up or increasing the setting value.
▼	For navigating down or decreasing the setting value.
ESC	For navigating to the left, quitting the menu or canceling the settings.
ENT	For navigating to the right or confirming a selection or settings.

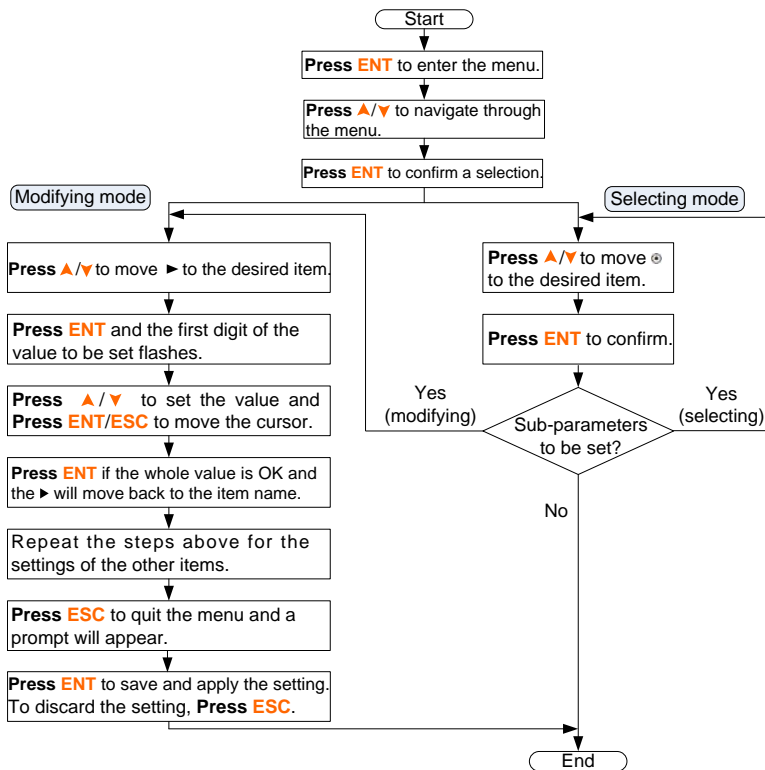

Fig. 7-1 Button Operations

7.3 Commissioning Procedure

If all the items mentioned in section 7.1 are OK, proceed as follows to start the inverter for the first time.

1. Connect the AC circuit breaker.
2. Connect the DC circuit breaker between the inverter and the battery pack.
3. **(Optional)** Power on the battery pack manually if a battery is equipped.
4. Rotate the DC switch to “ON”. The DC switch may be integrated in the inverter or installed by the customer.
5. The LCD screen will be activated 5s later and enter the initial settings.

Initial Settings 1/3	Initial Settings 2/3	Initial Settings 3/3
<ul style="list-style-type: none"> ▶ Country Time Zero-export 	<ul style="list-style-type: none"> ▶ Reactive Power Battery Usage Time Earth Fault 	<ul style="list-style-type: none"> ▶ Exit

6. Refer to **Fig. 7-1** for button operations and complete all initial settings according to the procedure in **Fig. 7-2**.

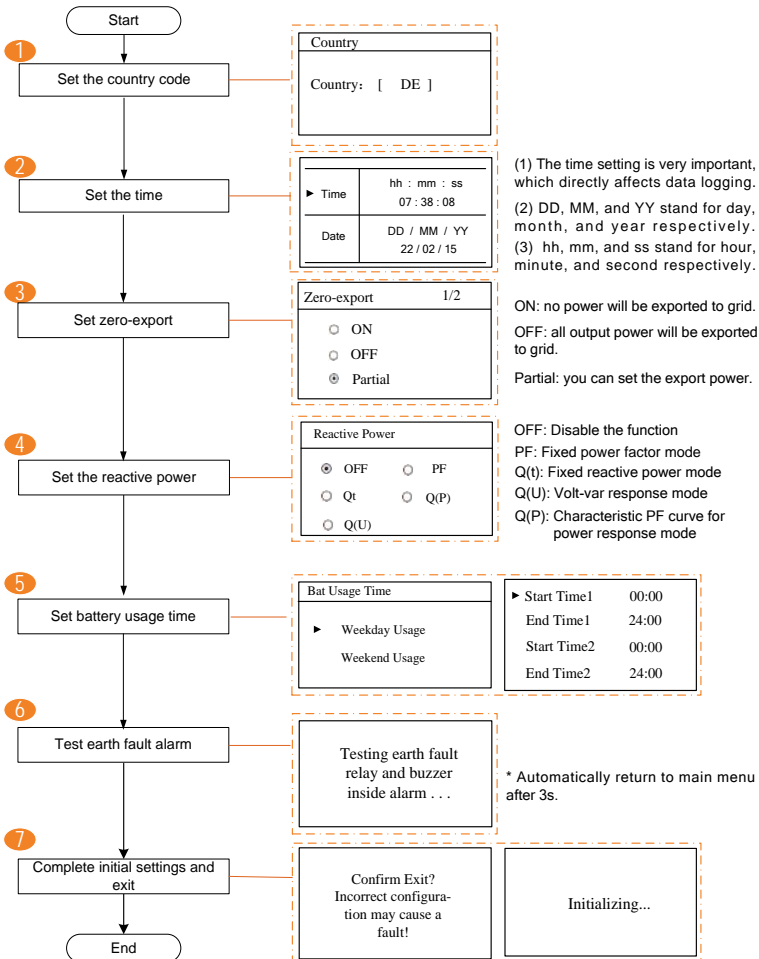

Fig. 7-2 Procedure for Initial Settings

- Zero-export (Partial):

ON: no power will be exported to the grid.

OFF: all inverter output power will be exported to the grid.

Partial: set partial of the output power to export to the grid.

According to the local regulations in Germany, please set the export power to 70 % of the installation capacity.

For example, with a total maximum installation capacity of 4600 W (SH4K6), the export power should be set to 3220 W (i.e. $4600 * 70\%$).

Export power range:

When the existing system is disabled, the range is from 0 to the rated power of the hybrid inverter.

When the existing system is enabled,

- the lower limit is the rated power of the existing PV system.
- the upper limit is ([rated power of the hybrid inverter] + [rated power of the existing PV system]).
- the value will synchronize with the settings for retrofitting an existing system described in section 10.4.2 .

- Reactive power regulation:

OFF:

The reactive power regulation function is disabled.

The power factor (PF) is limited to +1.000.

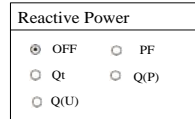
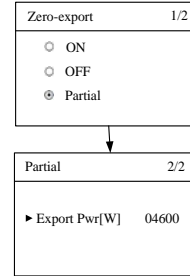

“PF” mode:

The inverter is capable of operating with fixed power factor.

The PF ranges from 0.8 leading to 0.8 lagging.

Leading: the inverter is sourcing reactive power to the grid.

Lagging: the inverter is sinking reactive power from the grid.

For the explanations of other modes, see “11 Appendix IV: Power Response”.

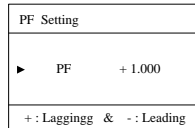

- Battery usage enabled (Weekend):

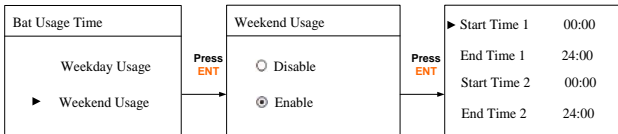

- **(Optional)** For lead-acid batteries, you should manually set the battery type.

– Turn off the inverter via the LCD menu.

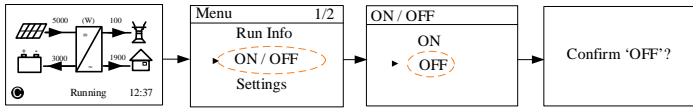

– Set the battery type to “Other Battery”.

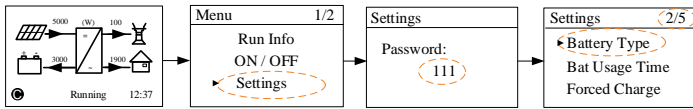

– Press ▲/▼ to select “Other Battery” and Press ENT to confirm.

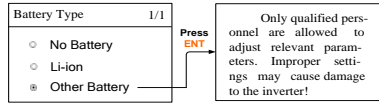

Max. Chrg / Max. DChrg:

Make sure that the charge or discharge current is not beyond the upper limit (65 A) to protect the battery from overcharging or deep discharging.

The unit **C** is the “capacity”, which refers to the maximum amount of charge that a battery can store. If the max. charge or discharge is set to more than 65 A (e.g. C = 600 Ah, 0.3C = 180 A), then the inverter will limit the charge and discharge current to 65 A.

▶ Max. Chrg	0.300 C
Max. DChrg	0.300 C
Rated Vtg	048.0 V
Capacity	0200 Ah

If the battery voltage or temperature is beyond the allowable range, the related error codes will be triggered and the protection function will be activated to stop charging or discharging.

▶ Over Vtg	58.8 V
Low Vtg	42.0 V
Over Temp	60.0 °C
Low Temp	-25.0 °C

DChrgEndVtg:

Stop discharging at a voltage not lower than DChrgEndVtg, so as to protect the battery from deep discharging.

The **DChrgEndVtg** setting value should be higher than the **Low Vtg** setting value.

▶ CSTVtgChrg	56.40 V
DChrgEndVtg	43.20 V

Tab. 7-2 Parameter Description for Other Battery

Parameter	Description	Range
Max. Chrg	The upper limit of the charging current	0.05C...2C
Max. DChrg	The upper limit of the discharging current	0.1C...2C
Rate Vtg	The rated voltage of the equipped battery	30 V...60 V
Capacity	Capacity of the battery tray	10 Ah...1000 Ah
Over Vtg	The upper limit of battery voltage when charging	48 V...70 V

Parameter	Description	Range
Low Vtg	The lower limit of battery voltage when discharging	32 V...48 V
Over Temp	The upper limit of battery temperature	20°C...70°C
Low Temp	The lower limit of battery temperature	-30°C...10°C
CSTVtgChar	The voltage of constant-voltage charging.	40 V...63 V
DChrgEndVtg	The voltage at which the discharging is stopped	30 V...53 V

* Consult battery manufacturer for an advice before any modification.

7. Check and confirm the communication method. Refer to “**10.4.10 Setting the Communication Parameters**” for the communication configuration. Use the iSolarCloud APP to create a new plant. For details, refer to the User Guidance of iSolarCloud APP.
8. Check the icons on the main screen. Refer to “**10.1 Main Screen**” for the explanations.

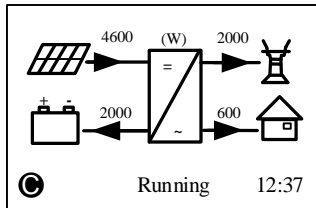

9. Check the status of the indicator.

Tab. 7-3 Status Descriptions of the Indicator

Color	Status	Description
Green	On	The inverter is running normally.
	Blinking	The inverter is in the process of starting.
	Off	Other statuses except Running and Startup. (Refer to Tab. 10-1 for status descriptions.)
Red	On	Permanent fault or upgrade failure.
	Blinking	Other system faults or main alarms.
	Off	No fault occurs.

10. Visit www.isolarcloud.eu or iSolarCloud App to view inverter information. Get the related manuals at www.sungrowpower.com.

If the inverter commissioning fails, **Press ▼** to view the current errors. Remove the existing malfunctions and then repeat starting up the inverter according to the procedure detailed in this section.

NOTICE

In the case of commissioning failure, power off the system and wait 1 minute to commission the system again.

7.4 Result Verification

7.4.1 Energy Meter Installation and Connection

For the single-phase Energy Meter, with the signal from the 1-phase sensor, the inverter determines the energy exchange with the utility grid on one phase. The CT clamp of 1-phase sensor can be placed before or after the main switch.

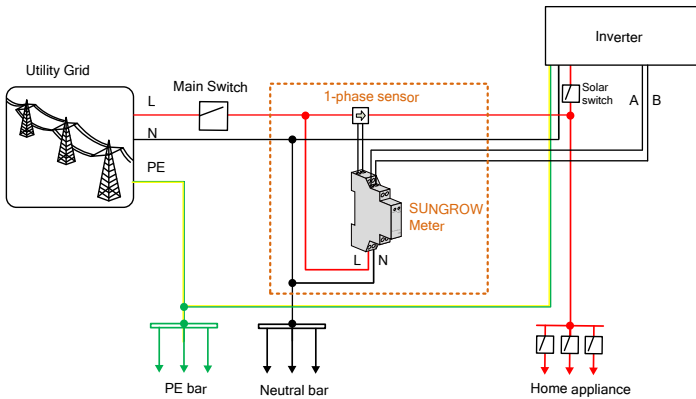

Fig. 7-3 Correct Installation and Connection of the Single-phase Energy Meter

The following figure shows the correct installation and connection of the three-phase Energy Meter.

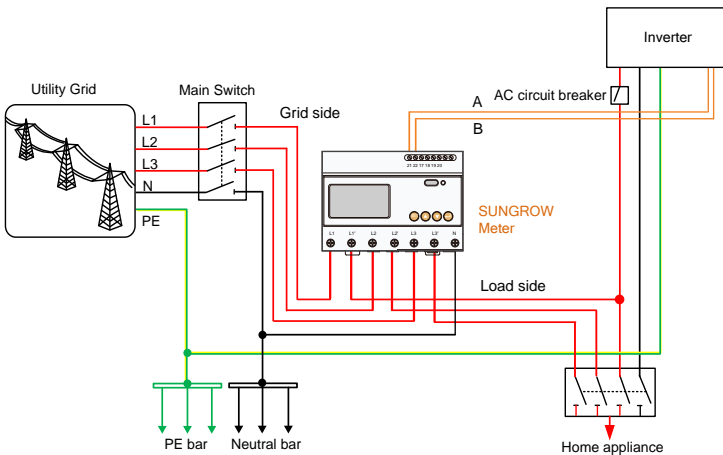
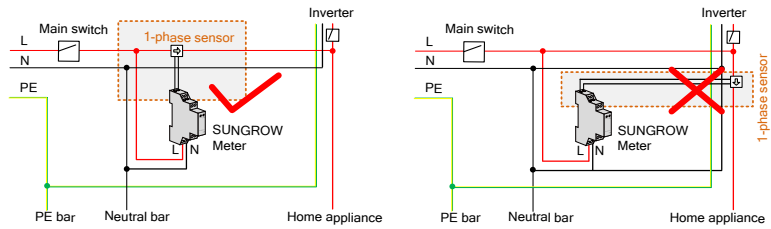

Fig. 7-4 Correct Installation and Connection of the Three-phase Energy Meter

Before the verification, disconnect the DC switch between the inverter and the battery module.

For Incorrect Installation Position

Make sure that the 1-phase sensor of the Sungrow Energy Meter should be placed to the phase line (L) from the main switch. If otherwise, the energy flow indicated on the LCD will be wrong.



Action	LCD Explanation
Turn off all the household loads. All the PV power generation should be exported to the grid, as shown in the "Correct" figure.	<div style="display: flex; justify-content: space-around;"> <div style="text-align: center;"> <p>Correct</p> </div> <div style="text-align: center;"> <p>Wrong</p> </div> </div>

For Reverse Sensor Connection

Make sure that the arrow on the 1-phase sensor must point away from the grid towards the load. If otherwise, the energy flow indicated on the LCD will be wrong.

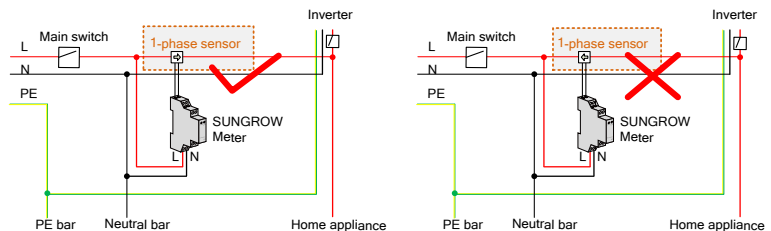

Fig. 7-5 Correct CT Installation for Single-phase Energy Meter

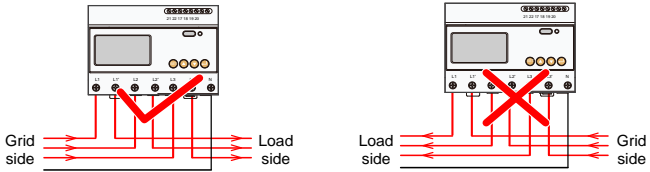

Fig. 7-6 Correct Power cable connection for Three-phase Meter

Action	LCD Explanation	
<p>Method 1: Turn off all the household loads. All the PV power generation should be exported to the grid, as shown in the “Correct” figure.</p>	<p>Correct</p> <p>Running 12:37</p>	<p>Reverse</p> <p>Running 12:37</p>
<p>Method 2: Stop the inverter via the LCD menu and turn on the household loads. All the load power consumption should be imported from the grid, as shown in the “Correct” figure.</p>	<p>Correct</p> <p>Turn off 12:37</p>	<p>Reverse</p> <p>Turn off 12:37</p>

NOTICE

The reverse sensor connection will cause the communication fault 084. To clear the fault 084, please turn off the DC sources and then restart the system after reconnecting the sensor in correct direction.

7.4.2 Battery Information

After initial settings, check the detailed battery information on the LCD display.

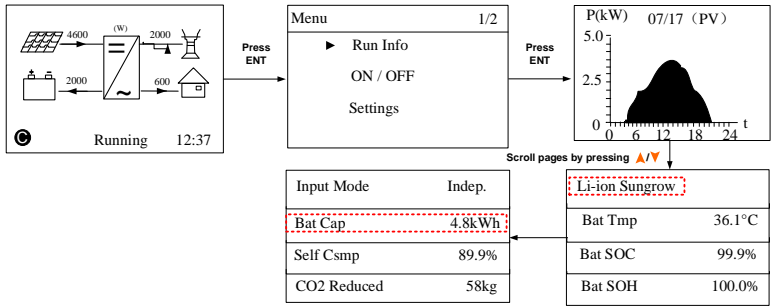

If the battery type or capacity setting is inconsistent with the actual, the charge/discharge current may be less than the actual charge/discharge ability. However, the system can operate normally. Proceed as follows to modify.

1. Stop the inverter via the LCD menu.
2. Reset the battery type and parameters. Proceed as follows to enter the submenu.
3. Start the inverter via the LCD menu.

7.4.3 System Time

The correct system time is very important. If there is deviation between the system time and the local time, the inverter will not operate normally. The clock is in 24-hour format. Proceed as follows to set the correct time.

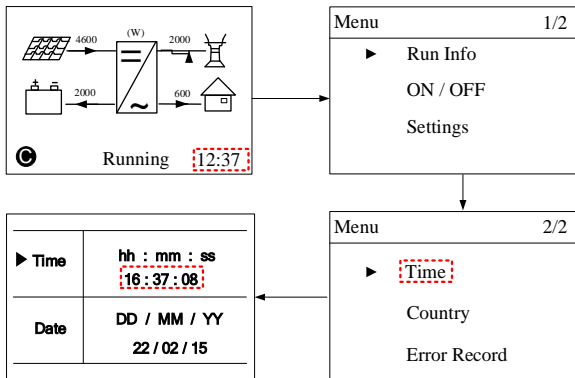

8 Troubleshooting and Maintenance

8.1 Troubleshooting

8.1.1 LED Indicator

See “Tab. 7-3 Status Descriptions of the Indicator” for the definition.

Fault Type	Troubleshooting
The indicator and LCD screen cannot be lit.	<ol style="list-style-type: none">1. Disconnect the AC circuit breaker.2. Rotate the DC Switch to “OFF”.3. Check the polarities of the DC inputs.4. If all of the above are OK, please contact SUNGROW.
The indicator goes out from green.	<ol style="list-style-type: none">1. Disconnect the AC circuit breaker.2. Rotate the DC Switch to “OFF”.3. Check the electrical connection.4. Check whether the DC input voltage exceeds the start voltage of the inverter.5. If all of the above are OK, please contact SUNGROW.
The indicator is lit red.	<ol style="list-style-type: none">1. A fault is not resolved.2. Perform troubleshooting according to the fault type on the LCD screen. See “8.1.2 Errors on the App or LCD Screen”.3. If the fault persists, please contact SUNGROW.

8.1.2 Errors on the App or LCD Screen

When an error occurs, the “Error” state will be shown on the main screen.

Press ▼ to view all the error information.

- For the battery error codes, if all the conditions are OK but the error still occurs, contact the distributor or the battery manufacturer.
- We need the following information to provide you with the best assistance: inverter type (e.g. string, central, grid-connected, hybrid, transformerless, single phase, triple phase, single MPPT, multiple MPPTs), or product name, serial number of the inverter, error code / name, and a brief description of the problem.

For Inverter Side

Code	Specification	Troubleshooting
002	Grid over-voltage. (default range: 264.5 V)	1. Check the grid voltage. 2. If the grid voltage exceeds the permissible range, consult the utility grid for a solution.
003	Temporary grid over-voltage in the on-grid mode. (default value: 400 V)	This is a short-term fault. Wait a moment for inverter recovery or restart the system.
004	Grid under-voltage. (default range: 184.0 V...195.5 V)	1. Check the grid voltage. 2. If the grid voltage exceeds the permissible range, consult the utility grid for a solution.
005	Grid under-voltage. (default value: 195.5 V)	
007	Temporary AC over-current. The transient AC current has exceeded the allowable upper limit.	Wait a moment for inverter recovery or restart the system.
008	Grid over-frequency. (default range: 50.5 Hz...51.5 Hz)	1. Check the grid frequency. 2. If the grid frequency exceeds the permissible range, consult the utility grid for a solution.
009	Grid under-frequency. (default range: 47.5 Hz...49.5 Hz)	
010	Islanding. Abnormal connection between the system and the grid.	1. Check whether the AC circuit breaker is triggered. 2. Check whether all the AC cables are firmly connected. 3. Check whether the grid is in service.
011	DC injection over-current. The DC injection of the AC current exceeds the upper limit.	Wait a moment for inverter recovery or restart the system.
012	Leakage current over-current. The leakage current exceeds the upper limit.	1. Check whether there is a grounding fault in the PV strings. 2. Wait a moment for inverter recovery or restart the system.
014	10-minute grid over-voltage. The average grid voltage is outside the permissible range for over 10 minutes. (default range: 253.0 V...257.6 V)	1. Check whether the grid is operating normally. 2. Wait a moment for inverter recovery or restart the system.
015	Grid over-voltage. (default value: 264.5 V)	1. Check the grid voltage. 2. If the grid voltage exceeds the permissible range, consult the utility grid for a solution.

Code	Specification	Troubleshooting
019	Bus over-voltage. The transient bus voltage exceeds the upper limit.	Wait a moment for inverter recovery or restart the system.
021	PV1 over-current. The input current of PV1 exceeds the upper limit.	1. Check the PV input power and configuration.
022	PV2 over-current. The input current of PV2 exceeds the upper limit.	2. Wait a moment for inverter recovery or restart the system.
024	Neutral point voltage imbalance. The deviation of the neutral point voltage exceeds the allowable limit.	1. The inverter will recover once the deviation falls below the protective limit. 2. Wait a moment for inverter recovery or restart the system.
028	Reverse polarity of the PV1 connection.	1. Disconnect the DC switch. 2. Check the polarity of the PV inputs.
029	Reverse polarity of the PV2 connection.	3. Reconnect the PV strings if the polarity is incorrect.
037	Inner over-temperature fault. The ambient temperature inside the inverter exceeds the upper limit.	1. Check and clean the heat sink. 2. Check whether the inverter is installed in sunlight or the ambient temperature of the enclosure exceeds 45 °C . If not, please contact SUNGROW for a solution.
038	Relay fault on the grid side.	Wait 5 minutes for inverter recovery or restart the system.
041, 622	Leakage current sampling fault.	Wait 5 minutes for inverter recovery or restart the system.
043	Inner under-temperature fault. The ambient temperature inside the inverter is too low	The inverter will recover once the ambient temperature rises above -25°C.
044	INV open-loop self-check fault.	
045	PV1 boost circuit fault.	Wait 5 minutes for inverter recovery or restart the system.
046	PV2 boost circuit fault.	
048	Phase current sampling fault.	
051	Load overpower fault in the off-grid mode.	If the fault persists, disconnect some non-key loads.
052	INV under-voltage fault in the off-grid mode.	Wait 5 minutes for inverter recovery or restart the system.
062	DI fault of the backup box STB5K.	1. Check whether the DI connection between the inverter and the backup box is correct. 2. Wait 5 minutes for inverter recovery.
063	The version of CPLD (complex	Power off the system and program

Code	Specification	Troubleshooting
	programmable logic device) cannot be detected.	the CPLD
064	INV over-voltage fault in the off-grid mode.	
065	INV under-frequency fault in the off-grid mode. (default value: 47 Hz)	
066	INV over-frequency fault in the off-grid mode. (default value: 52 Hz)	Wait 5 minutes for inverter recovery or restart the system.
067	Temporary grid over-voltage in the off-grid mode. (default value: 500 V)	
083	Fan2 abnormal speed warning.	1. Check if the fan is blocked. 2. Restart the system.
084	Warning for reverse cable connection of the Sungrow Energy Meter.	1. Check whether the power cable connections are correct. 2. For Sungrow single-phase Energy Meter, check whether the CT clamp of the 1-phase sensor is correctly placed. Refer to "7.4.1 Energy Meter Installation and Connection".
100	INV hardware over-current fault. The AC current exceeds the protective value.	Wait 5 minutes for inverter recovery or restart the system.
101	Grid over-frequency. (default value: 51.5 Hz)	
102	Grid under-frequency. (default value: 47.5 Hz)	Check the grid frequency.
105	SPI auto test fault (for Italy only)	1. Clear the fault via the LCD menu. 2. Restart the system and re-do the auto test if necessary. 3. If the fault persists, please contact SUNGROW for a solution.
106	Earth fault. Neither the PE terminal on the AC connection block nor the second PE terminal on the enclosure is reliably connected.	1. Check whether there is a reliable grounding connection. 2. Check whether the L-line and N-line are connected correctly. 3. If there is access to the ground, and the fault still exists, please contact SUNGROW for a solution.
107	DC injection over-voltage fault in the off-grid mode. The DC injection of INV voltage exceeds the upper limit.	The inverter will recover once the DC injection voltage falls below the recovery value.

Code	Specification	Troubleshooting
200	Bus hardware over-voltage fault. The bus voltage exceeds the protection value.	Wait 5 minutes for inverter recovery or restart the system.
201	Bus under-voltage fault.	
202	PV hardware over-current fault. The PV1 or PV2 current exceeds the protective value.	Check the functionality of the PV connection terminals.
203	The PV input voltage exceeds the bus voltage.	
204	PV1 boost short-circuit fault	The inverter may be damaged. Contact SUNGROW for a solution.
205	PV2 boost short-circuit fault	
300	INV over-temperature fault.	<ol style="list-style-type: none"> 1. Check and clean the heat sink. 2. Check whether the inverter is installed in sunlight or the ambient temperature of the enclosure exceeds 45°C...60°C. 3. Restart the system.
302	PV insulation resistance fault.	<ol style="list-style-type: none"> 1. Check whether the PV cable connection is intact. 2. Wait for a sunny day to check whether the system can run well.
308	Slave DSP redundant fault.	Restart the system.
309	Phase voltage sampling fault.	
312	DC injection sampling fault.	
315	PV1 current sampling fault.	
316	PV2 current sampling fault.	
317	PV1 MPPT current sampling fault.	
318	PV2 MPPT current sampling fault.	
319	System power supply failure fault.	
320	Leakage current CT self-check fault.	
321	SPI communication failure. Communication faults between the master DSP and the slave DSP.	
322	Master DSP communication fault.	
401... 408	Permanent faults.	
409	All temperature sensors failed fault.	
501	FRAM1 reading warning.	<ol style="list-style-type: none"> 1. Inverter can normally be connected to the grid. 2. Restart the system.
503... 506,	Temperature sensor warnings.	

Code	Specification	Troubleshooting
511		
507	Error alarm of DO power settings.	Modify the DO control power according to the load power. Refer to " Optimized Control " in the user manual.
509	Clock reset fault.	Manually reset the clock or synchronize the clock with the network time. This will clear the fault.
510	PV over-voltage fault.	<ol style="list-style-type: none"> 1. Check whether the configuration of the PV array exceeds the permissible range of the inverter. 2. Wait a moment for inverter recovery or restart the system.
513	Fan1 abnormal speed warning.	<ol style="list-style-type: none"> 1. Check if the fan is blocked. 2. Restart the system.
514	Abnormal communication warning of the Sungrow Energy Meter. (Inverter can be normally connected to the grid.)	<ol style="list-style-type: none"> 1. Check whether the power cable connections of the Energy Meter are correct. 2. Check whether the RS485 connection is correct. 3. Check if the 120 Ohm (2) resistor for RS485_2 is pushed to "ON" when the length of RS485 cable is longer than 100 m.
600	Temporary BDC charging over-current fault.	Wait a moment for system recovery or restart the system.
601	Temporary BDC discharging over-current fault.	
602	Clamping capacitor under-voltage fault.	<ol style="list-style-type: none"> 1. Check the cable connection of the battery. 2. Wait a moment for system recovery or restart the system.
603	Temporary clamping capacitor over-voltage fault.	Wait a moment for system recovery or restart the system.
608	BDC circuit self-check fault.	
612	BDC over-temperature fault.	<ol style="list-style-type: none"> 1. Check and clean the heat sink. 2. Check whether the inverter is installed in sunlight or the ambient temperature of the enclosure exceeds 45°C. 3. Restart the system.
616	BDC hardware over-current fault.	The system will resume once the battery charge/discharge current falls below the upper limit or restart the system.
620	BDC current sampling fault.	Wait a moment for system

Code	Specification	Troubleshooting
623	Slave DSP communication fault.	recovery or restart the system.
624	BDC soft-start fault.	
800,802 804,807	BDC internal permanent faults.	Restart the system
900,901	BDC temperature sensor warnings	<ol style="list-style-type: none"> 1. Check and clean the heat sink. 2. Check whether the inverter is installed in sunlight or the ambient temperature of the enclosure exceeds 45°C. 3. Restart the system.
906	Transformer recognition error.	direction <ol style="list-style-type: none"> 1. The inverter can normally be connected to the grid but charge/discharge has stopped. 2. Wait a moment for system recovery or restart the system.
910	FRAM2 warning	Restart the inverter.

For Battery Side

For the battery faults, please consult the battery manufacturer for a solution.

Code	Specification	Troubleshooting
703	Battery average under-voltage fault.	<ol style="list-style-type: none"> 1. The inverter can normally be connected to the grid but charge/discharge has stopped. 2. Wait a moment for system recovery or restart the system.
707	Battery over-temperature fault.	<ol style="list-style-type: none"> 1. The inverter can normally be connected to the grid but charge/discharge has stopped. 2. Check the ambient temperature of the battery location. 3. Wait a moment for system recovery or restart the system.
708	Battery under-temperature fault.	<ol style="list-style-type: none"> 1. The inverter can normally be connected to the grid but charge/discharge has stopped. 2. Wait a moment for system recovery or restart the system.
711	Instantaneous battery over-voltage.	<ol style="list-style-type: none"> 1. The inverter can normally be connected to the grid but charge/discharge has stopped. 2. Wait a moment for system recovery or restart the system.
712	Battery average over-voltage fault.	<ol style="list-style-type: none"> 1. The inverter can normally be connected to the grid but charge/discharge has stopped. 2. Check the battery type and communication connection. For lead-acid batteries, you should manually set the battery type. 3. Wait a moment for system recovery
714	Abnormal communication between battery and the hybrid inverter.	

Code	Specification	Troubleshooting
715	Battery hardware over-voltage fault.	or restart the system. 1. The inverter can normally be connected to the grid but charge/discharge has stopped. 2. Wait a moment for system recovery or restart the system.
732	Battery over-voltage protection.	1. The inverter can normally be connected to the grid. Charge has stopped but discharge is allowed. 2. Wait a moment for system recovery.
733	Battery over-temperature protection.	1. The inverter can normally be connected to the grid but charge/discharge has stopped.
734	Battery under-temperature protection.	2. Check the ambient temperature of the battery location. 3. Wait a moment for system recovery or restart the system.
735	Battery charging/discharging over-current protection.	1. The inverter can normally be connected to the grid but charge/discharge has stopped. 2. Wait a moment for system recovery or restart the system.
739	Battery under-voltage protection.	1. The inverter can normally be connected to the grid. Discharge has stopped but charge is allowed. 2. Wait a moment for system recovery or restart the system.
832	Battery FET fault or electrical switch failure.	1. The inverter can normally be connected to the grid but charge/discharge has stopped.
834	Battery charging/discharging over-current permanent fault.	2. Check the battery port voltage and the battery communication cable connection. 3. Force a shutdown and restart the inverter and battery system. 4. Wait a moment for system recovery or restart the system.
836	ID competing failure.	Restart the system, if the fault persists, please contact SUNGROW for a solution.
839	Mismatched software version.	Contact SUNGROW for a solution.
844	Software self-verifying failure.	Restart the system, if the fault persists, please contact SUNGROW for a solution.
864	Battery cell over-voltage fault.	1. The inverter can normally be connected to the grid but charge / discharge has stopped.

Code	Specification	Troubleshooting
		2. Wait a moment for system recovery or restart the system.
866	Battery precharge voltage fault.	1. The inverter can normally be connected to the grid but charge/discharge has stopped.
867	Battery under-voltage fault.	2. Check the battery port voltage and the battery communication cable connection.
868	Battery cell voltage imbalance fault.	3. Force a shutdown and restart the inverter and battery system.
870	Battery cable connection fault.	4. Wait a moment for system recovery or restart the system.
909	Low SOH (State of Health) warning.	1. The inverter can normally be connected to the grid and the charge/discharge function is normal. 2. Batteries are beyond the scope of the warranty. It is recommended to contact the distributor for replacements.
932	Battery over-voltage warning.	1. The inverter can normally be connected to the grid. Charge has stopped but discharge is allowed. 2. The system will resume after a certain time of discharging.
933	Battery over-temperature warning.	1. The inverter can normally connected be to the grid but charge/discharge has stopped.
934	Battery under-temperature warning.	2. Check the ambient temperature of the battery location. 3. Wait a moment for system recovery or restart the system.
935	Battery charging/discharging over-current warning.	1. The inverter can normally be connected to the grid but charge/discharge has stopped. 2. Wait a moment for system recovery or restart the system.
937	Battery tray voltage imbalance warning.	1. The inverter can normally be connected to the grid and the charge/discharge functions are normal. 2. Check whether the cable connection of the battery is correct.
939	Battery under-voltage warning.	1. The inverter can normally be connected to the grid. Discharge has stopped but charge is allowed. 2. The system will resume after a certain time of charging.
964	Battery internal warning.	Consult the battery manufacturer for a solution.

8.2 Maintenance

8.2.1 Routine Maintenance

Item	Method	Period
General status of the system	<ul style="list-style-type: none"> • Visual check for any damage or deformation of the inverter. • Check any abnormal noise during the operation. • Check each operation parameter. • Be sure that nothing covers the heat sink of the inverter. 	Every 6 months
Electrical connection	Check whether there is damage to the cables, especially the surface in contact with metal.	6 months after commissioning and then once or twice a year.

8.2.2 Replacing the Button Cell

DANGER

Disconnect the AC circuit breaker and then set the DC load-break switch of the inverter to OFF, then disconnect the inverter from the battery before any maintenance work.

Lethal voltage still exists in the inverter. Please wait at least 10 minutes and then perform maintenance work.

There is a button cell on the inner PCB board of the LCD. Contact SUNGROW for replacement when the relevant fault alarm occurs.

Check the fastener, appearance, voltage, and resistance quarterly and annually.

9 System Decommissioning

9.1 Decommissioning the Inverter

NOTICE

Please strictly follow the following procedure. Otherwise it will cause lethal voltages or unrecoverable damage to the inverter.

Powering off the Inverter

1. Stop the inverter via the LCD menu. For details, see “**10.3 Starting and Stopping the Inverter**”.
2. Disconnect the AC circuit breaker and secure it against reconnection.
3. Rotate the DC switch to “OFF”. The DC switch may be integrated on the inverter bottom or installed by the customer.
4. Disconnect the DC circuit breaker between the battery and the inverter.



CAUTION

Risk of burn injuries and electric shock!

Do not touch any inner live parts until 10 minutes after disconnecting the inverter from the utility grid, the PV inputs and the battery module.

NOTICE

Do not power on the system again until 1 minute after the disconnection.

5. Wait for about **10** minutes until the capacitors inside the inverter have completely discharged.
6. Measure and ensure that no voltage is present at the AC output on the inverter.
7. Refer to “**6.3 Grid Connection**” to disconnect the AC connector from the inverter in reverse procedure.
8. Release the locking part of DC connectors by pressing on the ribbing of the locking hooks with nipper pliers and pull it outwards.
9. Use the multimeter to measure the port voltage of the battery. Disconnect the power cables after the voltage is zero.

Dismantling the Inverter

Refer to **Chapter 4** and **Chapter 5** to dismantle the cables in reverse procedure. Remove the wall-mounting bracket from the wall if necessary.

Disposing of the Inverter

Users take the responsibility for the disposal of the inverter.

NOTICE

Some parts and devices of the inverter, such as LCD panel, batteries, capacitors, may cause environment pollution.

Do not dispose of the product together with household waste but in accordance with the disposal regulations for electronic waste applicable at the installation site.

9.2 Decommissioning the Battery

Decommission the battery in the system after the inverter is decommissioned. Proceed as follows to decommission a Li-ion battery or lead-acid battery.

SUNGROW is not liable for disposal of the battery.

Decommissioning Li-ion Battery

1. Disconnect the DC circuit breaker between the battery and the inverter.
2. Disconnect the communication cable between the battery and the inverter.
3. **(Optional)** Turn off the switch on LG Li-ion battery or Pylon Li-ion battery, if applicable.
4. Wait for about 1 minute and then use the multimeter to measure the port voltage of the battery.
5. If the battery port voltage is zero, disconnect the power cables from the battery module.

Decommissioning Lead-acid Battery

1. Disconnect the DC switch between the battery and the inverter.
2. Turn off the switch on the battery.
3. Disconnect all the cables from the battery.

10 Appendix II: LCD Operation

Refer to Fig. 7-1 for button operations when setting parameters.

10.1 Main Screen

After successful commissioning, the LCD screen will enter the main screen.

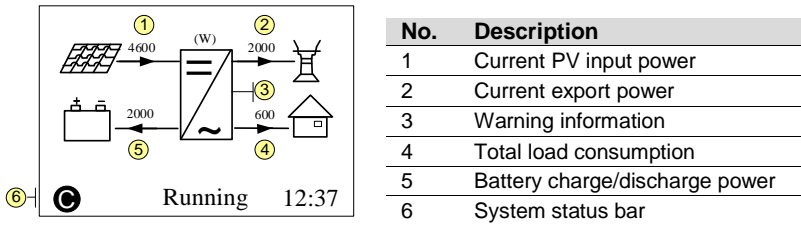

Ⓢ: The inverter and the iSolarCloud server are successfully connected.

Running: The inverter is in its normal running status.

16:37: Current system time.

Neither the grid power nor the load power will be displayed on the main screen in case of no Sungrow Energy Meter installed. The Wi-Fi icon may be not displayed when the inverter is used with some Wi-Fi modules.



If there is no button operation for:

- 1 minute, the LCD backlight is OFF;
- 2 minutes, system returns to the default menu (main screen).

Tab. 10-1 Status Descriptions

Status	Description
Running	After being energized, the inverter tracks the PV array's maximum power point (MPP) and runs with the combination of the energy management system. This mode is the normal mode.
Maintain	The system is running normally, with the battery in maintenance process. (Only for lead-acid battery)
Forced	The system is running normally, with the EMS in forced mode.

Status	Description
Standby	The inverter waits for sufficient sunlight or battery level, then the DC voltage recovers. The standby time can be set via the iSolarCloud App or the iSolarCloud server.
Turn off	The inverter will stop running by manual "OFF" through the LCD menu. Set to "ON" if you want to restart the inverter.
Startup	The inverter is initializing and synchronizing with the grid.
Upgrade	The DSP or LCD firmware is in its upgrading process.
Error	If an error occurs, the inverter will automatically stop operation, trigger the AC relay and show "Error" on the LCD with the indicator lit red.
Upd-fail	The master DSP program online upgrade failure.

NOTICE

If the inverter is in standby mode for more than 10 minutes, please check:

- **Whether the insolation is sufficient and the PV connection is correct.**
- **Whether the battery level is sufficient and the cable connection is correct.**
- **If no anomaly is found, disconnect and connect the DC switch and the main switch to restart.**
- **If it still does not work, contact SUNGROW.**

10.2 LCD Menu Structure

Abbreviations

Abbreviation	Complete	Abbreviation	Complete
Csmp	Consumption	Exp	Export
Chrg	Charge	Tot	Total
Bat	Battery	Tmp	Temperature
SOC	State of Charge	SOH	State of Health
Vtg	Voltage	Curr	Current
Stt	State	Inv	Inverter
Pwr	Power	Frq	Frequency
Cap	Capacity	DRM	Demand respond mode
Ver.	Version	Ref.	Reference
CSTVtgChrg	Constant charging voltage	MDCV	Max. discharging current value
DChrg	Discharge	MCCV	Max. charging current value
Prot.	Protection	Multi.	Multiple

Abbreviation	Complete	Abbreviation	Complete
Comm.	Communication	DChrgEndVtg	Final discharge voltage
Sys	System	En.	Enable

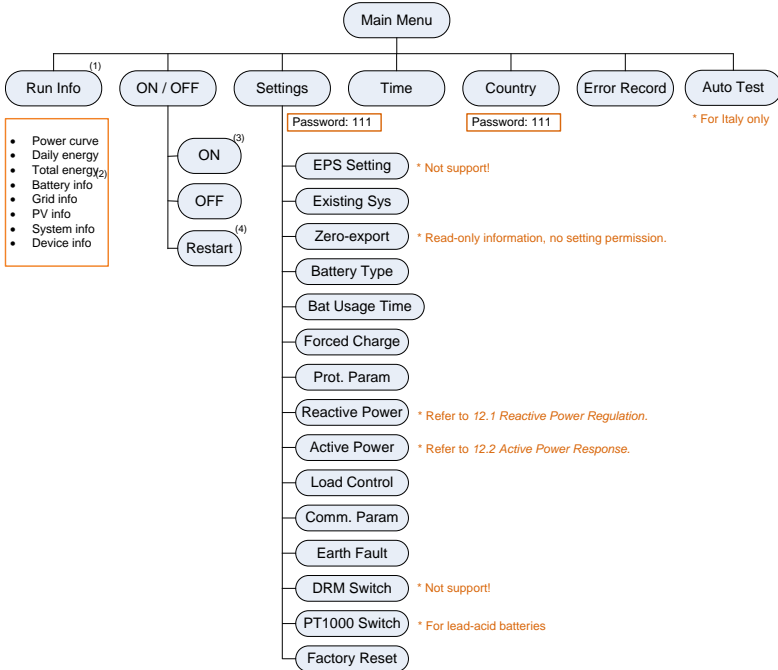

Fig. 10-1 LCD Menu Tree

- The power value indicated represents the average value during the time interval. The energy yields displayed are indicative only. For the actual yields, please refer to the electric energy meter.
- The value of battery SOH will be displayed as "--" for GCL batteries since they do not have this parameter.
- The "Restart" option will appear only if an unrecoverable fault occurs.

10.3 Starting and Stopping the Inverter

Notice:

The Restart item will appear only if an unrecoverable fault occurs.

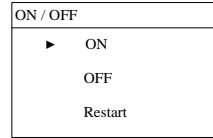

Confirm your choice by pressing **ENT**.

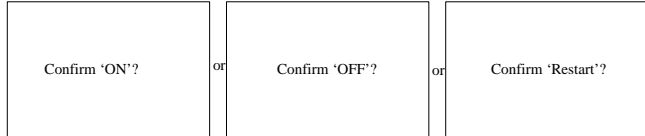

10.4 Advanced Settings

10.4.1 Inputting Password

The parameter settings are protected with a password. If you want to set the inverter's parameters, you have to input the correct password.

Press ▲ to add the value and **Press ENT** to move the cursor to input the password **111**. **Press ENT** to confirm the password and enter the submenu.

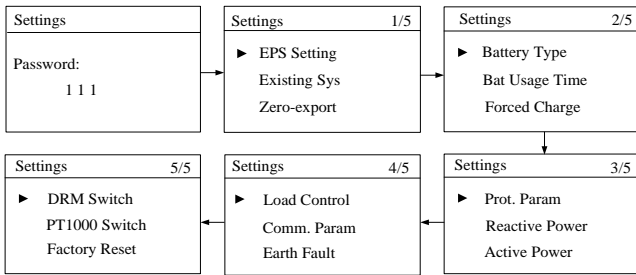

10.4.2 Adding the Existing System

Existing Sys Rated-P:
rated power of the existing system.

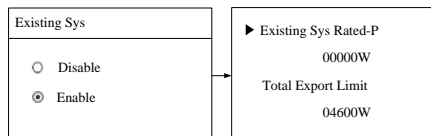

Total Export Limit: the export power limit of the new system

- The lower limit is the rated power of the existing PV system.
- The upper limit is ([rated power of the hybrid inverter] + [rated power of the existing PV system]).

For example, retrofit an existing PV system (rated power: 3000 W) with the hybrid inverter SH4K6 (rated power: 4600 W). The total export limit can be set from 3000 W to 7600 W.

The export power limit can also be set via the Zero-export menu that described in the commissioning. The settings in the two submenus are from the same source. If one is changed, the other will synchronize the value.

10.4.3 Setting the Battery Type

For Li-ion batteries, the type can be automatically identified and set to “Li-ion” on the LCD. Manually set the type to “Other Battery” for lead-acid batteries. Proceed as follows to modify the settings.

Refer to “10.3 Starting and Stopping the Inverter” to stop the inverter before modifying the battery type. Otherwise the warning screen will prompt.

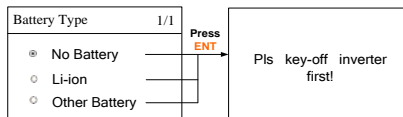

Press ▲/▼ to select the battery type and Press ENT to confirm.
 * Refer to Tab. 7-2 for the explanations, ranges and default values of the parameters.

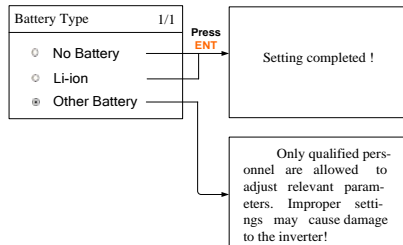

NOTICE

The parameters can only be set by qualified personnel.

Consult battery manufacturer for an advice before any modification.

10.4.4 Setting the Battery Usage Time

When there is no battery equipped in the system, a prompt will appear. **Press ENT** to continue the setting.

For details, see “7.3 Commissioning Procedure”.

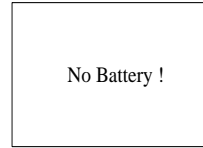

10.4.5 Setting Forced Charge

In the system without a battery, a prompt will appear. **Press ENT** to continue the setting.

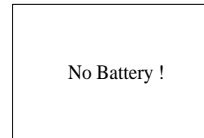

Enable the function for the system with a battery.

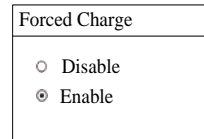

It is recommended to set the time period in off-peak tariff time. The time period 1 is in priority to the time period 2 if two periods overlap. The charging energy comes from the excess PV energy in priority to the energy from the grid. The inverter will sink the charging power from the grid in the case of PV energy shortage.

When there is no PV power, the import power from the grid charges the energy system during the time period until the target SOC is reached.

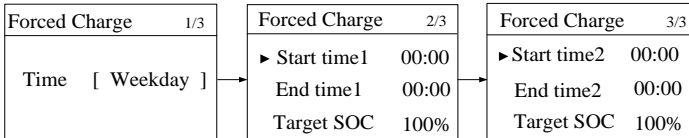

10.4.6 Setting the Protective Parameters

For the function of interface protection system (SPI) for Italy, see “11.2.6 Interface Protection System (SPI)”.

For more parameter settings, please visit the iSolarCloud App or the iSolarCloud server.

When the grid voltage or frequency reaches the recovery value, the corresponding error code displayed on the LCD will be cleared and the inverter can start operating.

▶ Vmax-recover 253.0V Vmin-recover 195.5V	▶ Fmax-recover 51.50Hz Fmin-recover 47.50Hz
--	--

Power Ramp Rate (for countries except Great Britain):
The ramp up/down rate of power variation.
The power rate limit mode is enabled (ON) by default.
Set to OFF to turn off the function.

▶ Power Ramp Rate En. [ON] Power Ramp Rate 010.00%

10-minute over-voltage protection (for countries except Great Britain and Netherlands):
The inverter will automatically disconnect from the grid within 3 s when the average voltage for a 10 min period exceeds the set-point of 10-min Over Vtg.
Set to OFF to turn off the function.

▶ 10-min Over Vtg En. [ON] 10-min Over Vtg 253.0V
--

Tab. 10-2 Protective Parameter Explanations

Parameter	Explanation
Vmax-recover	Recovery value for over-voltage fault. Inverter can start operating only when the grid voltage is below this value.
Vmin-recover	Recovery value for under-voltage fault. Inverter can start operating only when the grid voltage is above this value.
Fmax-recover	Recovery value for over-frequency fault. Inverter can start operating only when the grid frequency is below this value.
Fmin-recover	Recovery value for under-frequency fault. Inverter can start operating only when the grid frequency is above this value.
Power Ramp Rate	The ramp rate of power variation.
10-min Over Vtg	Over-voltage protection value of 10-min average voltage

10.4.7 Setting Reactive Power Regulation

For the modes Qt, Q(P) and Q(U), see “11 Appendix IV: Power Response”.

The PF ranges from 0.8 leading to 0.8 lagging.
Leading: the inverter is sourcing reactive power to the grid
Lagging: the inverter is sinking reactive power from the grid.

Reactive Power	
<input checked="" type="radio"/> OFF	<input type="radio"/> PF
<input type="radio"/> Qt	<input type="radio"/> Q(P)
<input type="radio"/> Q(U)	
PF Setting	
▶ PF	+ 1.000
+ : Lagging & - : Leading	

10.4.8 Setting Active Power Response

For details, see “11.1.4 Over-frequency Response”, “11.2.4 Volt-watt Response” and “11.2.5 Frq-watt Response”.

10.4.9 Setting Load Control

After connecting the load to the DO terminal, a relay control signal will be transmitted. Users can flexibly set the control mode via the LCD menu.

Press ▲/▼ to choose the control mode. Press ENT to confirm.

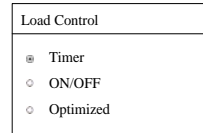

Timer Control

In this mode, set the Start time and End time, the system will control the load operation during the interval. Take 09:00 am–09:30 am as an example.

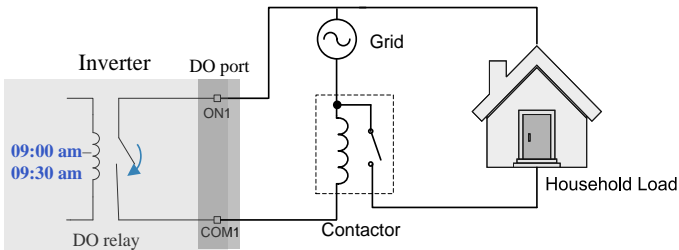
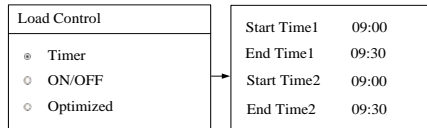
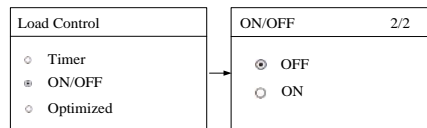

Fig. 10-2 DO Operation in Timer Control

ON/OFF Control

In this mode, the system will control the load operation according to the setting. Set to OFF in the following example.



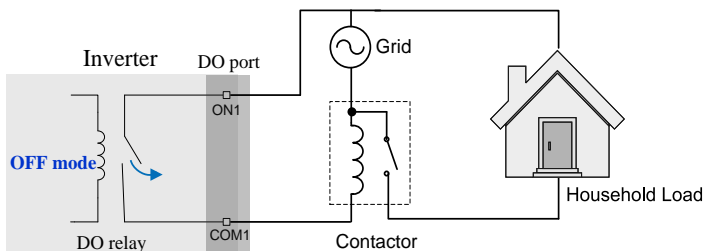

Fig. 10-3 DO Operation in ON/OFF Control

Optimized Control

The system will control the load operation according to the power optimization algorithm of energy management.

During the setting interval, the DO function will be enabled to power on the load if the excess PV energy exceeds the optimized power.

When the existing system is enabled, the upper limit of optimized power is the sum of the rated power of the hybrid inverter and the rated power of the existing PV system.

Once the optimized mode is enabled, the DO relay will not disconnect until 20 minutes after the DO connection.

Load Control	
<input type="radio"/> Timer	
<input type="radio"/> ON/OFF	
<input checked="" type="radio"/> Optimized	

Optimized	P2/2
Start time	09:00
End time	09:30
Power [W]	01000

Take 09:00 am–09:30 am and the optimized power of 1000 W as an example.

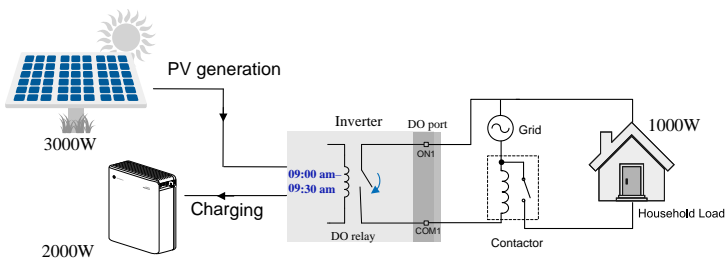

Fig. 10-4 DO Operation in Optimized Control

10.4.10 Setting the Communication Parameters

- Ethernet:

Addr: the communication address ranges from 1 to 247.

DHCP (OFF): the IP, sub net, gateway, DNS1 and DNS2 can be modified only when the DHCP is set to OFF.

DHCP (ON): acquire the IP, subnet mask, gateway, DNS1 and DNS2 from the network automatically.

Server: set the Server to “CLOUD” and the data will be uploaded to www.isolarcloud.com.

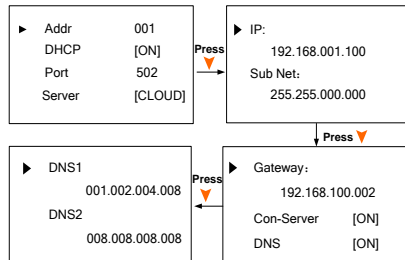
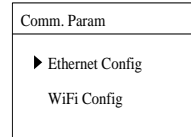

Optional: use the advanced password to check whether the ‘CLOUD’ type is Europe. Please contact SUNGROW for the advanced password.

- Wi-Fi:

Quick Config: press ENT to enable this function and then you can connect the inverter Wi-Fi to your home router quickly.

WiFi Factory Reset: press ENT to remove the router SSID and password recorded in the Wi-Fi.

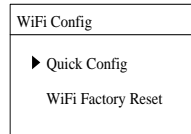

Notes: please contact SUNGROW for the supported Wi-Fi device types.

10.4.11 Testing Earth Fault

The DO2 relay will switch on automatically to signal the external alarm if a light indicator and/or buzzer is connected. The buzzer inside the inverter will also beep.

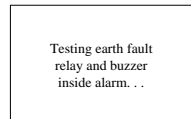

10.4.12 PT1000 Switch Setting

The temperature sampling function of the sensor PT1000 for lead-acid batteries is disabled by default.

Set to *Enable* to turn on the function.

PT1000 Switch	
<input checked="" type="radio"/>	Disable
<input type="radio"/>	Enable

10.4.13 Factory Reset

NOTICE

All history information will be irrecoverably cleared and all parameters will return to the default values except the protection parameters and time once the “Factory Reset” is performed.

Firstly, set the inverter to “OFF” via the LCD menu.

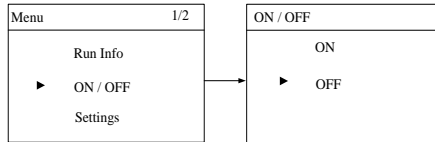

Enter the “Settings” menu and navigate to “Factory Reset”. Press **ENT** to confirm.

Factory Reset	
Confirm factory reset?	

10.5 Setting the Time

The correct system time is very important. If there is deviation between the system time and the local time, the inverter will not operate normally. The clock is in 24-hour format.

DD, **MM**, and **YY** stand for day, month, and year respectively. **hh**, **mm**, and **ss** stand for hour, minute, and second respectively.

▶ Time	hh : mm : ss 07 : 38 : 08
Date	DD / MM / YY 22 / 02 / 15

10.6 Setting the Country

The country setting is protected with a password. Each country code represents corresponding local protective parameters that have been preset before delivery.

Protective parameters are designed for the threshold values that can trigger the protective function of the inverter. The threshold values are compliant with the requirements of local safety standards and the utility grid.

If the protection function is triggered, the inverter will automatically disconnect from the grid with the "Error" status displayed on the LCD main screen. After the grid voltage or frequency recovers to the specified range, the inverter will start running normally and connect to the grid. For the recovery conditions, see "10.4.6 Setting the Protective Parameters".

Press **▲** and Press **ENT** to input the password **111**.

Press **ENT** to confirm the password.

Country
Password: 1 1 1

Only the codes of GB, DE, IT, AT, AU, BE, NL, LUX, CN and SA are supported.



Country
Country: [DE]

Tab. 10-3 Country Code Descriptions

Country Code	Full Name	Language
GB	Great Britain	English
DE	Germany	German
IT	Italy	Italian
AT	Austria	German
AU	Australia	English
BE	Belgium	French
NL	Netherlands	Dutch
LUX	Luxembourg	Dutch
CN	China	Chinese
SA	South Africa	English
Other	Country not included above	English

10.7 Viewing the Error Codes

Viewing the Active Error

For the  icon or the “Error” status on the main screen, **press**  to view the active errors. Refer to “**8.1.2 Errors on the App or LCD Screen**” for the error definition.



Error Active		P1/I
001	GRID	008

Code
Type

Refer to the following table for the error type explanations.

Fault Type	Explanation
GRID	Grid faults (AC side)
PV	PV faults (DC side)
SYS	System faults (inverter)
PER	Permanent faults
WARN	Warnings
BDCF	Faults of battery charge/discharge circuit
BDCPF	Permanent faults of battery charge/discharge circuit
BATW	Battery warnings
BATP	Battery protection
BATF1	Battery faults
BATF2	

Viewing the Error Record

Press / to turn pages and view all error records.

1: the error is triggered.

0: the error is cleared.

Error Record	P1/I	
18022708:55:27	010	0
18022707:11:21	501	1

10.8 Auto Test (Italy)

The inverter is integrated with interface protection functions and provides an auto test system to verify the maximum / minimum frequency and maximum / minimum voltage functions. The “Auto Test” item can only display when the country code is set to “IT” (Italy), so the screenshots introduced in this section will be in Italian.

Press ENT to confirm “Iniziare Autotest” and start the auto test.

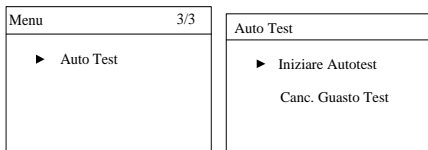

If the inverter is in the status of “Error” or “Turn off”, it cannot start the test and a prompt interface will appear.

Non è possibile di avviare in caso di guasto e tasto di spegnimento!

During normal auto testing, the grid protection testing items will automatically go in the order as follows. The display will return to the main screen with the test normally going if there is no button operation for 2 minutes.

- (1) 81>.S1: over-frequency test (stage I)
- (2) 81<.S1: under-frequency test (stage I)
- (3) 59.S1: over-voltage test (stage I)
- (4) 27.S1: under-voltage test (stage I)
- (5) 81>.S2: over-frequency test (stage II)
- (6) 81<.S2: under-frequency test (stage II)
- (7) 59.S2: over-voltage test (stage II)
- (8) 27.S2: under-voltage test (stage II)

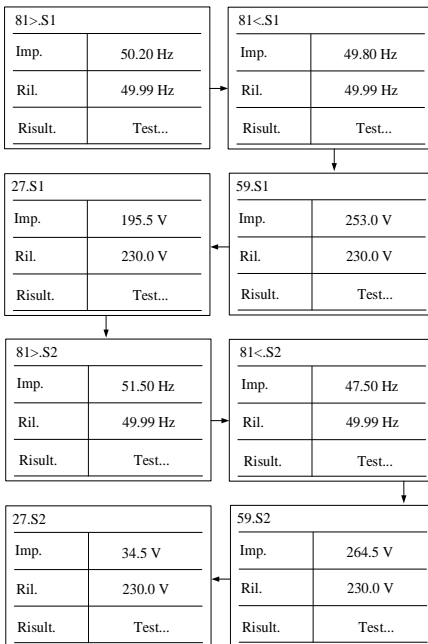

Imp.: the default protection threshold

Ril.: the actual sample value

- For over- frequency / voltage protection testing, the default protection threshold (**Imp.**) is linearly decreased with a ramp ≤ 0.05 Hz/s or ≤ 0.05 Vn/s. The protection function will be triggered if the threshold is lower than the actual sample value (**Ril.**).
- For under- frequency / voltage protection testing, the default protection threshold (**Imp.**) is linearly increased with a ramp ≤ 0.05 Hz/s or ≤ 0.05 Vn/s. The protection function will be triggered if the threshold is higher than the actual sample value (**Ril.**).

If the protection function is triggered, the LED indicator will be lit red and the corresponding error code will be displayed on the main screen. When the test is completed, the interface as shown will appear. **Press** ▼ to view the test result and the trip time.

Completa!	
Imp.	0.0 V
Ril.	0.0 V
Result.	Pass.

NOTICE

Do not press ESC to exit this interface, otherwise the test results will be cleared and you need to do the test again.

For each test, the values of frequency / voltage and the trip times will be visualized as well as the current values of the frequency and voltage measured by the inverter.

Press ▲/▼ to scroll pages and **press ESC** to exit.

The thresholds (**Imp.**) are compliant with standard CEI 0-21 and the actual values (**Ril.**) are for your reference only.

Pass.: The inverter will restore the normally used settings and automatically reconnect to the grid.

Fail: The inverter will report the error **105**. The inverter cannot reconnect to the network until the test faults are cleared.

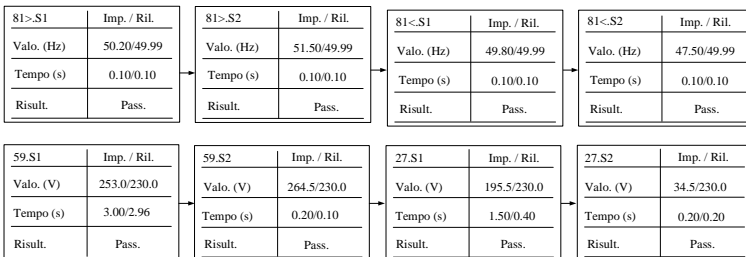

If the auto test fails, **Press ENT** to confirm “Canc. Guasto Test” and clear the test faults.

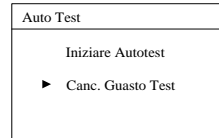

NOTICE

If an external command aimed at changing the frequency protection thresholds is sent to the inverter during the testing process, the test results will be invalid. You should restart the system and re-do the auto test.

11 Appendix IV: Power Response

NOTICE

Only qualified personnel can perform the power regulation settings.

The parameter values indicated are only for your reference. All the parameter settings must comply with local standards.

11.1 For Countries except Italy

Proceed as follows to navigate to the submenu.

Press ▲/▼ to select the desired option and Press ENT to confirm.

For the PF mode, see “10.4.7 Setting Reactive Power Regulation”.

Reactive Power	
<input checked="" type="radio"/> OFF	<input type="radio"/> PF
<input type="radio"/> Qt	<input type="radio"/> Q(P)
<input type="radio"/> Q(U)	

11.1.1 “Qt” Mode

Qt limit: the maximum ratio of reactive power to rated apparent power in %.

The Qt limit ranges from -60.0 % to +60.0 %.

Qt Setting	
▶ Qt Limit	+ 000.0%

11.1.2 “Q(P)” Mode

The PF of the inverter output varies in response to the output power of the inverter. The Q(P) parameters can only be set via the iSolarCloud App or the iSolarCloud server.

Tab. 11-1 “Q(P)” Mode Parameter Explanations

Parameter	Explanation	Default	Range
Leading PF	Power factor of the lower power point	1.000	0.900...1.000
Lagging PF	Power factor of the upper power point	0.950	0.900...1.000
Lower Power*	Lower limit of the output power (in %)	50 %	0...50 %
Upper Power*	Upper limit of the output power (in %)	100 %	50 %...100 %

*Lower Power <Upper Power

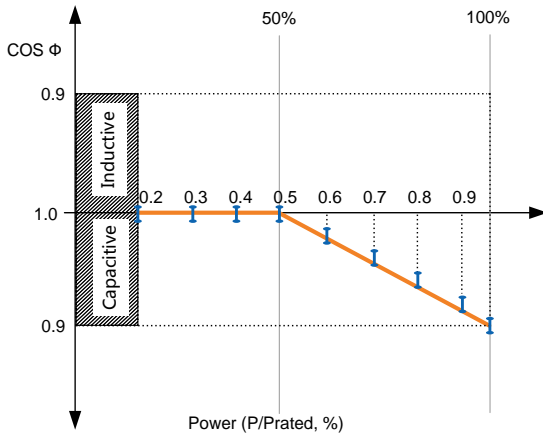

Fig. 11-1 Reactive Power Regulation Curve in Q(P) Mode

11.1.3 “Q(U)” Mode

Define the response curve with four grid voltages, leading Q/Sn of the lower limit point and lagging Q/Sn of the upper limit point. The reactive power output of the inverter will vary in response to the grid voltage.

The Q(U) parameters can only be set via the iSolarCloud App or the iSolarCloud server.

Tab. 11-2 “Q(U)” Mode Parameter Explanations

Parameter	Description
V1 Ref.	Grid voltage limit (in %) of point P1 in the Q(U) mode curve
V2 Ref.	Grid voltage limit (in %) of point P2 in the Q(U) mode curve
V3 Ref.	Grid voltage limit (in %) of point P3 in the Q(U) mode curve
V4 Ref.	Grid voltage limit (in %) of point P4 in the Q(U) mode curve
Leading Q/Sn	Leading Q/Sn value of point P1 in the Q(U) mode curve
Lagging Q/Sn	Lagging Q/Sn value of point P4 in the Q(U) mode curve
Hysteresis*	Hysteresis voltage width (in %)

* V2 Ref. + Hysteresis < V3 Ref. Hysteresis

Tab. 11-3 “Q(U)” Mode Parameter Values

Parameter	DE		BE, LUX, NL	
	Default	Range	Default	Range
V1 Ref.	93 %	80 %...94 %	90 %	90 %...92 %
V2 Ref.	97 %	95 %...100 %	92 %	92 %...100 %
V3 Ref.	103 %	100 %...105 %	108 %	100 %...108 %
V4 Ref.	107 %	106 %...120 %	110 %	108 %...110 %

Parameter	DE	BE, LUX, NL
Leading Q/Sn	60 %	0...60 %
Lagging Q/Sn	60 %	0...60 %
Hysteresis	0 %	0...50 %

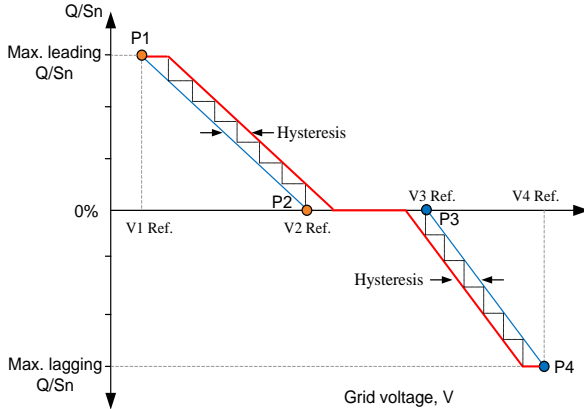

Fig. 11-2 Reactive Power Control Curve in Q(U) Curve

11.1.4 Over-frequency Response

The *Volt-watt* mode and *Volt-watt (Chrg)* mode are not supported!

Press **▼** to select *Frq-watt* and Press **ENT** to confirm.

Active Power	
▶	Volt-watt
	Frq-watt
	Volt-watt (Chrg)

Tab. 11-4 Definition of Over-frequency Response Parameters

Parameter	Description
OverFrq Start	The Start frequency value for over-frequency response.
OverFrq End	The Stop frequency value for over-frequency response.
Pm	The actual AC output power at the instance when the frequency reaches the Start frequency.
Gradient	The active power reduction rate relative to the actual power Pm per Hz.

When there is an increase in grid frequency which exceeds the Start value (default of 50.20 Hz), the inverter will reduce the power output linearly with a gradient of 40% Pm/Hz until the End value (default of 51.50 Hz) is reached.

When the frequency exceeds the End value, the

▶	OverFrq Start	50.20 Hz
	OverFrq End	51.50 Hz

inverter output shall be ceased (i.e. 0 W).

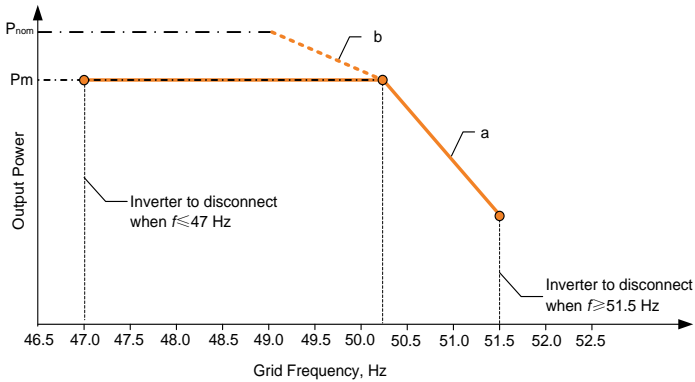

Fig. 11-3 Frq-Watt Mode for Over-frequency Conditions

Between the Start value and the End value, all adjustable power generation systems shall reduce (for frequency increase) or increase (for frequency decrease) the active power P_m generated instantaneously, as shown on the curve a.

If the grid frequency drops again to a value below the value of OverFrq Start and if the possible generation power at that instant is greater than the active power P_m , the increase of the active power supplied to the grid will not exceed a gradient of 10 % of the maximum active power per minute, as shown on the curve b.

11.2 For Italy (“IT”)

11.2.1 “Qt” Mode

Qt limit: the maximum ratio of reactive power to rated apparent power in %.
 The Qt limit ranges from -60.0 % to +60.0 %.

Qt Setting	
▶ Qt Limit	+ 000.0%

11.2.2 “Q(P)” Mode

The PF of the inverter output varies in response to the output power of the inverter.

▶ PA	020.0%	Uin	105.0%
PB	050.0%	Uout	100.0%
PC	100.0%		
Max PF	0.900		

Tab. 11-5 Italy “Q(P)” Mode Parameters Explanation

Parameter	Explanation	Default	Range
PA	Active power at point A (in %)	20 %	20 %...100 %
PB	Active power at point B (in %)	50 %	20 %...100 %
PC	Active power at point C (in %)	100 %	20 %...100 %
Max. PF	Power factor at point C	0.900	0.900...1.000
Uin	Enter into the Q(P) regulation mode when the grid voltage is above Uin	105 %	100 %...110 %
Uout	Exit from the Q(P) regulation mode when the grid voltage is below Uout	100 %	90 %...100 %

* PA < PB ≤ PC, Uin > Uout

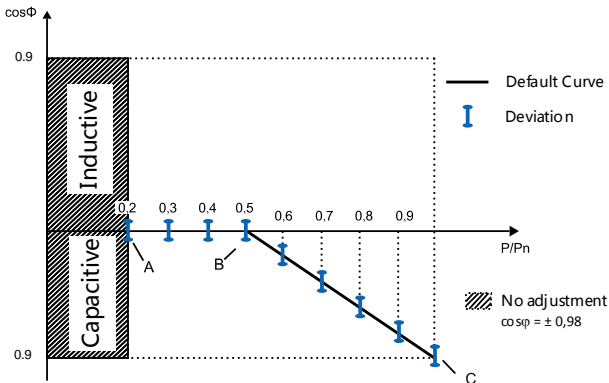

Fig. 11-4 Reactive Power Regulation Curve in “IT” Q(P) Mode

11.2.3 “Q(U)” Mode

Define the response curve with four grid voltages. The reactive power output of the inverter will vary in response to the grid voltage.

The Q(U) parameters can only be set via the iSolarCloud App or the iSolarCloud server.

Tab. 11-6 Italy “Q(U)” Mode Parameters Explanation

Parameter	Explanation	Default	Range
V2i*	Grid voltage at point A (in %)	90 %	90 %...110 %
V1i*	Grid voltage at point B (in %)	92 %	90 %...110 %
V1s*	Grid voltage at point C (in %)	108 %	90 %...110 %
V2s*	Grid voltage at point D (in %)	110 %	90 %...110 %
k	The ratio of the base reactive power (in %)	0 %	0...100 %
Pin**	Enter into the Q(U) regulation mode when the power is above Pin	20 %	20%...100%
Pout**	Exit from the Q(U) regulation mode when the power is below Pout	5 %	1 %...20 %
Qmax	The max. ratio of reactive power (in %)	48.4 %	0...60 %

*V2i < V1i < V1s < V2s

**Pin > Pout

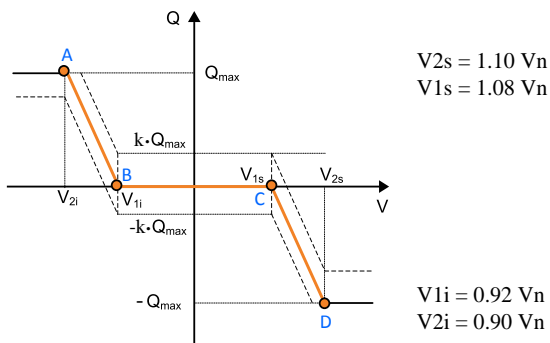
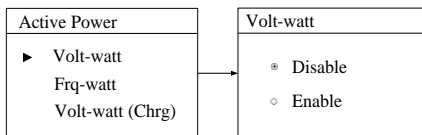

Fig. 11-5 Reactive Power Regulation Curve in “IT” Q(U) Mode

11.2.4 Volt-watt Response

Press **ENT** to confirm the choice. The active power reduction function for voltage values is disabled by default.



If the function is enabled, the active power output will be reduced when the grid voltage stated on the LCD screen has a value higher than 112 % V_n (nominal voltage). The charge power drawn from the grid will be at least equal to 80 % * P_{cm_{ax}}, within 5 minutes, where the P_{cm_{ax}} is the maximum charge power of the system.

When the grid voltage falls lower than 108 % V_n, the inverter will response and the active power output will return then to the values consistent with the power available by the DC side.

11.2.5 Frq-watt Response

Press **▼** to select *Frq-watt* and Press **ENT** to confirm.

Active Power	
Volt-watt	
▶	Frq-watt
Volt-watt (Chrg)	
▶ OverFrq Start 50.20 Hz	
OverFrq End 51.50 Hz	
▶ UnderFrq Start 49.80 Hz	
UnderFrq End 49.10 Hz	
▶ Frq Adj. Delay 0.20 s	

The variation of the active power generated by the system will take place for exceeding of the threshold values in the over-frequency adjustable between 50 and 52 Hz (default of 50.2 Hz).

The variation of the active power absorbed by the system will take place for exceeding of the threshold values in the under-frequency adjustable between 47 and 50 Hz (default of 49.8 Hz).

The power control of function active for transient over- and under-frequency has an activation delay can be set from 0 to 1s with 50 ms steps (default of 0.20 s).

The quadrilateral in the following figure shows the active power control in the conditions of over- and under-frequency. The area included in the central rectangular zone defines the possible points of normal operation in which the storage system may be at work and from these points the system will have to change its active power and move to the vertices of the quadrilateral according to the thresholds of over- or under-frequency (see dashed lines).

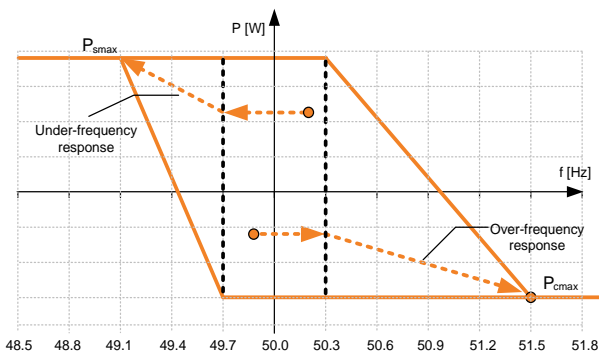

Fig. 11-6 Control of Active Power in Conditions of Over- and under-frequency

* P_{smax} : the maximum discharge power; P_{cmax} : the maximum charge power

When the grid frequency returns back to 50 ± 0.1 Hz (default setting) for a minimum continuous time of 300 s, the system will end the frequency response and return to its ordinary operation linearly with a transitional time not less than 300 s, as shown in the figure below.

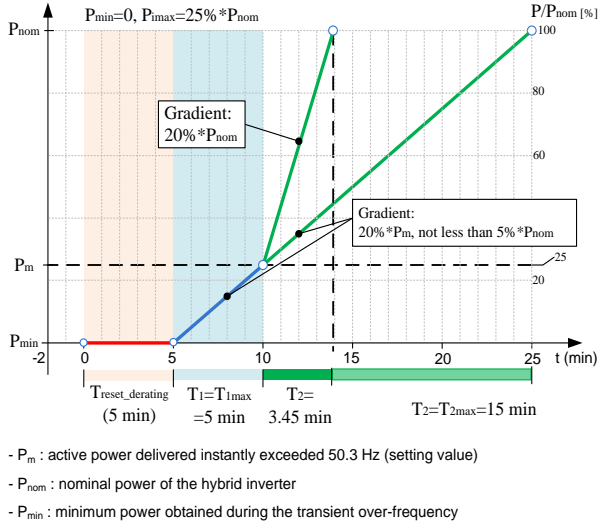
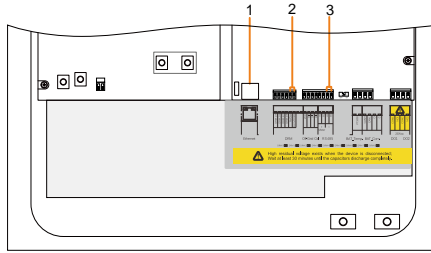

Fig. 11-7 Power Restoration in Condition of Transient Over-frequency

11.2.6 Interface Protection System (SPI)

The inverter has integrated the interface protection system (SPI) to provide the following functions:

- Maximum/minimum frequency protection;
- Ability to receive signals aimed at changing the frequency protection thresholds and to receive the command of remote shutdown.



NO.	Interface	SPI Function
1	Ethernet	Receive external signal/command to change the frequency protection parameters or shutdown the inverter. See "6.5.1 Ethernet Connection" for the cable connection.
2	RefGen, Com/DRM0	Shortly connecting the two terminals will change the frequency protection parameters. See Fig. 11-8.
3	A1, B1	Receive external command to shutdown the inverter remotely. See Fig. 11-9.

The following figure shows the cable connection to external device.

Cross-section: 2*0.5 mm², cable diameter: 3 mm...5.3 mm

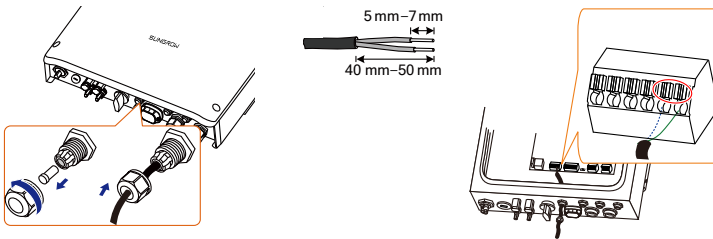

Fig. 11-8 RefGen and Com/DRM0 Connection

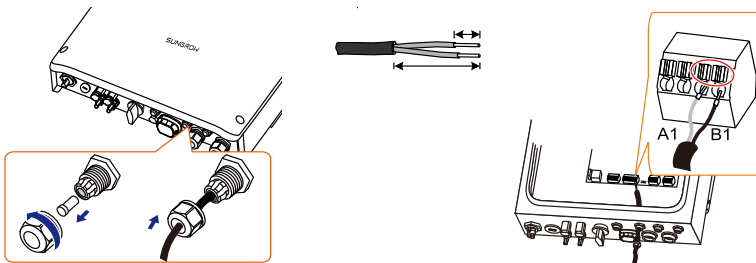

Fig. 11-9 RS485 Connection to External Device

Note:

For reconnection, press the part as shown in the red circle so as to pull out the cable.

Local Control

In this mode, the inverter is in the absence of a communication “always on” prepared by the distributor. Through the local control via *RefGen* and *Com/DRM0* terminals:

- Low (state value 0): two terminals are not connected and you can get permanent operation at permissive thresholds;
- High (state value 1): two terminals are connected and you can get permanent operation at restrictive thresholds;

External Control

In this mode, the inverter is connected with the external device via an Ethernet cable. Through the external signal:

- Low (state value 0) in case of really operating communication
- High (state value 1) in case of external commands sent by the external device

Note: The local control must be set permanently in the high state (value 1).

Tab. 11-7 Frequency Protection Parameters in Conditions of SPI

Explanation	Local Control		External Control	
	0	1	0	1
Minimum frequency 1 (F<) (Hz)	47.50	49.80	47.50	49.80
Minimum frequency 1 (F<) tripping time (s)	0.1	0.1	4.0	0.1
Minimum frequency 2 (F<<) (Hz)	47.50	47.50	47.50	47.50
Minimum frequency 2 (F<<) tripping time (s)	0.1	0.1	4.0	4.0
Maximum frequency 1 (F>) (Hz)	51.50	50.20	51.50	50.20
Maximum frequency 1 (F>) tripping time (s)	0.1	0.1	1.0	0.1
Maximum frequency 2 (F>>) (Hz)	51.50	51.50	51.50	51.50
Maximum frequency 2 (F>>) tripping time (s)	0.1	0.1	1.0	1.0



- The default mode of SPI is local control with low state value 0 (no connection between *RefGen* and *Com/DRM0* terminals).
- When the local control and external control modes exist at the same time, the external control mode takes priority over the local control mode.

12 Appendix V: Technical Data

12.1 Inverter

Input Data	SH3K6	SH4K6
Max. PV input power	6500 W	6500 W
Max. PV input voltage	600 V	600 V
Startup voltage	125 V	125 V
Nominal input voltage	360 V	360 V
MPP voltage range	125 V...560 V	125 V...560 V
MPP voltage range for nominal power	180 V...520 V	220 V...520 V
No. of MPPTs	2	2
Max. number of PV strings per MPPT (DC1/DC2)	1 / 1	1 / 1
Max. PV input current (DC1/DC2)	11 A / 11 A	11 A / 11 A
Max. current for input terminals	12 A / 12 A	12 A / 12 A
Short circuit current of PV input	12 A / 12 A	12 A / 12 A
Max. inverter backfeed current to array	0 A	0 A
Battery Data		
Battery type	Li-ion battery / Lead-acid battery	
Battery voltage (rated voltage / range)	48 V (32 V...70 V)	
Max. charging / discharging current	65 A / 65 A	
AC Input and Output Data		
Nominal AC output power to grid	3680 W	4600 W
Max. AC output apparent power to grid	3680 VA ⁽¹⁾	4600 VA ⁽²⁾
Max. AC input power from grid	3000 W	3000 W
Nominal AC output current	16 A	20 A
Max. AC output current	16 A	20 A
Max. inrush current (peak / duration)	10 A / 12 ms	10 A / 12 ms
Max. output fault current (peak / duration)	100 A / 3.2 ms	100 A / 3.2 ms
Max. output over-current protection	32 A	32 A
Nominal grid voltage	230 Vac	
Grid voltage range	180 Vac...276 Vac	
Nominal grid frequency	50 Hz	
Grid frequency range	45 Hz...55 Hz	
Total Harmonic Distortion (THD)	< 3 % (of nominal power)	
DC current injection	< 0.5 % (of nominal current)	

Power factor	> 0.99 at default value at nominal power (adj. 0.8 overexcited / leading-0.8 underexcited / lagging)	
Protection		
Anti-islanding protection	Yes	
AC short circuit protection	Yes	
Leakage current protection	Yes	
Low voltage fault ride through (LVRT)	Yes	
DC switch (solar)	Yes	
DC fuse (solar)	No	
DC fuse (battery)	Yes	
Over-voltage category	III [Main], II [PV] [Battery]	
System Data		
Max. efficiency	97.7 %	97.7 %
Max. European efficiency	97.0 %	97.2 %
Max. charge / discharge efficiency	94.0 %	94.0 %
Isolation method (solar)	Transformerless	
Isolation method (battery)	HF	
Ingress protection (IP) rating	IP65	
Power loss in night mode	< 1 W	
Operating ambient temperature	-25°C...60°C (> 45°C derating)	
Relative humidity (non-condensing)	0...100 %	
Cooling method	Natural convection	
Max. operating altitude	2000 m	
Display	Graphic LCD	
Communication	2 x RS485, Ethernet, Wi-Fi (optional), CAN	
Analogue input	PT1000	
Power management	1 x Digital output	
Earth fault alarm	1 x Digital output, email, buzzer inside	
PV connection type	MC4	
AC connection type	Clamping yoke connector	
Certificates and approvals	VDE-AR-N-4105, DIN VDE0126-1-1, G83/2, G59/3, CEI 0-21, IEC 62109-1, IEC62109-2, IEC 62116, EN 62477-1, EN 61000-6-1/-3	

Mechanical Data	
Dimensions (W x H x D)	457 mm x 515 mm x 170 mm
Mounting method	Wall-mounting bracket
Weight	22 kg

For the Q(P) mode in Italy, when the PF is 0.90 and the active power is 100 %,

- (1) SH3K6: the maximum AC output apparent power to grid is 4000 VA.
- (2) SH4K6: the maximum AC output apparent power to grid is 5110 VA.

12.2 Energy Meter

Item	Single-phase	Three-phase
Nominal voltage	240 Vac	3 x 230 Vac / 400 Vac
Input voltage range	180 Vac...286 Vac	3 x 180 / 311 Vac... 3 x 268 / 464 Vac
Power consumption	< 2 W (10 VA)	< 2 W (10 VA)
Max. operating current	100 A	3 x 10 (80) A
Grid frequency	50 Hz	
Measurement accuracy	Class I	
Interface and communication	RS485	
Ingress protection rating	IP20	
Operating ambient temperature	-25°C...+75°C	-25°C...+55°C
Relative humidity	0...95 % (no condensation)	
Mounting method	35 mm DIN-rail	
Dimensions (W x H x D)	18 x 117 x 65 (mm)	127 x 70 x 89 (mm)
Weight	0.2 kg	0.35 kg

12.3 Quality Assurance

When product faults occur during the warranty period, SUNGROW will provide free service or replace the product with a new one.

Evidence

During the warranty period, the customer shall provide the product purchase invoice and date. In addition, the trademark on the product shall be undamaged and legible. Otherwise, SUNGROW has the right to refuse to honor the quality guarantee.

Conditions

- After replacement, unqualified products shall be processed by SUNGROW.

- The customer shall give SUNGROW a reasonable period to repair the faulty device.

Exclusion of Liability

In the following circumstances, SUNGROW has the right to refuse to honor the quality guarantee:

- If the free warranty period for the whole machine/components have expired.
- If the device is damaged during transport.
- If the device was incorrectly installed, refitted, or used.
- If the device is operated in a very improper environment, as described in this manual.
- If the fault or damage was caused by installation, repairs, modification, or disassembly performed by a service provider or personnel other than this company.
- If the fault or damage was caused by the use of non-standard or non-SUNGROW components or software.
- If the installation and use range are beyond stipulations of relevant international standards.
- If the damage was caused by an abnormal natural environment.

For faulty products in any of above cases, if the customer requests maintenance, paid maintenance service may be provided based on the judgment of SUNGROW.

Software Licenses

- It is prohibited to use data contained in firmware or software developed by SUNGROW, in part or in full, for commercial purposes by any means.
- It is prohibited to reverse engineer, crack, or perform any other operations that compromise the original program design of the software developed by SUNGROW.

Contact Information

Should you have any question about this product, please contact us.

We need the following information to provide you the best assistance:

- Type of the inverter

- Serial number of the inverter
- Error code/name
- Brief description of the problem

China (HQ)

Sungrow Power Supply Co., Ltd
 Hefei
 +86 551 65327834
service@sungrowpower.com

Australia

Sungrow Australia Group Pty.
 Ltd.
 Sydney
 +61 2 9922 1522
service@sungrowpower.com.au

Brazil

Sungrow Do Brasil
 Sao Paulo
 +55 11 2366 1957
latam.service@sa.sungrowpower.com

France

Sungrow France
 Lyon
 +33420102107
service@sungrow-emea.com

Germany, Austria, Switzerland

Sungrow Deutschland GmbH
 Munich
 +49 0800 4327 9289
service@sungrow-emea.com

Greece

Service Partner – Survey Digital
 +30 2106044212
service@sungrow-emea.com

India

Sungrow (India) Private Limited
 Gurgaon
 +91 080 41201350
service@in.sungrowpower.com

Italy

Sungrow Italy
 Verona
 +39 0800 974739 (Residential)
 +39 045 4752117 (others)
service@sungrow-emea.com

Japan

Sungrow Japan K.K.

Tokyo

+81 3 6262 9917

service@jp.sungrowpower.com**Korea**

Sungrow Power Korea Limited

Seoul

+82 70 7719 1889

service@kr.sungrowpower.com**Malaysia**

Sungrow SEA

Selangor Darul Ehsan

+60 19 897 3360

service@my.sungrowpower.com**Philippines**

Sungrow Power Supply Co., Ltd

Mandaluyong City

+63 9173022769

service@ph.sungrowpower.com**Thailand**

Sungrow Thailand Co., Ltd.

Bangkok

+66 891246053

service@th.sungrowpower.com**Spain**

Sungrow Ibérica S.A.U.

Mutilva

+34 948 05 22 04

service@sungrow-emea.com**Romania**

Service Partner - Elerex

+40 241762250

service@sungrow-emea.com**Turkey**Sungrow Deutschland GmbH
Turkey

Istanbul

+90 216 663 61 80

service@sungrow-emea.com**UK**

Sungrow Power UK Ltd.

Milton Keynes

+44 (0) 01908 414127

service@sungrow-emea.com**U.S.A, Mexico**

Sungrow USA Corporation

Phoenix

+1 833 747 6937

techsupport@sungrow-na.com**Vietnam****Belgium, Netherlands and**

Sungrow Vietnam

Hanoi

+84 918 402 140

service@vn.sungrowpower.com

Luxembourg (Benelus)

+31 08000227012 (only for Netherlands)

service@sungrow-emea.com

Poland

-

+48 221530484

service@sungrow-emea.com
